

**DO-15**

**Features**

- ✧ Plastic package has Underwriters Laboratory Flammability Classification 94V-0
- ✧ Typical  $I_R$  less than 1uA
- ✧ High temperature soldering guaranteed: 260°C / 10 seconds
- ✧ Green compound with suffix "G" on packing code & prefix "G" on datecode

**Mechanical Data**

- ✧ Case: DO-15
- ✧ Terminals: Pure tin plated, lead free, solderable per MIL-STD-750, method 2026
- ✧ Polarity: Indicated by cathode band
- ✧ Weight: 0.4 grams

**Ordering Information (example)**

Part No.	Package	Packing	INNER TAPE	Packing code	Packing code (Green)
2M6.8Z	DO-15	1.5K / AMMO box	52mm	A0	A0G

**Maximum Ratings and Electrical Characteristics**

Rating at 25 °C ambient temperature unless otherwise specified.

Parameter	Symbol	Value	Units
Steady State Power Dissipation at $T_L=75^\circ\text{C}$ Lead Lengths .375", 9.55mm (Note 1)	$P_D$	2.0	Watts
Peak Forward Surge Current, 8.3ms Single Half Sine-wave Superimposed on Rated Load (JEDEC method) (Note 2)	$I_{FSM}$	15	Amps
Operating and Storage Temperature Range	$T_J, T_{STG}$	-55 to +175	°C

Note 1: Mount on Cu-Pad size 10mm x 10mm x 1.6mm on PCB

Note 2: Measured on 8.3ms Single half Sine-Wave of equivalent square wave, duty cycle= 4 pulse per minute maximum





**ELECTRICAL CHARACTERISTICS (TA=25°C unless otherwise noted)**

Device (Notes 1)	Nominal Zener Voltage (Notes 2)	Test Current	Maximum Zener Impedance (Notes 3)			Leakage Current		Maximum Zener Current
	V <sub>Z</sub> @ I <sub>ZT</sub>	I <sub>ZT</sub>	Z <sub>ZT</sub> @ I <sub>ZT</sub>	Z <sub>ZK</sub> @ I <sub>ZK</sub>	I <sub>ZK</sub>	I <sub>R</sub> @ V <sub>R</sub>		I <sub>ZM</sub>
	V	mA	Ω	Ω	mA	uA	V	mA
2M6.8Z	6.8	100	1.5	200	1.00	1000	5.5	246
2M11Z	11	45.5	4.0	700	0.25	1.0	8.4	166
2M12Z	12	41.5	4.5	700	0.25	1.0	9.1	152
2M13Z	13	38.5	5.0	700	0.25	0.5	9.9	138
2M14Z	14	35.7	5.5	700	0.25	0.5	10.6	130
2M15Z	15	33.4	7.0	700	0.25	0.5	11.4	122
2M16Z	16	31.2	8.0	700	0.25	0.5	12.2	114
2M17Z	17	29.4	9.0	750	0.25	0.5	13.0	107
2M18Z	18	27.8	10	750	0.25	0.5	13.7	100
2M19Z	19	26.3	11	750	0.25	0.5	14.4	95
2M20Z	20	25.0	11	750	0.25	0.5	15.2	90
2M22Z	22	22.8	12	750	0.25	0.5	16.7	82
2M24Z	24	20.8	13	750	0.25	0.5	18.2	76
2M27Z	27	18.5	18	750	0.25	0.5	20.6	68
2M30Z	30	16.6	20	1000	0.25	0.5	22.8	60
2M33Z	33	15.1	23	1000	0.25	0.5	25.1	55
2M36Z	36	13.9	25	1000	0.25	0.5	27.4	50
2M39Z	39	12.8	30	1000	0.25	0.5	29.7	47
2M43Z	43	11.6	35	1500	0.25	0.5	32.7	43
2M47Z	47	10.6	40	1500	0.25	0.5	35.8	39
2M51Z	51	9.8	48	1500	0.25	0.5	38.8	36
2M56Z	56	9.0	55	2000	0.25	0.5	42.6	32
2M62Z	62	8.1	60	2000	0.25	0.5	47.1	29
2M68Z	68	7.4	75	2000	0.25	0.5	51.7	27
2M75Z	75	6.7	90	2000	0.25	0.5	56.0	24
2M82Z	82	6.1	100	3000	0.25	0.5	62.2	22
2M91Z	91	5.5	125	3000	0.25	0.5	69.2	20
2M100Z	100	5.0	175	3000	0.25	0.5	76.0	18
2M110Z	110	4.5	250	4000	0.25	0.5	83.6	17
2M120Z	120	4.2	325	4500	0.25	0.5	91.2	15
2M130Z	130	3.8	400	5000	0.25	0.5	98.8	14
2M140Z	140	3.6	500	5500	0.25	0.5	106.4	13
2M150Z	150	3.3	575	6000	0.25	0.5	114.0	12
2M160Z	160	3.1	650	6500	0.25	0.5	121.6	11
2M170Z	170	2.9	675	7000	0.25	0.5	130.4	11
2M180Z	180	2.8	725	7000	0.25	0.5	136.8	10
2M190Z	190	2.6	825	8000	0.25	0.5	144.8	10
2M200Z	200	2.5	900	8000	0.25	0.5	152.0	9

Notes:

1. TOLERANCES - Standard Voltage tolerance = ±5%, tolerances may be considered as a special device
2. ZENER VOLTAGE(V<sub>Z</sub>) MEASUREMENT - Zener voltage guaranteed when measured at 0.375"(9.5mm) from the body under 40ms ±10ms current pulse and ambient temperature of 25°C
3. ZENER IMPEDANCE (Z<sub>Z</sub>) DERIVATION - The zener impedance is derived from 60 cycles AC voltage, which results when an current having an rms value equal to 10% of the DC zener current (I<sub>ZT</sub> or I<sub>ZK</sub>) is superimposed on I<sub>ZT</sub> or I<sub>ZK</sub>
4. MAXIMUM ZENER CURRENT (I<sub>ZM</sub>) NON-REPETITIVE - The rating listed in the electrical characteristics table is maximum peak non - repetitive reverse surge current of 1/2 sine wave of 1/120 second duration or equivalent square wave, superimposed on the test current I<sub>ZT</sub>, per JEDEC standard.

RATINGS AND CHARACTERISTIC CURVES (2M6.8Z THRU 2M200Z)

FIG. 1- TYPICAL THERMAL RESPONSE

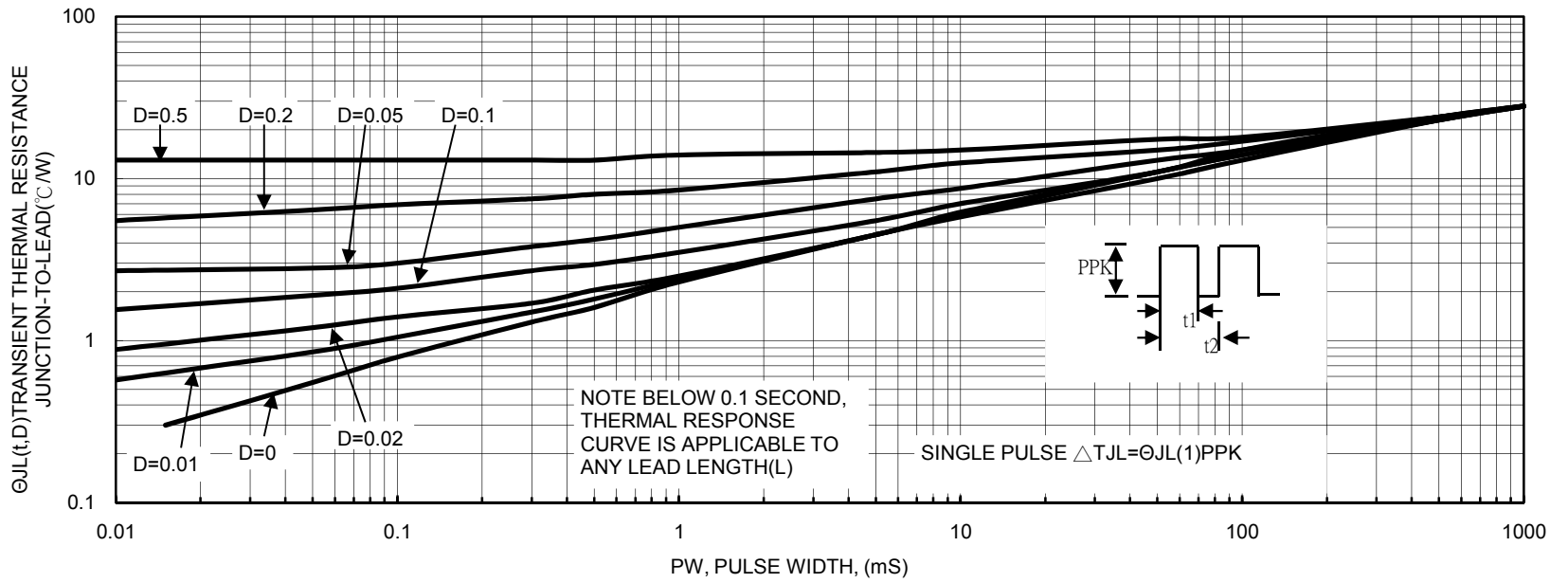

FIG. 2- MAXIMUM SURGE POWER

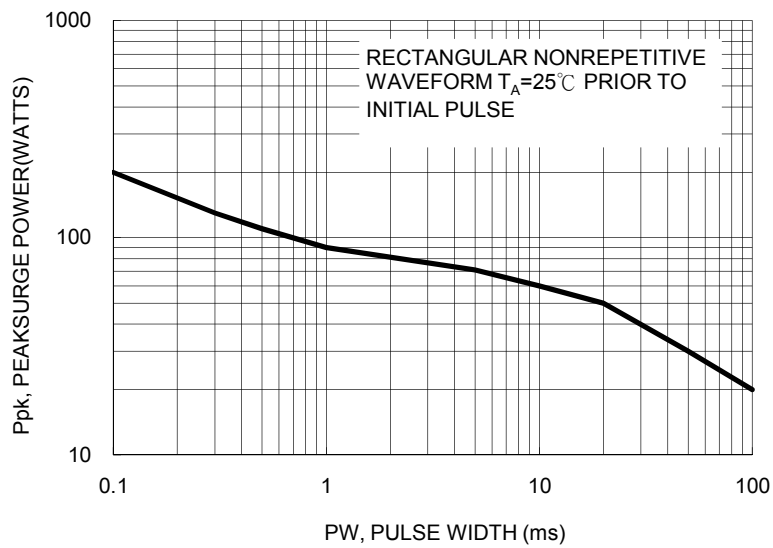

FIG. 3- TYPICAL REVERSE LEAKAGE

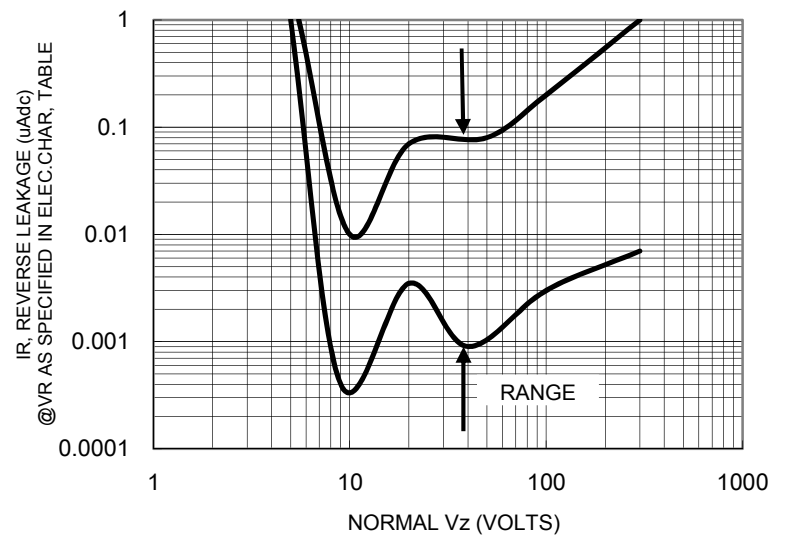

FIG.4- UNIT 6.8 TO 12 VOLTS

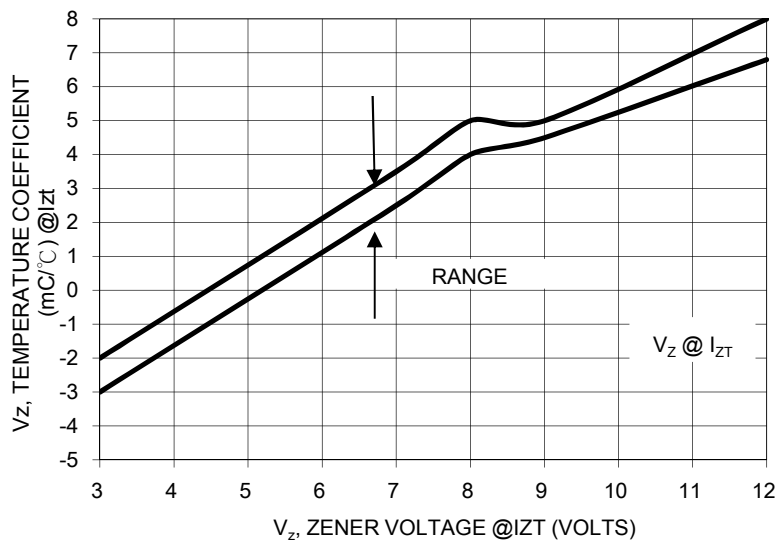
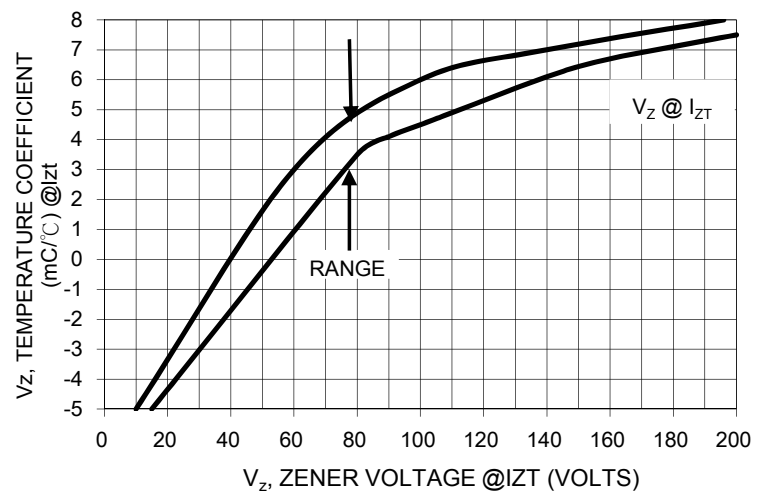

FIG.5 UNIT 13 TO 200 VOLTS



RATINGS AND CHARACTERISTIC CURVES (2M6.8Z THRU 2M200Z)

FIG. 6-  $V_z = 6.8$  THRU 10 VOLTS

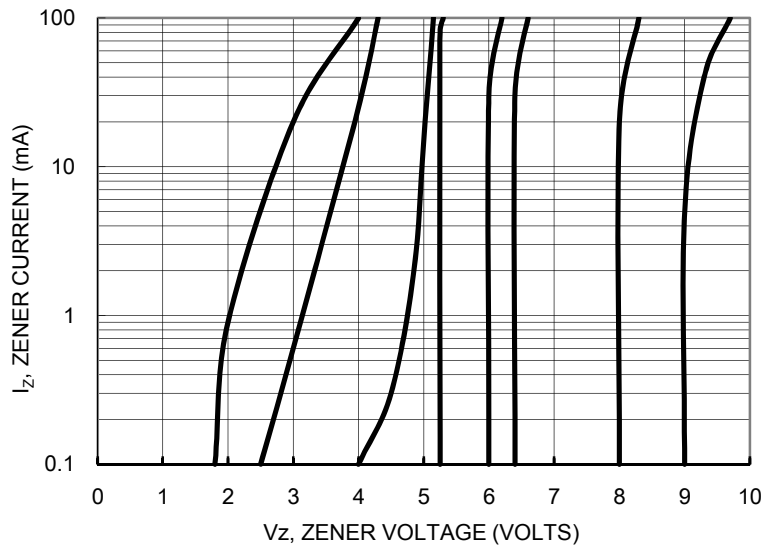

FIG. 7-  $V_z = 11$  THRU 91 VOLTS

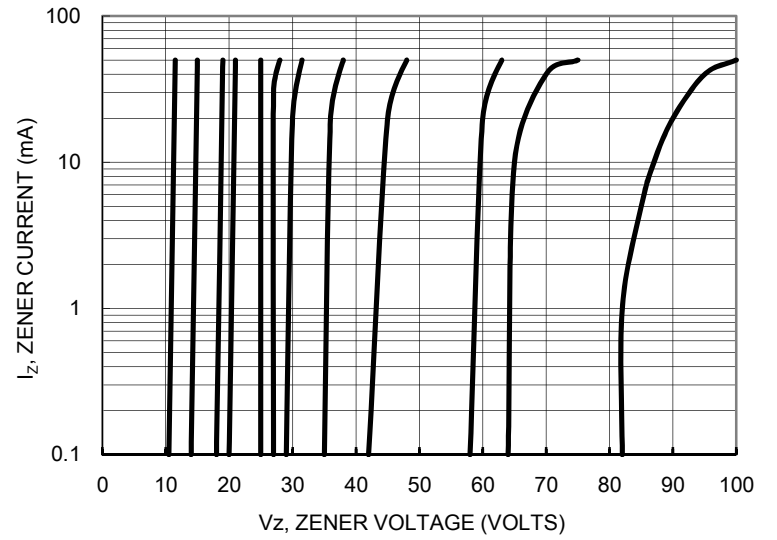

FIG. 8-  $V_z = 100$  THRU 200 VOLTS

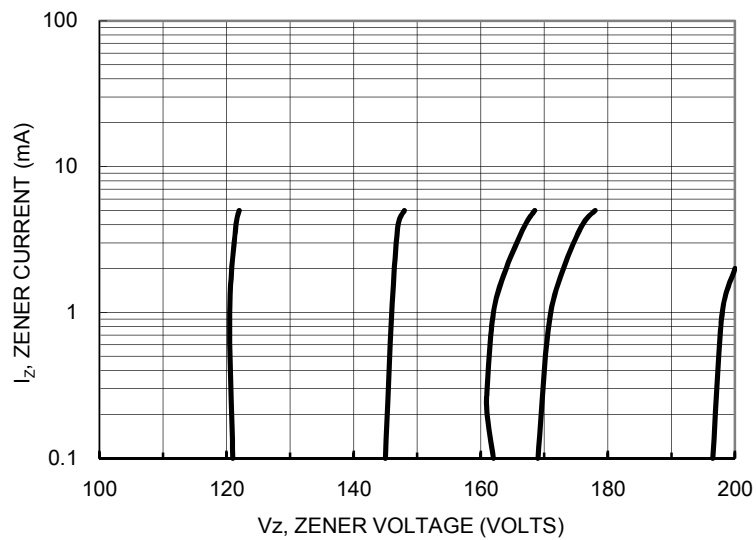
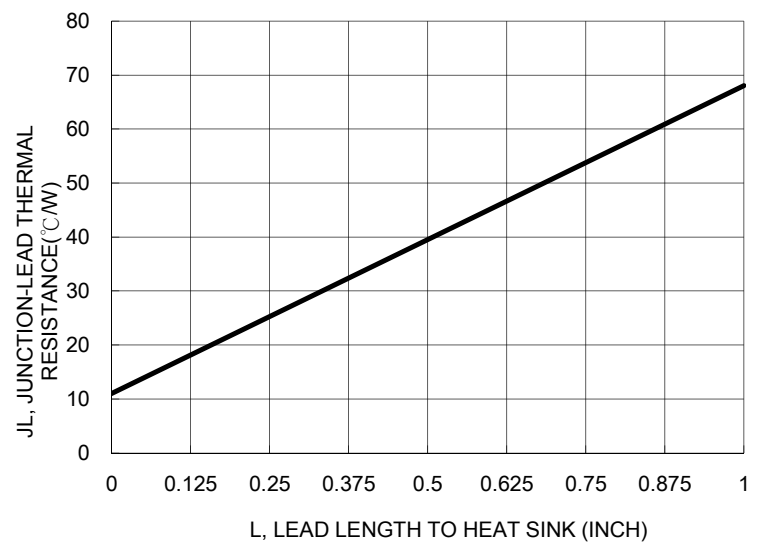

FIG. 9- TYPICAL THERMAL RESISTANCE



### Ordering information

Part No.	Package	Packing	INNER TAPE	Packing code	Packing code (Green)
2MxxZ (Note)	DO-15	1.5K / AMMO box	52mm	A0	A0G
	DO-15	3.5K / 13" Reel	52mm	R0	R0G
	DO-15	1K / Bulk packing		B0	B0G

Note: "xx" is Device Code from "6.8" thru "200".

### AXIAL LEAD TAPING SPECIFICATIONS

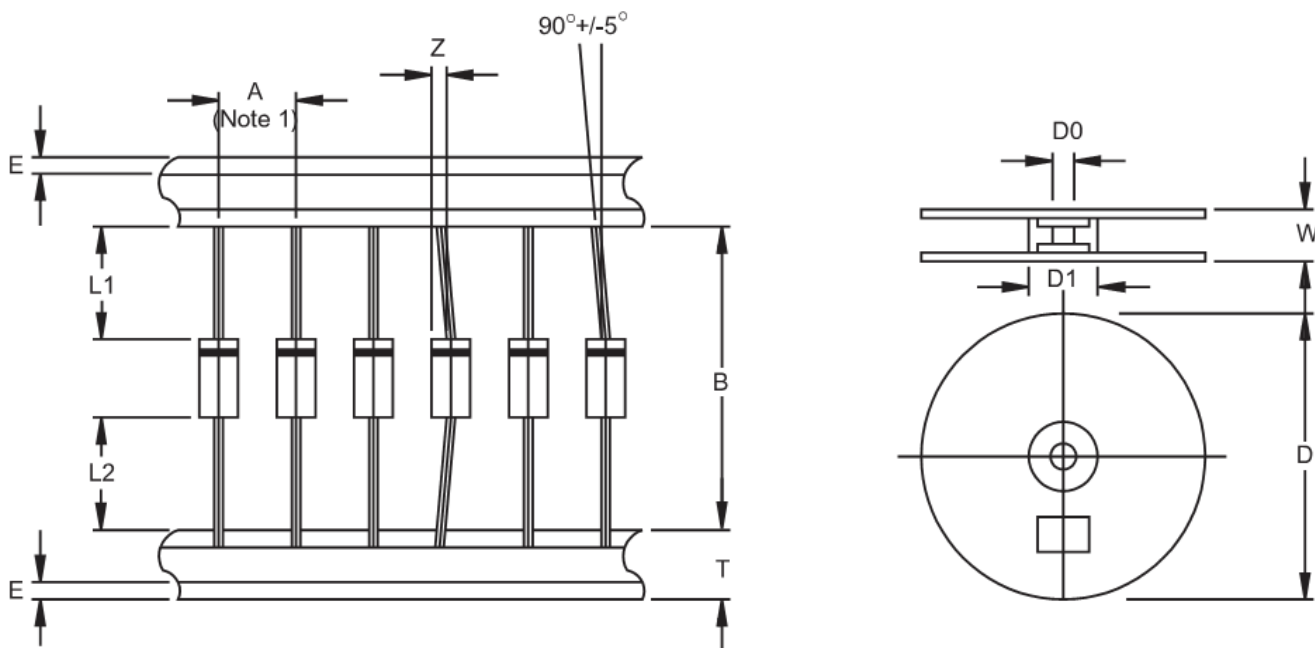

Outline	A	B	Z	T	E	L1-L2	D	D1	D0	W
	DO-15	±0.5	±1.5	MAX	±0.4	MAX	MAX		±0.3	±0.4

Unit (mm)

### Suggested Mounting Hole Rule

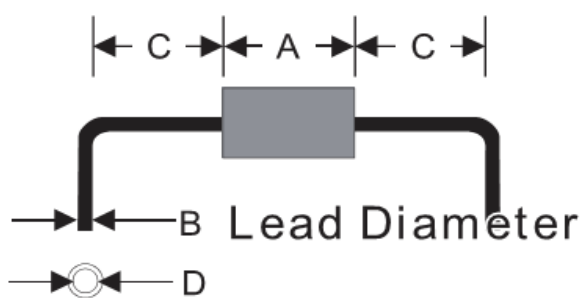

Symbol	Unit(mm)
A	6.4
B	0.8
C	3.0
D	1.2

**Dimensions**

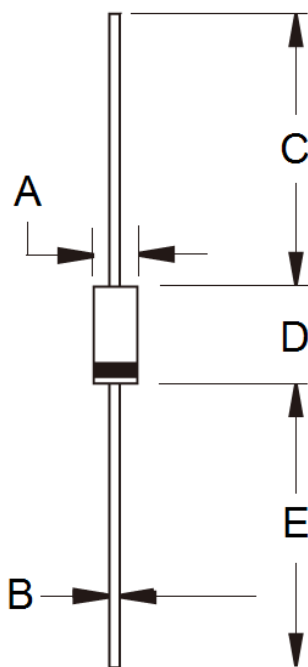

DIM.	Unit(mm)		Unit(inch)	
	Min	Max	Min	Max
A	2.60	3.60	0.102	0.142
B	0.70	0.90	0.028	0.035
C	25.40	-	1.000	-
D	5.80	7.60	0.228	0.299
E	25.40	-	1.000	-

**Marking Diagram**

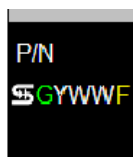

- P/N = Specific Device Code
- G = Green Compound
- YWW = Date Code
- F = Factory Code