

## FEATURES

- Schottky diode detector with linearization
- Broadband 50  $\Omega$  input impedance
- Accurate response from 0.5 GHz to 43.5 GHz with minimal slope variation
- Input range of  $-30$  dBm to  $+15$  dBm, referred to 50  $\Omega$
- Excellent temperature stability
- 2.1 V/V<sub>PEAK</sub> (output voltage per input peak voltage) slope at 10 GHz
- Fast envelope bandwidth: 40 MHz
- Fast output rise time: 4 ns
- Low power consumption: 1.6 mA at 5.0 V
- 2 mm  $\times$  2 mm, 6-lead LFCSP package

## APPLICATIONS

- Microwave point to point links
- Microwave instrumentation
- Radar-based measurement systems

## GENERAL DESCRIPTION

The **ADL6010** is a versatile, broadband envelope detector covering the microwave spectrum. It provides state-of-the-art accuracy with very low power consumption (8 mW) in a simple, easy to use 6-lead format. The output is a baseband voltage proportional to the instantaneous amplitude of the radio frequency (RF) input signal. It exhibits minimal slope variation of the RF input to envelope output transfer function from 0.5 GHz to 43.5 GHz.

The detector cell uses a proprietary eight Schottky diode array followed by a novel linearizer circuit that creates a linear voltmeter with an overall scaling factor (or transfer gain) of nominally  $\times 2.2$  relative to the voltage amplitude of the input.

Although the **ADL6010** is not inherently a power responding device, it remains convenient to specify the input in this way. Thus, the permissible input power, relative to a 50  $\Omega$  source input impedance, ranges from  $-30$  dBm to  $+15$  dBm. The corresponding input voltage amplitudes of 11.2 mV to 1.8 V generate quasi-dc outputs from about 25 mV to 4 V above common (COMM).

## FUNCTIONAL BLOCK DIAGRAM

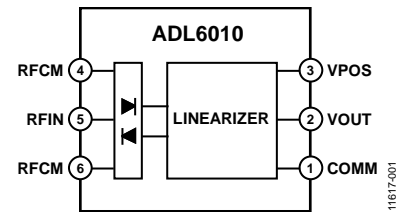

Figure 1.

A subtle aspect of the balanced detector topology is that no even-order distortion, caused by nonlinear source loading, occurs at the input. This is an important benefit in applications where a low ratio coupler is used to extract a signal sample and is a significant improvement over traditional diode detectors.

The power equivalent of a fluctuating RF input amplitude can be extracted by the addition of an rms-to-dc converter IC. Alternatively, the baseband output can be applied to a suitably fast analog-to-digital converter (ADC) and the rms value (and other signal metrics, such as peak to average ratio) calculated in the digital domain.

The output response accuracy is insensitive to variation in the supply voltage, which can range from 4.75 V to 5.25 V. The ultralow power dissipation contributes to its long-term stability.

The **ADL6010A** is specified for operation from  $-40^{\circ}\text{C}$  to  $+85^{\circ}\text{C}$ , and the **ADL6010S** is specified for operation from  $-55^{\circ}\text{C}$  to  $+125^{\circ}\text{C}$ . Both are available in a 6-lead, 2 mm  $\times$  2 mm LFCSP package.

**TABLE OF CONTENTS**

Features .....	1	Theory of Operation .....	16
Applications.....	1	Basic Connections.....	17
Functional Block Diagram .....	1	PCB Layout Recommendations .....	17
General Description .....	1	System Calibration and Error Calculation.....	17
Revision History .....	2	Effect of a Capacitive Load on Rise Time and Fall Time .....	19
Specifications.....	3	Evaluation Board .....	20
Absolute Maximum Ratings.....	7	Evaluation Board Assembly Drawings .....	21
ESD Caution.....	7	Outline Dimensions .....	22
Pin Configuration and Function Descriptions.....	8	Ordering Guide .....	22
Typical Performance Characteristics .....	9		
Measurement Setups .....	15		

**REVISION HISTORY**

**9/14—Rev. 0 to Rev. A**

- Deleted Figure 3 and Figure 6; Renumbered Sequentially..... 9
- Deleted Figure 39 and Changes to Theory of Operation Section .. 16

**7/14—Revision 0: Initial Version**

## SPECIFICATIONS

VPOS = 5.0 V,  $T_A = 25^\circ\text{C}$ ,  $50\ \Omega$  source input impedance, single-ended input drive, unless otherwise stated.

Table 1.

Parameter	Test Conditions/Comments	Min	Typ <sup>1</sup>	Max	Unit
<b>RF INPUT INTERFACE</b>					
Operating Frequency	RFIN pin	0.5		43.5	GHz
Nominal Input Impedance	Single-ended input drive, see the Theory of Operation section		50		$\Omega$
<b>FREQUENCY = 500 MHz</b>					
Detection Range	Input RFIN to output VOUT				
±1 dB Error	Continuous wave (CW) input		44		dB
Maximum Input Level, ±1 dB	Three point calibration at -26 dBm, -14 dBm, and +5 dBm		16		dBm
Minimum Input Level, ±1 dB	Three point calibration at -26 dBm, -14 dBm, and +5 dBm		-28		dBm
Deviation vs. Temperature	Deviation from output at 25°C				
	-40°C < $T_A$ < +85°C, input power ( $P_{IN}$ ) = +10 dBm		+0.2/-0.1		dB
	-55°C < $T_A$ < +125°C, $P_{IN}$ = +10 dBm		+0.3/-0.2		dB
	-40°C < $T_A$ < +85°C, $P_{IN}$ = -10 dBm		+0.7/-0.6		dB
	-55°C < $T_A$ < +125°C, $P_{IN}$ = -10 dBm		+0.9/-1.2		dB
Slope	Calibration at -14 dBm and +5 dBm		2.2		V/V <sub>PEAK</sub>
Intercept	Calibration at -14 dBm and +5 dBm		0.3		V
Output Voltage					
	$P_{IN}$ = +10 dBm		2.2		V
	$P_{IN}$ = -10 dBm		0.19		V
<b>FREQUENCY = 1 GHz</b>					
Detection Range	Input RFIN to output VOUT				
±1 dB Error	CW input		45		dB
Maximum Input Level, ±1 dB	Three point calibration at -25 dBm, -10 dBm, and +8 dBm		15		dBm
Minimum Input Level, ±1 dB	Three point calibration at -25 dBm, -10 dBm, and +8 dBm		-30		dBm
Deviation vs. Temperature	Deviation from output at 25°C				
	-40°C < $T_A$ < +85°C, $P_{IN}$ = +10 dBm		+0.1/-0.1		dB
	-55°C < $T_A$ < +125°C, $P_{IN}$ = +10 dBm		+0.2/-0.2		dB
	-55°C < $T_A$ < +125°C, $P_{IN}$ = -10 dBm		+0.3/-0.3		dB
	-40°C < $T_A$ < +85°C, $P_{IN}$ = -10 dBm		+0.4/-0.6		dB
Slope	Calibration at -10 dBm and +8 dBm		2.2		V/V <sub>PEAK</sub>
Intercept	Calibration at -10 dBm and +8 dBm		0.5		V
Output Voltage					
	$P_{IN}$ = +10 dBm		2.25		V
	$P_{IN}$ = -10 dBm		0.22		V
<b>FREQUENCY = 5 GHz</b>					
Detection Range	Input RFIN to output VOUT				
±1 dB Error	CW input		46		dB
Maximum Input Level, ±1 dB	Three point calibration at -25 dBm, -10 dBm, and +8 dBm		16		dBm
Minimum Input Level, ±1 dB	Three point calibration at -25 dBm, -10 dBm, and +8 dBm		-30		dBm
Deviation vs. Temperature	Deviation from output at 25°C				
	-40°C < $T_A$ < +85°C, $P_{IN}$ = +10 dBm		+0.2/-0.1		dB
	-55°C < $T_A$ < +125°C, $P_{IN}$ = +10 dBm		+0.3/-0.2		dB
	-40°C < $T_A$ < +85°C, $P_{IN}$ = -10 dBm		+0.2/-0.2		dB
	-55°C < $T_A$ < +125°C, $P_{IN}$ = -10 dBm		+0.3/-0.4		dB
Slope	Calibration at -10 dBm and +8 dBm		2.1		V/V <sub>PEAK</sub>
Intercept	Calibration at -10 dBm and +8 dBm		0.5		V
Output Voltage					
	$P_{IN}$ = +10 dBm		2.2		V
	$P_{IN}$ = -10 dBm		0.22		V

Parameter	Test Conditions/Comments	Min	Typ <sup>1</sup>	Max	Unit
FREQUENCY = 10 GHz					
Detection Range	Input RFIN to output VOUT				
±1 dB Error	CW input		46		dB
Maximum Input Level, ±1 dB	Three point calibration at –28 dBm, –10 dBm, and +10 dBm		16		dBm
Minimum Input Level, ±1 dB	Three point calibration at –28 dBm, –10 dBm, and +10 dBm		–30		dBm
Deviation vs. Temperature	Deviation from output at 25°C				
	–40°C < T <sub>A</sub> < +85°C, P <sub>IN</sub> = 10 dBm		+0.2/–0.1		dB
	–55°C < T <sub>A</sub> < +125°C, P <sub>IN</sub> = 10 dBm		+0.4/–0.2		dB
	–40°C < T <sub>A</sub> < +85°C, P <sub>IN</sub> = –10 dBm		+0.2/–0.2		dB
	–55°C < T <sub>A</sub> < +125°C, P <sub>IN</sub> = –10 dBm		+0.4/–0.4		dB
Slope	Calibration at –10 dBm and +10 dBm		2.1		V/V <sub>PEAK</sub>
Intercept	Calibration at –10 dBm and +10 dBm		0.6		V
Output Voltage					
	P <sub>IN</sub> = +10 dBm		2.1		V
	P <sub>IN</sub> = –10 dBm		0.22		V
FREQUENCY = 15 GHz					
Detection Range	Input RFIN to output VOUT				
±1 dB Error	CW input		47		dB
Maximum Input Level, ±1 dB	Three point calibration at –28 dBm, –10 dBm, and +10 dBm		16		dBm
Minimum Input Level, ±1 dB	Three point calibration at –28 dBm, –10 dBm, and +10 dBm		–30		dBm
Deviation vs. Temperature	Deviation from output at 25°C				
	–40°C < T <sub>A</sub> < +85°C, P <sub>IN</sub> = +10 dBm		+0.2/–0.2		dB
	–55°C < T <sub>A</sub> < +125°C, P <sub>IN</sub> = +10 dBm		+0.3/–0.3		dB
	–40°C < T <sub>A</sub> < +85°C, P <sub>IN</sub> = –10 dBm		+0.2/–0.3		dB
	–55°C < T <sub>A</sub> < +125°C, P <sub>IN</sub> = –10 dBm		+0.3/–0.6		dB
Slope	Calibration at –10 dBm and +10 dBm		2.1		V/V <sub>PEAK</sub>
Intercept	Calibration at –10 dBm and +10 dBm		0.6		V
Output Voltage					
	P <sub>IN</sub> = +10 dBm		2.1		V
	P <sub>IN</sub> = –10 dBm		0.22		V
FREQUENCY = 20 GHz					
Detection Range	Input RFIN to output VOUT				
±1 dB Error	CW input		46		dB
Maximum Input Level, ±1 dB	Three point calibration at –28 dBm, –10 dBm, and +8 dBm		15		dBm
Minimum Input Level, ±1 dB	Three point calibration at –28 dBm, –10 dBm, and +8 dBm		–30		dBm
Deviation vs. Temperature	Deviation from output at 25°C				
	–40°C < T <sub>A</sub> < +85°C, P <sub>IN</sub> = +10 dBm		+0.2/–0.2		dB
	–55°C < T <sub>A</sub> < +125°C, P <sub>IN</sub> = +10 dBm		+0.3/–0.4		dB
	–40°C < T <sub>A</sub> < +85°C, P <sub>IN</sub> = –10 dBm		+0.2/–0.3		dB
	–55°C < T <sub>A</sub> < +125°C, P <sub>IN</sub> = –10 dBm		+0.3/–0.6		dB
Slope	Calibration at –10 dBm and +8 dBm		2.2		V/V <sub>PEAK</sub>
Intercept	Calibration at –10 dBm and +8 dBm		0.55		V
Output Voltage					
	P <sub>IN</sub> = +10 dBm		2.3		V
	P <sub>IN</sub> = –10 dBm		0.246		V

Parameter	Test Conditions/Comments	Min	Typ <sup>1</sup>	Max	Unit
FREQUENCY = 25 GHz	Input RFIN to output VOUT				
Detection Range ±1 dB Error	CW input		46		dB
Maximum Input Level, ±1 dB	Three point calibration at –28 dBm, –10 dBm, and +8 dBm		15		dBm
Minimum Input Level, ±1 dB	Three point calibration at –28 dBm, –10 dBm, and +8 dBm		–30		dBm
Deviation vs. Temperature	Deviation from output at 25°C				
	–40°C < T <sub>A</sub> < +85°C, P <sub>IN</sub> = +10 dBm		+0.2/–0.2		dB
	–55°C < T <sub>A</sub> < +125°C, P <sub>IN</sub> = +10 dBm		+0.3/–0.4		dB
	–40°C < T <sub>A</sub> < +85°C, P <sub>IN</sub> = –10 dBm		+0.2/–0.4		dB
	–55°C < T <sub>A</sub> < +125°C, P <sub>IN</sub> = –10 dBm		+0.3/–0.7		dB
Slope	Calibration at –14 dBm and +10 dBm		2.3		V/V <sub>PEAK</sub>
Intercept	Calibration at –14 dBm and +10 dBm		0.55		V
Output Voltage					
	P <sub>IN</sub> = +10 dBm		2.36		V
	P <sub>IN</sub> = –10 dBm		0.242		V
FREQUENCY = 30 GHz	Input RFIN to output VOUT				
Detection Range ±1 dB Error	CW input		45		dB
Maximum Input Level, ±1 dB	Three point calibration at –26 dBm, 0 dBm, and +10 dBm		16		dBm
Minimum Input Level, ±1 dB	Three point calibration at –26 dBm, 0 dBm, and +10 dBm		–29		dBm
Deviation vs. Temperature	Deviation from output at 25°C				
	–40°C < T <sub>A</sub> < +85°C, P <sub>IN</sub> = +10 dBm		+0.3/–0.2		dB
	–55°C < T <sub>A</sub> < +125°C, P <sub>IN</sub> = +10 dBm		+0.4/–0.4		dB
	–40°C < T <sub>A</sub> < +85°C, P <sub>IN</sub> = –10 dBm		+0.5/–0.5		dB
	–55°C < T <sub>A</sub> < +125°C, P <sub>IN</sub> = –10 dBm		+0.6/–0.8		dB
Slope	Calibration at 0 dBm and +10 dBm		2.3		V/V <sub>PEAK</sub>
Intercept	Calibration at 0 dBm and +10 dBm		0.6		V
Output Voltage					
	P <sub>IN</sub> = +10 dBm		2.2		V
	P <sub>IN</sub> = –10 dBm		0.21		V
FREQUENCY = 35 GHz	Input RFIN to output VOUT				
Detection Range ±1 dB Error	CW input		44		dB
Maximum Input Level, ±1 dB	Three point calibration at –25 dBm, 0 dBm, and +10 dBm		15		dBm
Minimum Input Level, ±1 dB	Three point calibration at –25 dBm, 0 dBm, and +10 dBm		–29		dBm
Deviation vs. Temperature	Deviation from output at 25°C				
	–40°C < T <sub>A</sub> < +85°C, P <sub>IN</sub> = +10 dBm		+0.4/–0.4		dB
	–55°C < T <sub>A</sub> < +125°C, P <sub>IN</sub> = +10 dBm		+0.5/–0.6		dB
	–40°C < T <sub>A</sub> < +85°C, P <sub>IN</sub> = –10 dBm		+0.5/–0.5		dB
	–55°C < T <sub>A</sub> < +125°C, P <sub>IN</sub> = –10 dBm		+0.6/–1.6		dB
Slope	Calibration at 0 dBm and 10 dBm		2.4		V/V <sub>PEAK</sub>
Intercept	Calibration at 0 dBm and 10 dBm		0.6		V
Output Voltage					
	P <sub>IN</sub> = +10 dBm		2.3		V
	P <sub>IN</sub> = –10 dBm		0.198		V

Parameter	Test Conditions/Comments	Min	Typ <sup>1</sup>	Max	Unit
FREQUENCY = 40 GHz	Input RFIN to output VOUT				
Detection Range	CW input		42		dB
±1 dB Error			17		dBm
Maximum Input Level, ±1 dB	Three point calibration at –20 dBm, 0 dBm, and +10 dBm		–25		dBm
Minimum Input Level, ±1 dB	Three point calibration at –20 dBm, 0 dBm, and +10 dBm				
Deviation vs. Temperature	Deviation from output at 25°C				
	–40°C < T <sub>A</sub> < +85°C, P <sub>IN</sub> = +10 dBm		+0.2/–0.2		dB
	–55°C < T <sub>A</sub> < +125°C, P <sub>IN</sub> = +10 dBm		+0.3/–0.3		dB
	–40°C < T <sub>A</sub> < +85°C, P <sub>IN</sub> = –10 dBm		+0.5/–0.5		dB
	–55°C < T <sub>A</sub> < +125°C, P <sub>IN</sub> = –10 dBm		+0.6/–0.9		dB
Slope	Calibration at 0 dBm and 10 dBm		1.7		V/V <sub>PEAK</sub>
Intercept	Calibration at 0 dBm and 10 dBm		0.4		V
Output Voltage					
	P <sub>IN</sub> = +10 dBm		1.64		V
	P <sub>IN</sub> = –10 dBm		0.135		V
FREQUENCY = 43.5 GHz	Input RFIN to output VOUT				
Detection Range	CW input		41		dB
±1 dB Error			17		dBm
Maximum Input Level, ±1 dB	Three point calibration at –20 dBm, 0 dBm, and +10 dBm		–24		dBm
Minimum Input Level, ±1 dB	Three point calibration at –20 dBm, 0 dBm, and +10 dBm				
Deviation vs. Temperature	Deviation from output at 25°C				
	–40°C < T <sub>A</sub> < +85°C, P <sub>IN</sub> = +10 dBm		+0.6/–0.4		dB
	–55°C < T <sub>A</sub> < +125°C, P <sub>IN</sub> = +10 dBm		+0.7/–0.7		dB
	–40°C < T <sub>A</sub> < +85°C, P <sub>IN</sub> = –10 dBm		+0.7/–0.5		dB
	–55°C < T <sub>A</sub> < +125°C, P <sub>IN</sub> = –10 dBm		+0.8/–1.1		dB
Slope	Calibration at 0 dBm and 10 dBm		1.6		V/V <sub>PEAK</sub>
Intercept	Calibration at 0 dBm and 10 dBm		0.35		V
Output Voltage					
	P <sub>IN</sub> = +10 dBm		1.46		V
	P <sub>IN</sub> = –10 dBm		0.118		V
OUTPUT INTERFACE	Pin VOUT				
DC Output Resistance			<5		Ω
Output Offset	P <sub>IN</sub> = off		4		mV
Maximum Output Voltage	T <sub>A</sub> = 25°C, VPOS = 5.0 V, P <sub>IN</sub> = 19 dBm		4.3		V
Available Output Current	Sourcing/sinking		5/0.3		mA
Rise Time	P <sub>IN</sub> = off to 0 dBm, 10% to 90%, C <sub>LOAD</sub> = 10 pF, R <sub>SERIES</sub> = 100 Ω		4		ns
Fall Time	P <sub>IN</sub> = off to 0 dBm, 10% to 90%, C <sub>LOAD</sub> = 10 pF, R <sub>SERIES</sub> = 100 Ω		50		ns
Envelope Bandwidth	3 dB bandwidth		40		MHz
POWER SUPPLIES	Pin VPOS				
Supply Voltage		4.75	5.0	5.25	V
Quiescent Current	T <sub>A</sub> = 25°C, no signal at RFIN, VPOS = 5.0 V		1.6		mA
	–40°C < T <sub>A</sub> < +85°C		2.0		mA
	–55°C < T <sub>A</sub> < +125°C		2.2		mA

<sup>1</sup> Slashes in the typical (typ) column indicate a range. For example, –0.2/+0.1 means –0.2 to +0.1.

## ABSOLUTE MAXIMUM RATINGS

Table 2.

Parameter	Rating
Supply Voltage, VPOS	5.5 V
Input RF Power <sup>1</sup>	20 dBm
Equivalent Voltage, Sine Wave Input	3.16 V
Internal Power Dissipation	20 mW
$\theta_{JC}$ <sup>2</sup>	16.4°C/W
$\theta_{JA}$ <sup>2</sup>	82.9°C/W
$\Psi_{JT}$ <sup>2</sup>	0.6°C/W
$\Psi_{JB}$ <sup>2</sup>	49.3°C/W
Maximum Junction Temperature	150°C
Operating Temperature Range	
ADL6010ACPZN-R7	-40°C < T <sub>A</sub> < +85°C
ADL6010SCPZN-R7	-55°C < T <sub>A</sub> < +125°C
Storage Temperature Range	-65°C to +150°C
Lead Temperature (Soldering 60 sec)	300°C

<sup>1</sup> Driven from a 50  $\Omega$  source.

<sup>2</sup> No airflow when the exposed pad soldered to a 4-layer JEDEC board.

Stresses at or above those listed under Absolute Maximum Ratings may cause permanent damage to the product. This is a stress rating only; functional operation of the product at these or any other conditions above those indicated in the operational section of this specification is not implied. Operation beyond the maximum operating conditions for extended periods may affect product reliability.

### ESD CAUTION



**ESD (electrostatic discharge) sensitive device.** Charged devices and circuit boards can discharge without detection. Although this product features patented or proprietary protection circuitry, damage may occur on devices subjected to high energy ESD. Therefore, proper ESD precautions should be taken to avoid performance degradation or loss of functionality.

## PIN CONFIGURATION AND FUNCTION DESCRIPTIONS

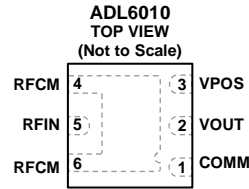

### NOTES

1. EXPOSED PAD. THE EXPOSED PAD (EPAD) ON THE UNDERSIDE OF THE DEVICE IS ALSO INTERNALLY CONNECTED TO GROUND AND REQUIRES GOOD THERMAL AND ELECTRICAL CONNECTION TO THE GROUND OF THE PRINTED CIRCUIT BOARD (PCB). CONNECT ALL GROUND PINS TO A LOW IMPEDANCE GROUND PLANE TOGETHER WITH THE EPAD.

11817-002

Figure 2. Pin Configuration

Table 3. Pin Function Descriptions

Pin No.	Mnemonic	Description
1	COMM	Device Ground. Connect COMM to the system ground using a low impedance ground plane together with the exposed pad (EPAD).
2	VOUT	Output Voltage. The output from the VOUT pin is proportional to the envelope value at the RFIN pin.
3	VPOS	Supply Voltage. The operational range is from 4.75 V to 5.25 V. Decouple the power supply using the suggested capacitor values of 100 pF and 0.1 $\mu$ F and locate these capacitors as close as possible to the VPOS pin.
4, 6	RFCM	Device Grounds. Connect the RFCM pins to the system ground using a low impedance ground plane together with the exposed pad (EPAD).
5	RFIN EPAD	Signal Input. The RFIN pin is ac-coupled and has an RF input impedance of approximately 50 $\Omega$ . Exposed Pad. The exposed pad (EPAD) on the underside of the device is also internally connected to ground and requires good thermal and electrical connection to the ground of the printed circuit board (PCB). Connect all ground pins to a low impedance ground plane together with the EPAD.



### TYPICAL PERFORMANCE CHARACTERISTICS

V<sub>POS</sub> = 5.0 V, C<sub>LOAD</sub> = open, T<sub>A</sub> = 25°C, unless otherwise specified. Error referred to slope and intercept at indicated calibration points. Single-ended input drive, input RF signal is a continuous sine wave, unless otherwise noted.

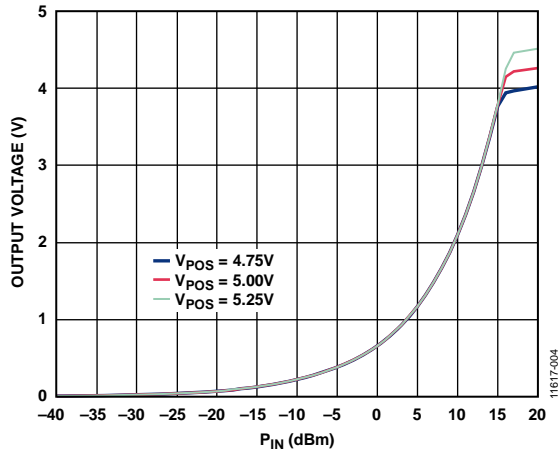

Figure 3. Output Voltage (V<sub>OUT</sub>) vs. RF Input Power (P<sub>IN</sub>) for Various Supply Voltages

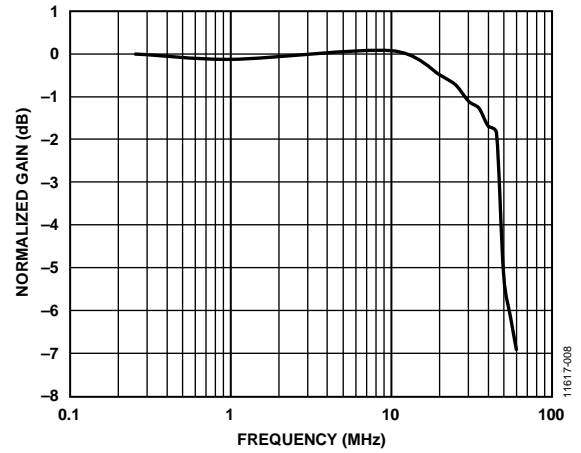

Figure 6. Envelope Bandwidth of V<sub>OUT</sub> vs. Frequency at P<sub>IN</sub> = -10 dBm and Modulation Depth = 10% (See Figure 36 in the Measurement Setups Section)

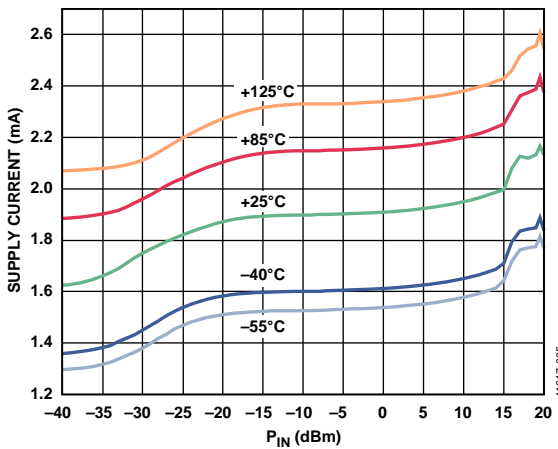

Figure 4. Supply Current vs. RF Input Power (P<sub>IN</sub>) for Various Temperatures

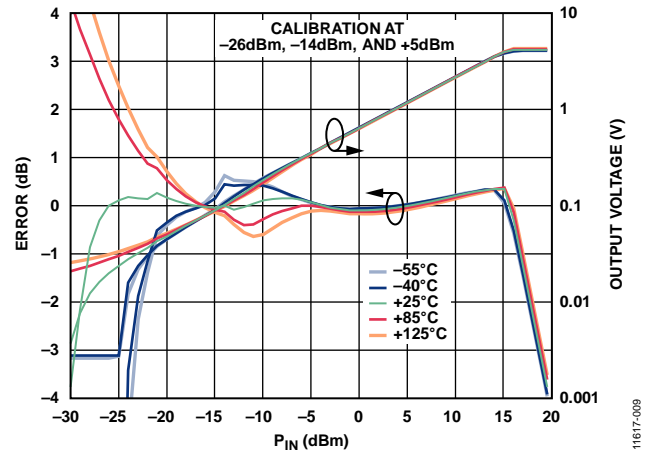

Figure 7. Conformance Error and Output Voltage (V<sub>OUT</sub>) vs. RF Input Power (P<sub>IN</sub>) for Various Temperatures at 0.5 GHz

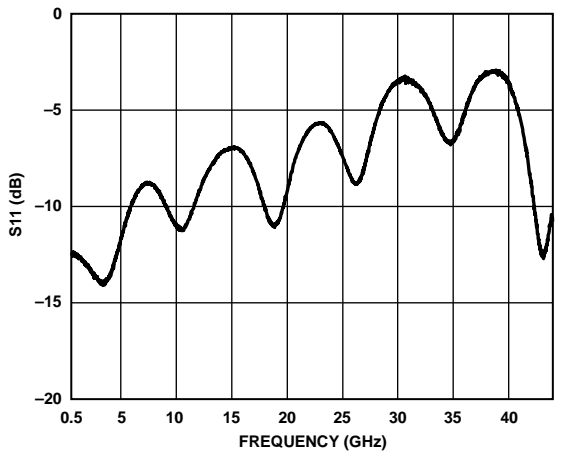

Figure 5. Input Return Loss (S<sub>11</sub>) vs. Input Frequency with Input Connector and PCB Trace Embedded

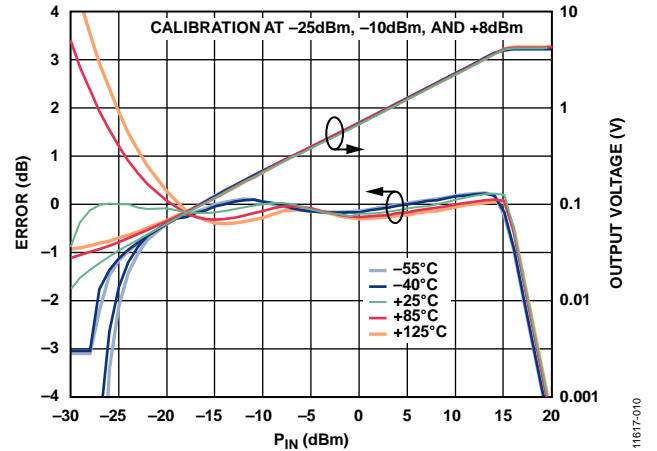

Figure 8. Conformance Error and Output Voltage (V<sub>OUT</sub>) vs. RF Input Power (P<sub>IN</sub>) for Various Temperatures at 1 GHz

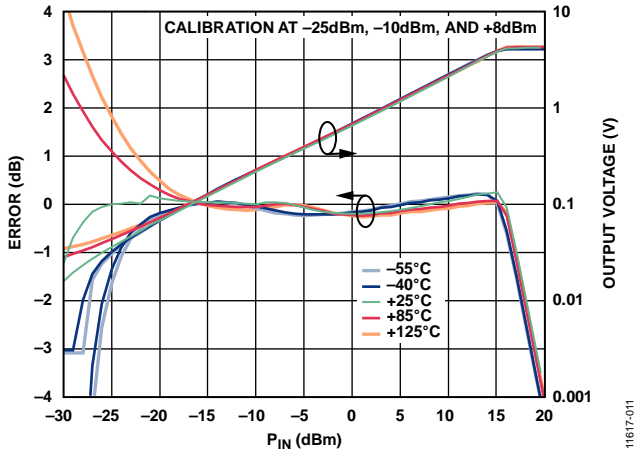

Figure 9. Conformance Error and Output Voltage ( $V_{out}$ ) vs. RF Input Power ( $P_{in}$ ) for Various Temperatures at 5 GHz

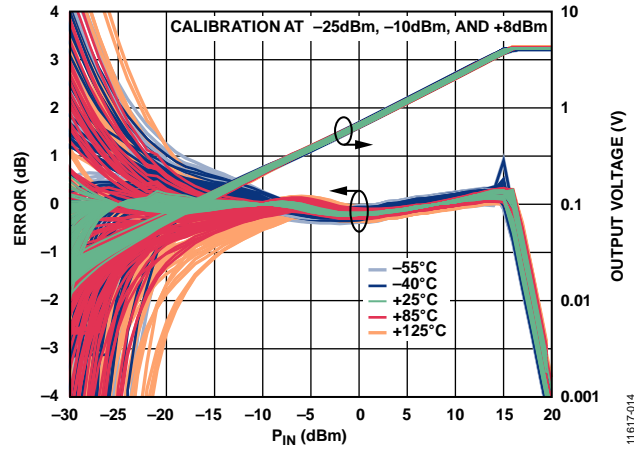

Figure 12. Distribution of Conformance Error with Respect to Output Voltage ( $V_{out}$ ) at 25°C vs. RF Input Power ( $P_{in}$ ) for Various Temperatures at 5 GHz

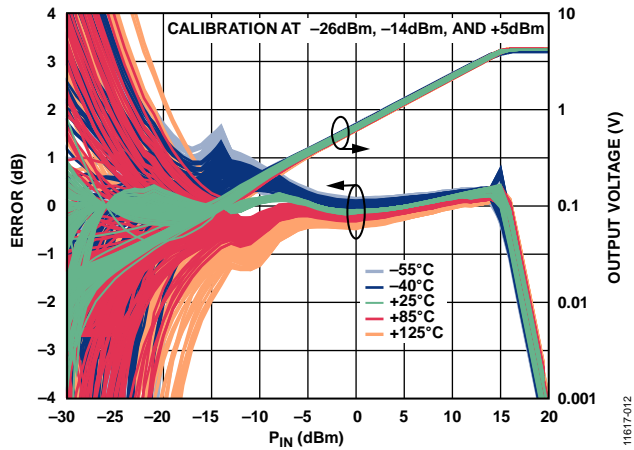

Figure 10. Distribution of Conformance Error with Respect to Output Voltage ( $V_{out}$ ) at 25°C vs. RF Input Power ( $P_{in}$ ) for Various Temperatures at 0.5 GHz

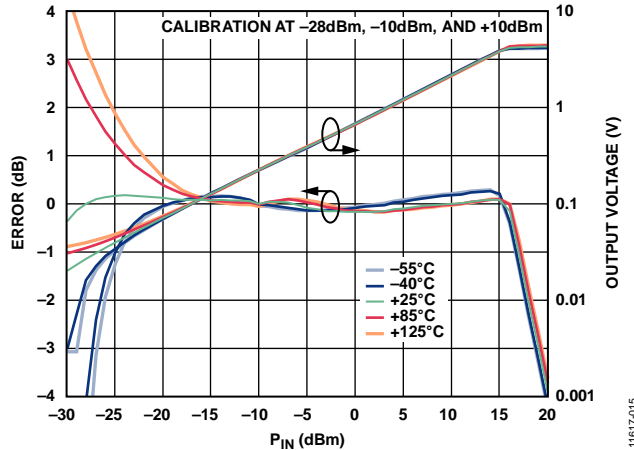

Figure 13. Conformance Error and Output Voltage ( $V_{out}$ ) vs. RF Input Power ( $P_{in}$ ) for Various Temperatures at 10 GHz

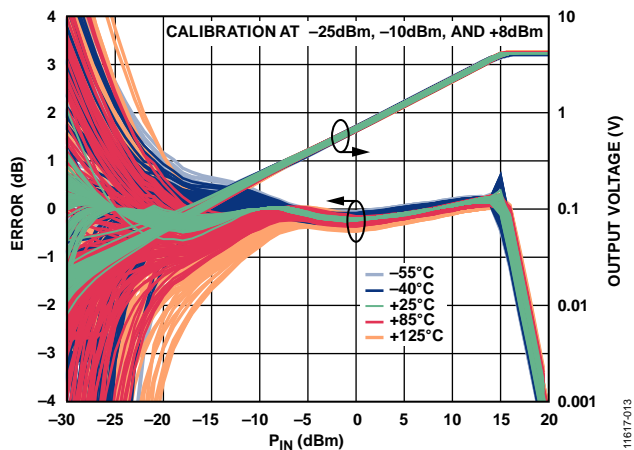

Figure 11. Distribution of Conformance Error with Respect to Output Voltage ( $V_{out}$ ) at 25°C vs. RF Input Power ( $P_{in}$ ) for Various Temperatures at 1 GHz

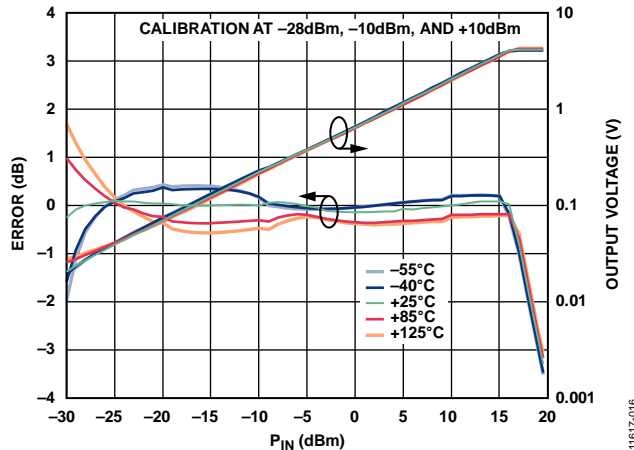

Figure 14. Conformance Error and Output Voltage ( $V_{out}$ ) vs. RF Input Power ( $P_{in}$ ) for Various Temperatures at 15 GHz

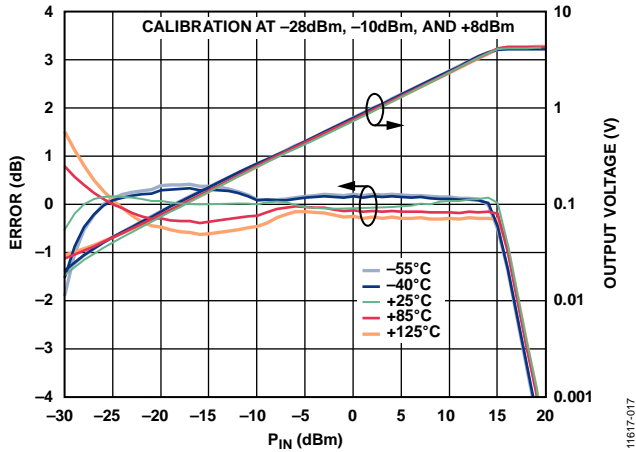

Figure 15. Conformance Error and Output Voltage ( $V_{OUT}$ ) vs. RF Input Power ( $P_{IN}$ ) for Various Temperatures at 20 GHz

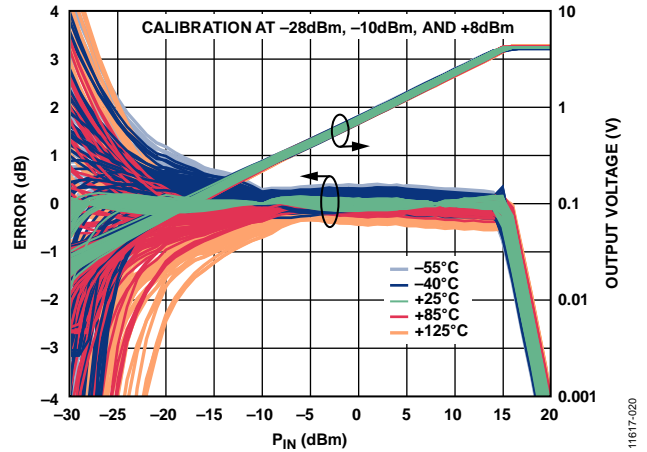

Figure 18. Distribution of Conformance Error with Respect to Output Voltage ( $V_{OUT}$ ) at 25°C vs. RF Input Power ( $P_{IN}$ ) for Various Temperatures at 20 GHz

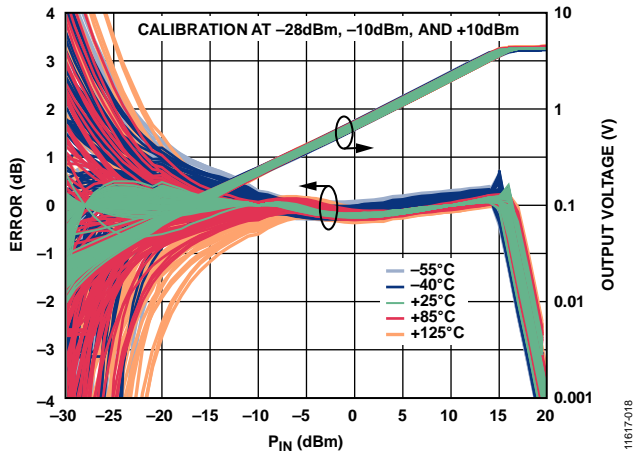

Figure 16. Distribution of Conformance Error with Respect to Output Voltage ( $V_{OUT}$ ) at 25°C vs. RF Input Power ( $P_{IN}$ ) for Various Temperatures at 10 GHz

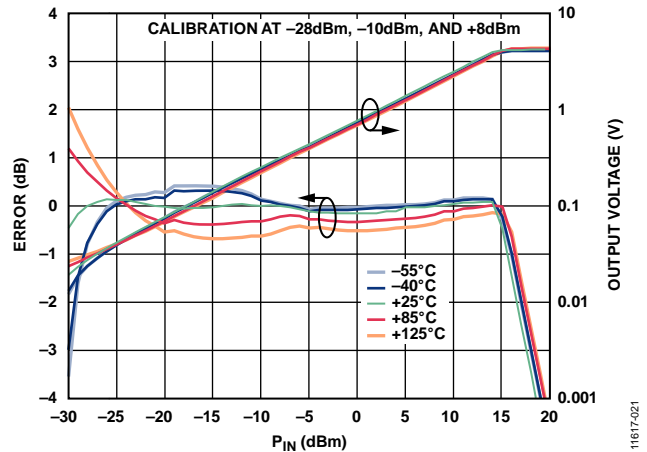

Figure 19. Conformance Error and Output Voltage ( $V_{OUT}$ ) vs. RF Input Power ( $P_{IN}$ ) for Various Temperatures at 25 GHz

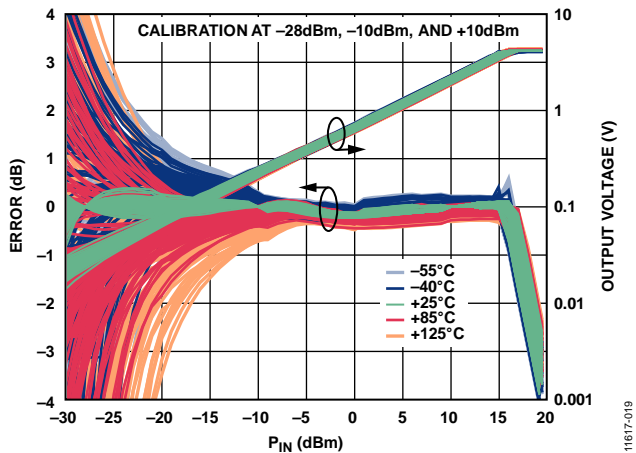

Figure 17. Distribution of Conformance Error with Respect to Output Voltage ( $V_{OUT}$ ) at 25°C vs. RF Input Power ( $P_{IN}$ ) for Various Temperatures at 15 GHz

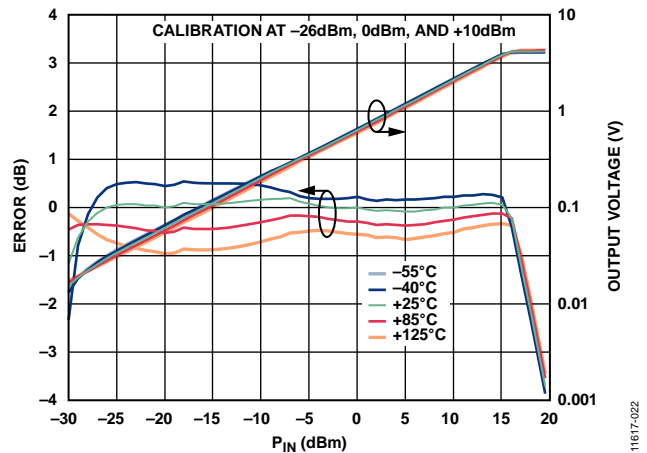

Figure 20. Conformance Error and Output Voltage ( $V_{OUT}$ ) vs. RF Input Power ( $P_{IN}$ ) for Various Temperatures at 30 GHz

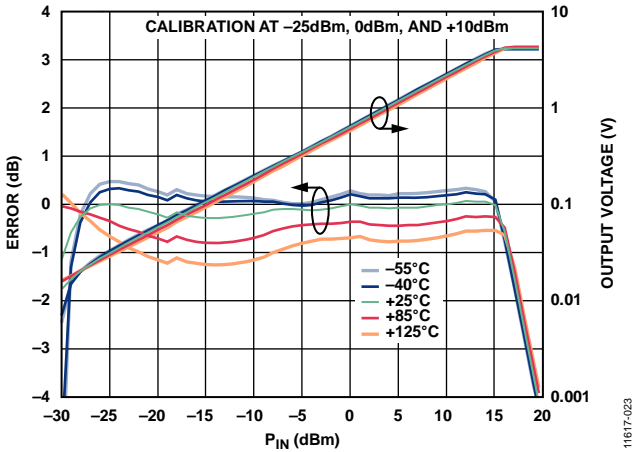

Figure 21. Conformance Error and Output Voltage ( $V_{OUT}$ ) vs. RF Input Power ( $P_{IN}$ ) for Various Temperatures at 35 GHz

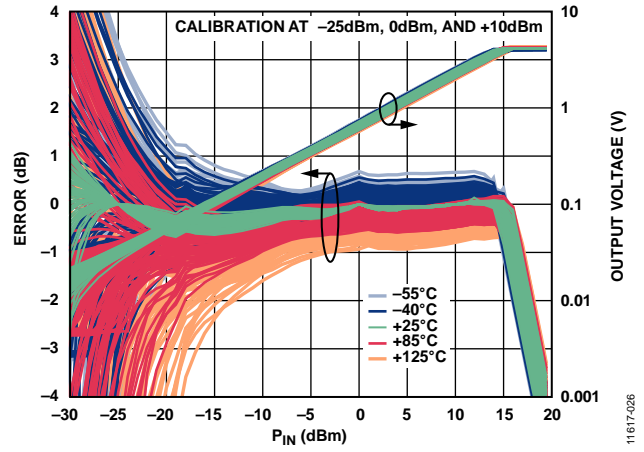

Figure 24. Distribution of Conformance Error with Respect to Output Voltage ( $V_{OUT}$ ) at 25°C vs. RF Input Power ( $P_{IN}$ ) for Various Temperatures at 35 GHz

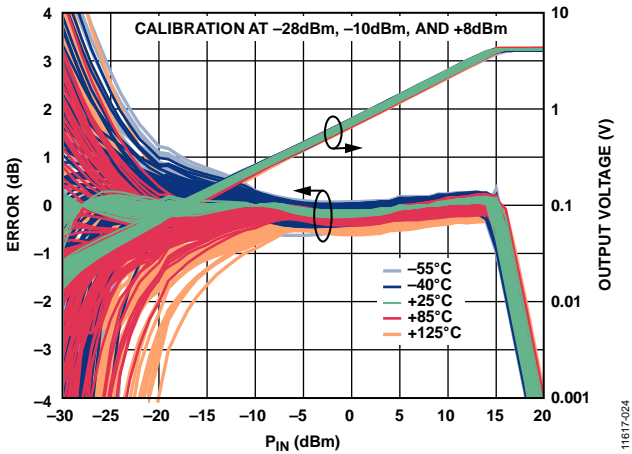

Figure 22. Distribution of Conformance Error with Respect to Output Voltage ( $V_{OUT}$ ) at 25°C vs. RF Input Power ( $P_{IN}$ ) for Various Temperatures at 25 GHz

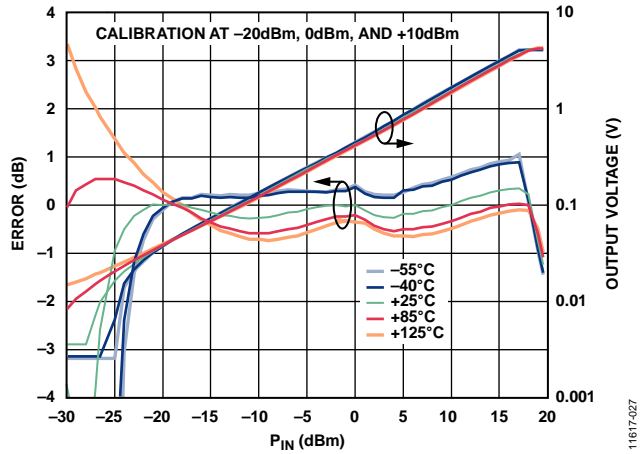

Figure 25. Conformance Error and Output Voltage ( $V_{OUT}$ ) vs. RF Input Power ( $P_{IN}$ ) for Various Temperatures at 40 GHz

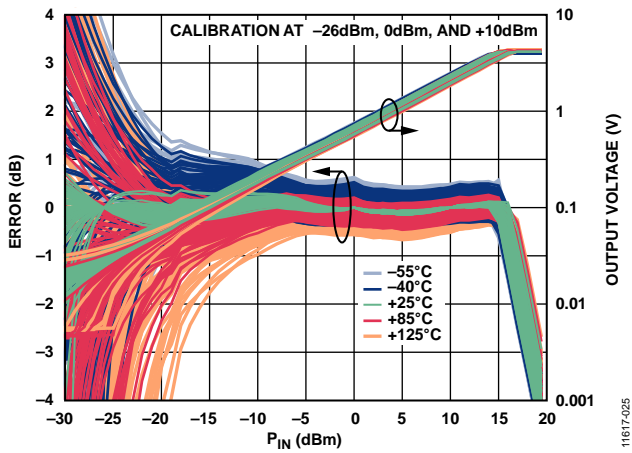

Figure 23. Distribution of Conformance Error with Respect to Output Voltage ( $V_{OUT}$ ) at 25°C vs. RF Input Power ( $P_{IN}$ ) for Various Temperatures at 30 GHz

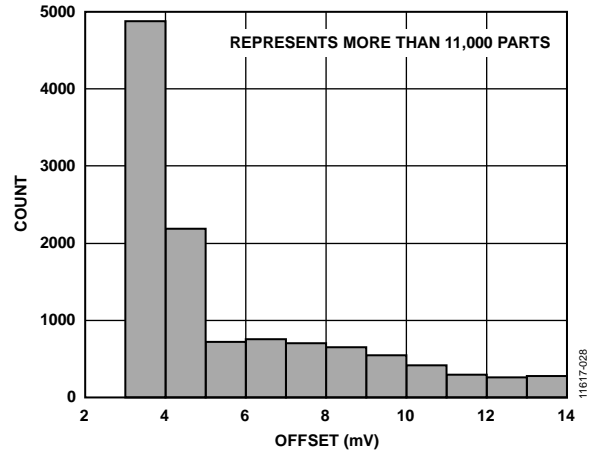

Figure 26. Distribution of  $V_{OUT}$  Offset with No Applied  $P_{IN}$  at 25°C

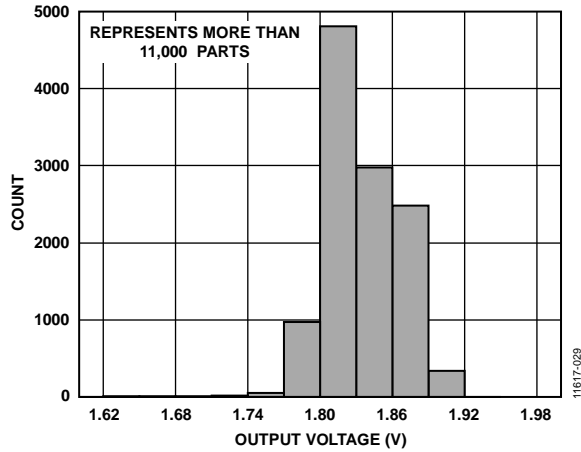

Figure 27. Output Voltage ( $V_{OUT}$ ) Distribution,  $P_{IN} = 9$  dBm at 12 GHz, 25°C

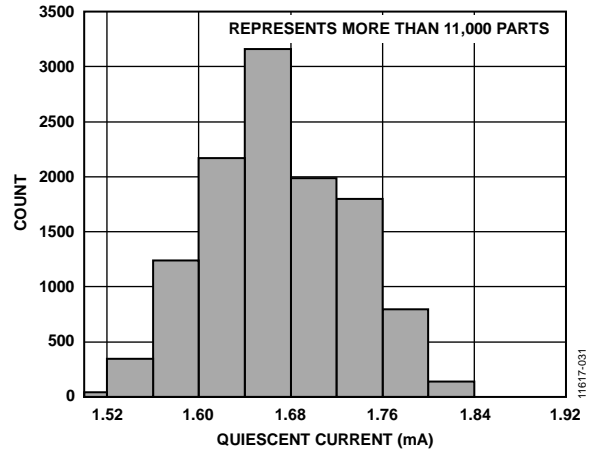

Figure 29. Distribution of Quiescent Current at 25°C

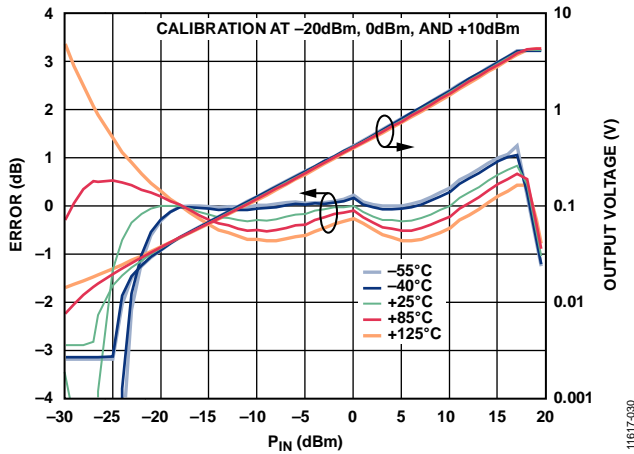

Figure 28. Conformance Error and Output Voltage ( $V_{OUT}$ ) vs. RF Input Power ( $P_{IN}$ ) for Various Temperatures at 43.5 GHz

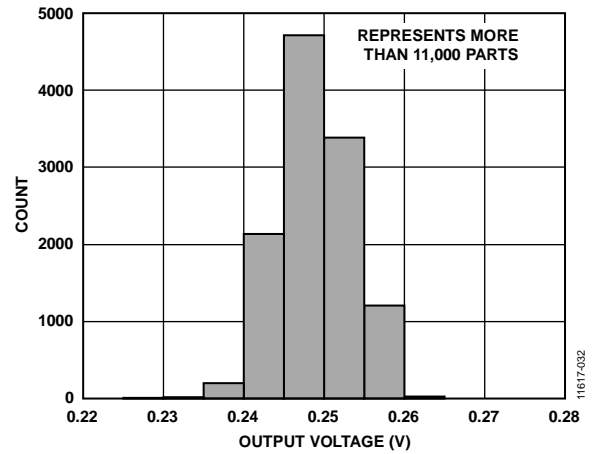

Figure 30. Output Voltage ( $V_{OUT}$ ) Distribution,  $P_{IN} = -9$  dBm at 12 GHz, 25°C

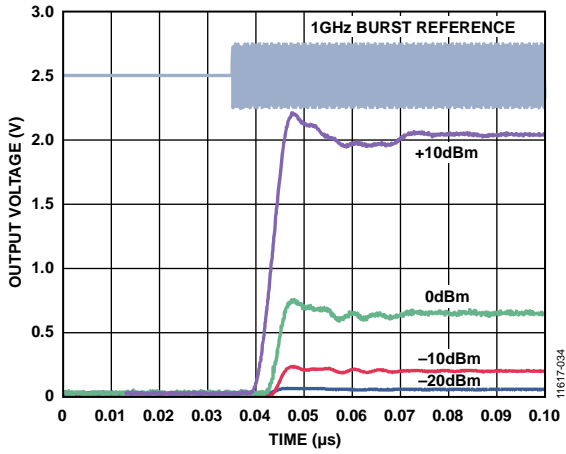

Figure 31. RF Burst Input Response, Rising Edge (see Figure 34 in the Measurement Setups Section)

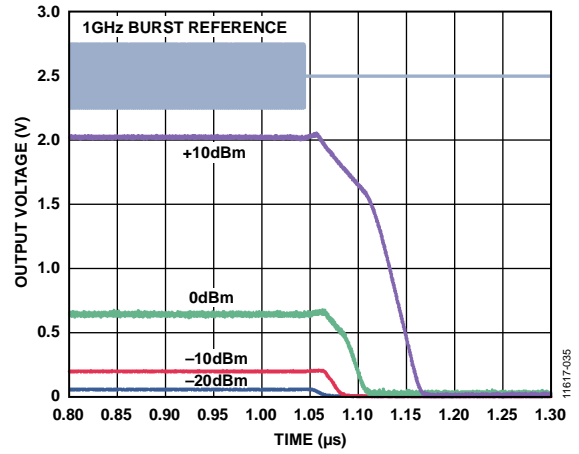

Figure 33. RF Burst Input Response, Falling Edge (see Figure 34 in the Measurement Setups Section)

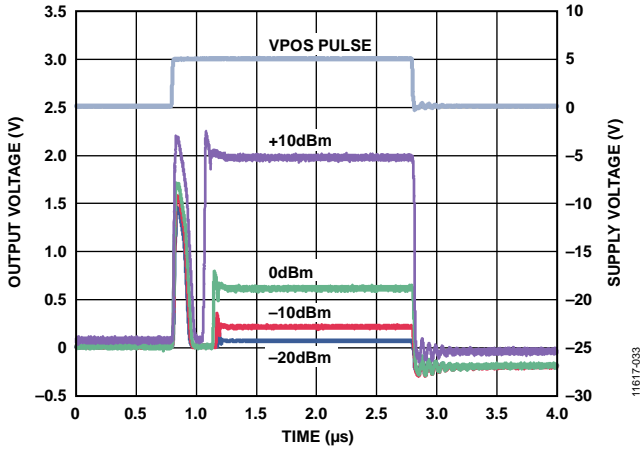

Figure 32. VPOS Turn-On Pulse Response (see Figure 35 in the Measurement Setups Section)

### MEASUREMENT SETUPS

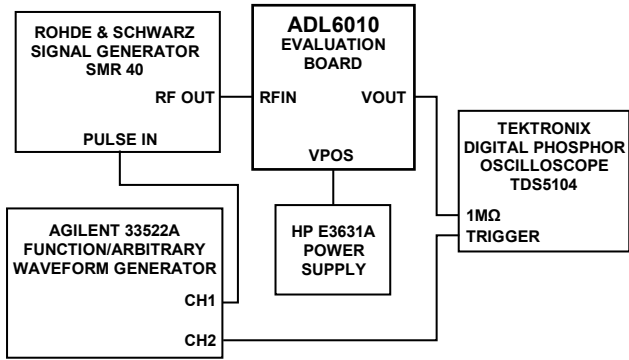

Figure 34. Hardware Configuration for Output Response to RF Burst Input Measurements

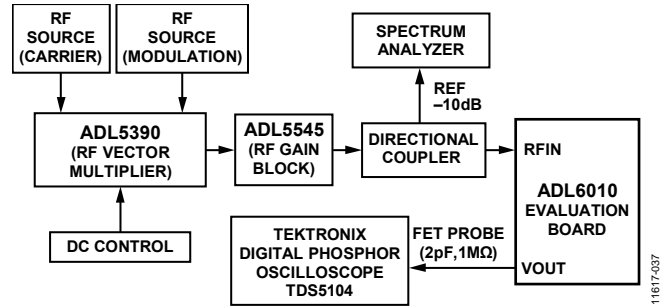

Figure 36. Hardware Configuration for Envelope Output Response Measurement

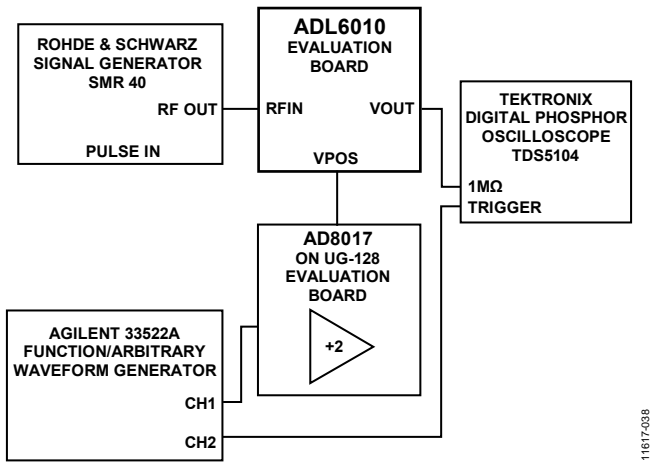

Figure 35. Hardware Configuration for Output Response to Power Supply Gating Measurements

## THEORY OF OPERATION

The [ADL6010](#) uses eight Schottky diodes in a novel two path detector topology. One path responds during the positive half cycles of the input, and the second responds during the negative half cycles of the input, thus achieving full wave rectification. This arrangement presents a constant input impedance throughout the full RF cycle, thereby preventing the reflection of even-order distortion components back toward the source, which is a well-known limitation of the widely used traditional single Schottky diode detectors.

Eight diodes are arranged on the chip in such a way as to minimize the effect of chip stresses and temperature variations. They are biased by small keep alive currents chosen in a trade-off between the inherently low sensitivity of a diode detector and the need to preserve envelope bandwidth. Thus, the corner frequency of the front-end low-pass filtering is a weak function of the input level. At low input levels, the  $-3$  dB corner frequency is at approximately 0.5 GHz. The overall envelope bandwidth is limited mainly by the subsequent linearizing and output circuitry.

At small input levels, all Schottky diode detectors exhibit an extremely weak response which approximates a square law characteristic (having zero slope at the origin). For large inputs, the response approaches a linear transfer function. In the [ADL6010](#), this nonlinearity and variations in the response are corrected using proprietary circuitry having an equally shaped but inverse amplitude function, resulting in an overall envelope response that is linear across the whole span of input levels.

The composite signal is buffered and presented at the output pin (VOUT). The transfer function relating the instantaneous RF voltage amplitude to the quasi-dc output is a scalar constant of a little over  $\times 2$ . This scalar constant is mainly determined by ratios of resistors, which are independent of temperature and process variations. Errors associated with the minuscule voltages generated by the Schottky front-end under low level conditions, and other errors in the nonlinear signal processing circuitry, are minimized by laser trimming, permitting accurate measurement of RF input voltages down to the millivolts level. An aspect of the linear in volts response is that the minimum V<sub>OUT</sub> is limited by the ability of the output stage to reach down to absolute zero (the potential on the COMM pin) when using a single positive supply.

DC voltages at the input are blocked by an on-chip capacitor. The two ground pins (RFCM) on either side of RFIN (Pin 5) form part of an RF coplanar waveguide (CPW) launch into the detector. The RFCM pins must be connected to the signal ground. Give careful attention to the design of the PCB in this area.

The envelope voltage gain of the [ADL6010](#) is nominally  $\times 2.2$  V/V<sub>PEAK</sub> from 1 GHz to 35 GHz. This factor becomes 3.2 V/V when the input signal is specified as the rms voltage of a CW carrier. For example, a steady  $-30$  dBm input generates a dc output voltage of 22.5 mV, at which level the output buffer is able to track the envelope. In fact, the sensitivity at ambient temperatures typically extends below  $-30$  dBm. However, over the specified temperature range, the measurement error tends to increase at the bottom of the specified range.

For large inputs, the voltage headroom in the signal processing stages limits the measurement range. Using a 5 V supply, the maximum signal is approximately 3.6 V p-p, corresponding to a power of 15 dBm, referenced to 50  $\Omega$ . Therefore, the [ADL6010](#) achieves a 45 dB dynamic range of high accuracy measurement. Note that, above 43.5 GHz, accuracy is limited by the package, PCB, and instrumentation. The RF input interface provides a broadband (flat) 50  $\Omega$  termination without the need for external components. Although the input return loss inevitably degrades at very high frequencies, the slope of the transfer function holds near  $2.2$  V/V<sub>PEAK</sub> up to 35 GHz, owing to the voltage responding behavior of the [ADL6010](#).



**BASIC CONNECTIONS**

The basic connections are shown in Figure 37. A dc supply of nominally 5 V is required. The bypass capacitors (C1 and C2) provide supply decoupling for the output buffer. Place these capacitors as close as possible to the VPOS pin. The exposed pad is internally connected to the IC ground and must be soldered down to a low impedance ground on the PCB. A filter capacitor (C<sub>LOAD</sub>) and series resistor (R1) may be inserted to form a low-pass filter for the output envelope. Small C<sub>LOAD</sub> values allow a quicker response to an RF burst waveform, and high C<sub>LOAD</sub> values provide signal averaging and noise reduction.

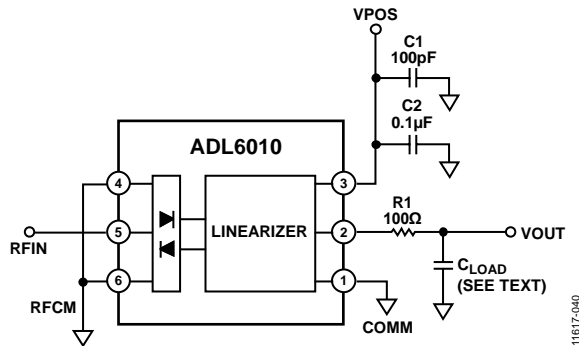

Figure 37. Basic Connections

**PCB LAYOUT RECOMMENDATIONS**

Parasitic elements of the PCB such as coupling and radiation limit accuracy at very high frequencies. Ensure faithful power transmission from the connector to the internal circuit of the ADL6010. Microstrip and CPW are popular forms of transmission lines because of their ease of fabrication and low cost. In the ADL6010 evaluation board, a grounded CPW (GCPW) minimizes radiation effects and provides the maximum bandwidth by using two rows of grounding vias on both sides of the signal trace.

Figure 38 shows the PCB layout of the ADL6010 evaluation board in detail. Minimize air gaps between the vias to ensure reliable transmission. Because a certain minimum distance between two adjacent grounding vias in a single row is needed, adding a second row of grounding vias on both sides of the GCPW is recommended. In this way, a much smaller equivalent air gap between grounding vias is achieved, and better transmission is accomplished.

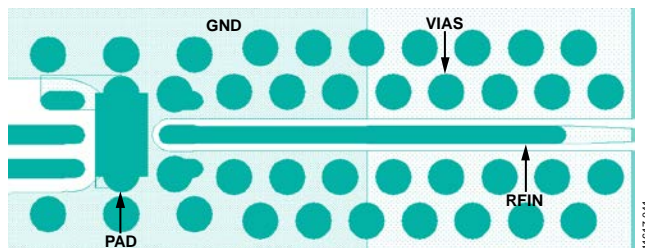

Figure 38. ADL6010 Evaluation Board

**SYSTEM CALIBRATION AND ERROR CALCULATION**

The measured transfer function of the ADL6010 at 10 GHz is shown in Figure 39. This plots both the conformance error and the output voltage vs. the input level at +25°C, +85°C, +125°C, -40°C, and -55°C. Over the input level range from -30 dBm to +15 dBm, the output voltage varies from approximately 20 mV to 4.3 V.

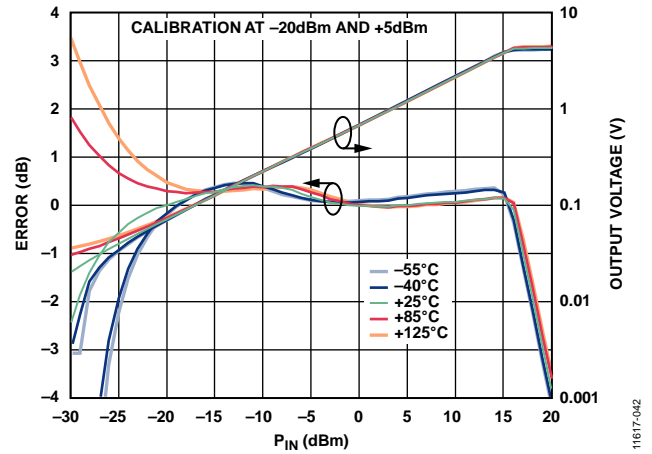

Figure 39. Conformance Error and Output Voltage vs. RF Input Power (P<sub>IN</sub>) for Various Temperatures (-55°C, -40°C, +25°C, +85°C, and +125°C) at 10 GHz Using Two Point Calibration

To achieve the highest measurement accuracy, perform calibration at the board level, as the IC scaling varies from device to device.

Calibration begins by applying two or more known signal levels, V<sub>IN1</sub> and V<sub>IN2</sub>, within the operating range of the IC, and noting the corresponding outputs, V<sub>OUT1</sub> and V<sub>OUT2</sub>. From these measurements, the slope and intercept of the scaling is extracted.

For a two point calibration, the calculations are as follows:

$$Slope = (V_{OUT2} - V_{OUT1}) / (V_{IN2} - V_{IN1})$$

$$Intercept = V_{OUT1} - (Slope \times V_{IN1})$$

where:

Each V<sub>IN</sub> is the equivalent peak input voltage to RFIN, at a 50 Ω input impedance.

Once the slope and intercept are calculated and stored, use the following simple equations to calculate the unknown input power:

$$V_{IN\_CALCULATED} = (V_{OUT(MEASURED)} - Intercept) / Slope$$

$$P_{IN\_CALCULATED} (dBm) = 10 \log_{10}(1000 \times (V_{IN\_CALCULATED} / \sqrt{2})^2 / 50)$$

The conformance error is

$$Error (dB) = P_{IN\_CALCULATED} (dBm) - P_{IN\_IDEAL} (dBm)$$

Figure 39 includes a plot of this error at -55°C, -40°C, +25°C, +85°C, and +125°C when using a two point calibration with inputs at +5 dBm and -20 dBm. The relative error at these two calibration points is equal to 0 dB by definition.

Multipoint calibration can be used to further improve accuracy and extend the dynamic range. The transfer function is now broken into segments, with each having its own slope and intercept. Thus, Figure 40 shows the error plot of the same test device with calibration input points of -28 dBm, -10 dBm, and +10 dBm. The three point, dual slope calibration results in tighter error bounds over the high end of the range and extends the lower measurement range to -30 dBm for ±1 dB error.

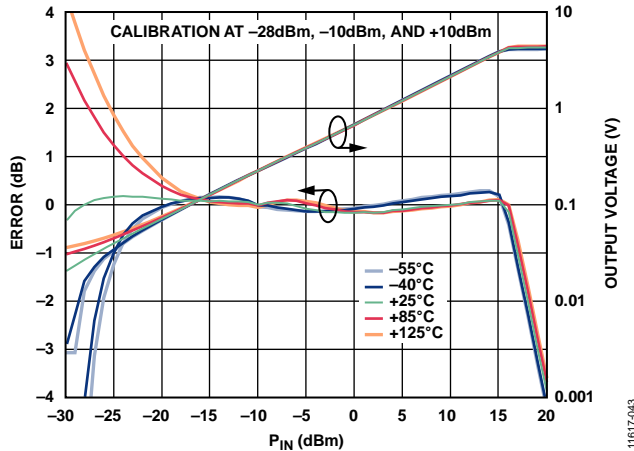

Figure 40. Conformance Error and Output Voltage vs. RF Input Power ( $P_{IN}$ ) and Temperature (-55°C, -40°C, +25°C, +85°C, +125°C) at 10 GHz Using Three Point Calibration

For the device shown in Figure 40, the change in error with temperature is very small over the upper 25 dB of the measurement range, being ±0.4 dB, and widens at lower power levels, reaching ±0.9 dB over the -10 dBm to -20 dBm segment. High volume production samples may perform better.

For comparison, the three point calibration of a second device is shown in Figure 41 using the same frequency and calibration points. This sample has greater dynamic range, and the temperature dependence of error at lower power levels is inverted relative to the first device.

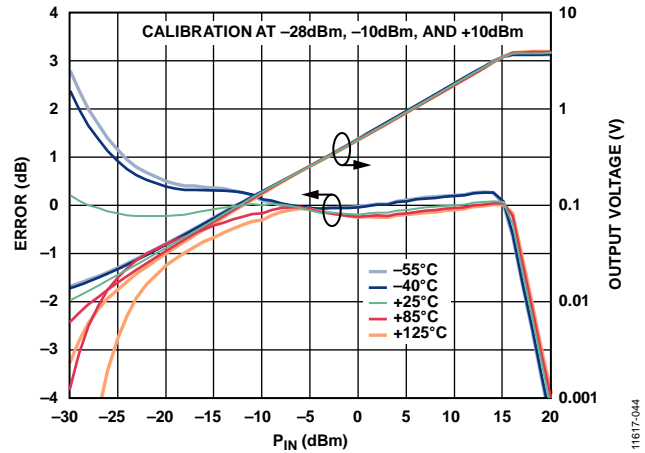

Figure 41. 10 GHz Conformance Error and Output Voltage vs. RF Input Power ( $P_{IN}$ ) for Second Device at +25°C, -40°C, -55°C, +85°C, and +125°C

Figure 42 shows the conformance error at 10 GHz for four devices at +25°C, -40°C, and +85°C using a three point calibration at input levels of -28 dBm, -10 dBm, and +10 dBm. The error plots at each temperature were calculated with respect to the slope and intercept values extracted from the 25°C line in each case. This calculation is consistent with a typical production scenario where calibration at only one temperature is used. Figure 42 illustrates the various error scenarios possible at low input levels. The dynamic range of the three point calibrated devices extends to -30 dBm for ±1.0 dB error at 25°C.

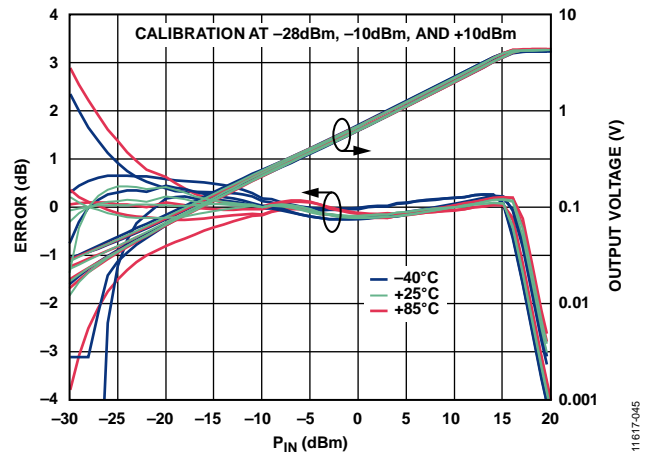

Figure 42. 10 GHz Conformance Error and Output Voltage vs. RF Input Power ( $P_{IN}$ ) at +25°C, +85°C, and -40°C for Multiple Devices

**EFFECT OF A CAPACITAVE LOAD ON RISE TIME AND FALL TIME**

The ADL6010 can measure both the instantaneous envelope power and the average power of an RF signal. When VOUT is unloaded, the output follows the envelope of the input tracking bandwidths up to 40 MHz. By adding a simple RC circuit to the basic connections circuit as shown in Figure 37, the output signal can be averaged using single pole filtering.

In applications where the response bandwidth is fairly low, place a large shunt capacitor,  $C_{LOAD}$ , directly on the VOUT pin. Figure 43 shows how rise time and fall time depend on  $C_{LOAD}$  when the ADL6010 is driven by a square wave modulated RF input at a carrier frequency of 1 GHz.

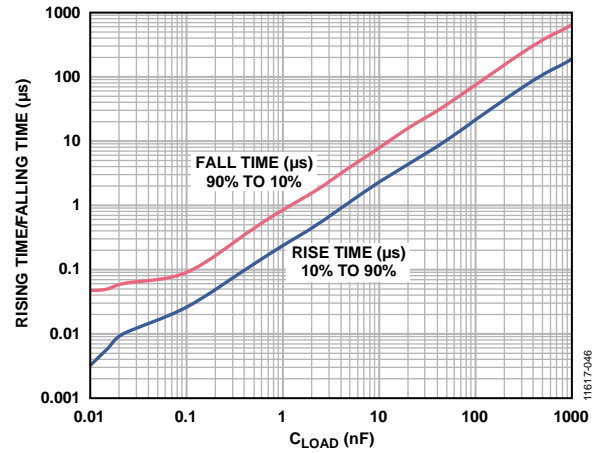

Figure 43. Rising Time/Falling Time vs.  $C_{LOAD}$  for a 1 GHz Modulated Pulsed Waveform with  $P_{IN} = 0$  dBm

## EVALUATION BOARD

The [ADL6010-EVALZ](#) is a fully populated, 4-layer, Rogers 4003-based evaluation board. For normal operation, it only requires a 5 V supply connected to VPOS and GND. The RF input signal is accepted at a high performance 2.92 mm

connector (RFIN). The output voltage is available on the SMA connector (VOUT) or on the test loop (V\_OUT). Configuration options for the evaluation board are listed in Table 4.

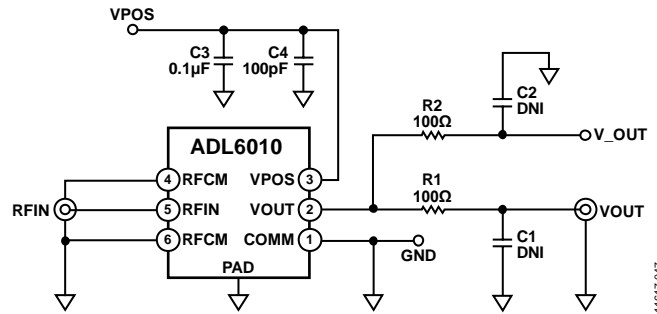

Figure 44. [ADL6010](#) Evaluation Board Schematic

Table 4. Evaluation Board Configuration Options

Component	Function/Comments	Default Value
R1, R2	Output interfaces. Use a 100 Ω series resistor when driving highly capacitive loads. R2 can be replaced with a 0 Ω resistor.	R1 = 100 Ω (0402 size), R2 = 100 Ω (0402 size)
C1, C2	Output load capacitors. Capacitive load at the output that provides the option of tailoring the RF burst response time. The pads of the capacitors are left open by default.	C1, C2 = open
C3, C4	Bypass capacitors. The capacitors provide supply ac decoupling by forming a return path for the ac signal and reducing the noise reaching the input circuitry. The typical value is 0.1 μF.	C3 = 0.1 μF (0402 size), C4 = 100 pF (0402 size)
RFIN	RF input. Southwest Microwave 2.92 mm connector is used for input interface. To prevent the potential damage of the connectors, 2.92 mm (K type) cables are recommended.	

EVALUATION BOARD ASSEMBLY DRAWINGS

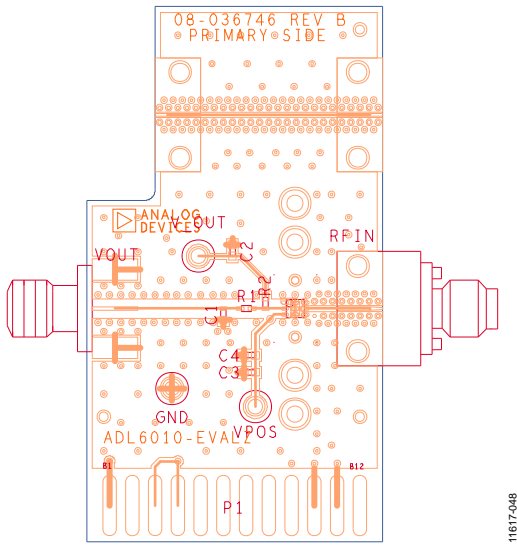

Figure 45. ADL6010 Evaluation Board Layout, Top Side

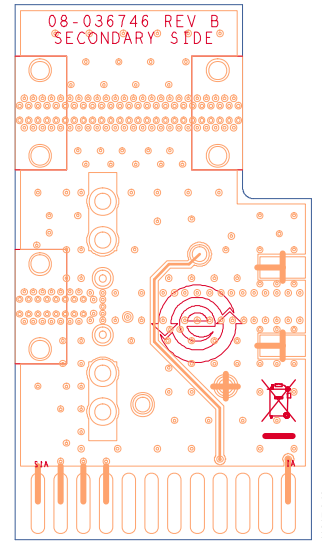

Figure 46. ADL6010 Evaluation Board Layout, Bottom Side

OUTLINE DIMENSIONS

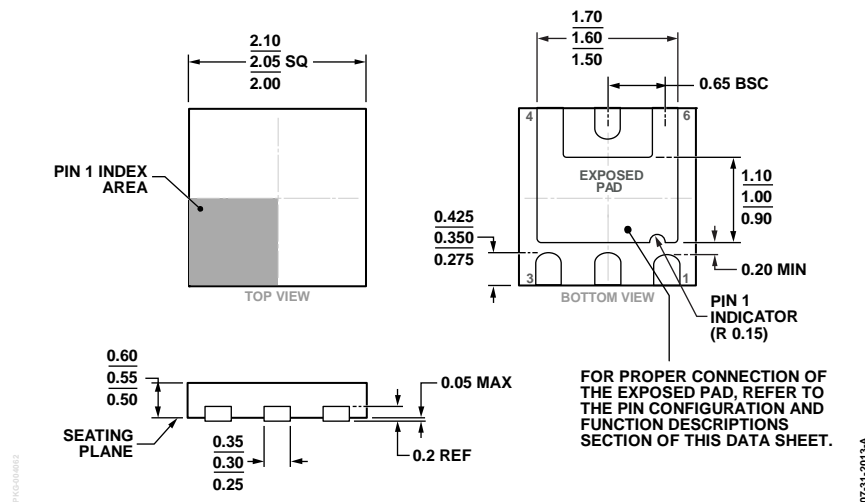

Figure 47. 6-Lead Lead Frame Chip Scale Package [LFCSP\_UD]  
 2 mm × 2 mm Body, Ultrathin, Dual Lead  
 (CP-6-7)  
 Dimensions shown in millimeters

ORDERING GUIDE

Model <sup>1</sup>	Temperature Range	Package Description	Package Option	Ordering Quantity	Branding
ADL6010ACPZN-R7	-40°C to +85°C	6-Lead Lead Frame Chip Scale Package [LFCSP_UD]	CP-6-7	3000	C1
ADL6010SCPZN-R7	-55°C to +125°C	6-Lead Lead Frame Chip Scale Package [LFCSP_UD]	CP-6-7	3000	Q23
ADL6010-EVALZ		Evaluation Board		1	

<sup>1</sup> Z = RoHS Compliant Part.