

## 600mA Low Dropout Fast Response Positive Fixed 1.2V Regulator

### Features

- **Guaranteed Output Voltage Accuracy within 2%**
- **Fast Transient Response**
- **Guaranteed Dropout Voltage at Multiple Currents**
- **Load Regulation : 0.4% Typ.**
- **Line Regulation : 1mV Typ.**
- **Low Dropout Voltage : 1.4V Typ. at  $I_{OUT} = 600mA$**
- **Current Limit : 0.8A Min. at  $T_j = 25^\circ C$**
- **On-Chip Thermal Limiting : 150°C Typ.**
- **Fixed Output : 1.2V**
- **Standard 3-pin, SOT-89 and SOT-223 Package**
- **Lead Free Available (RoHS Compliant)**

### General Description

The APL1187 is a low dropout three-terminal adjustable regulators with 0.6A output current capability. In order to obtain lower dropout voltage and faster transient response, which is critical for low voltage applications, the APL1187 has been optimized.

The device is available in 1.2V with an input supply below 9V. Dropout voltage is guaranteed at a maximum of 1.55V at 0.6A.

Current limit is trimmed to ensure specified output current and controlled short-circuit current. On-chip thermal limiting provides protection against any combination of overload that would create excessive junction temperatures.

The APL1187 is available in the industry standard 3-pin, SOT-89 and SOT-223 package.

### Typical Application Circuit

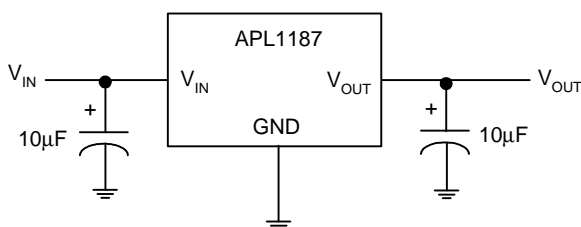

### Applications

- **Voltage Regulator for CD-ROM Drivers**
- **Voltage Regulator for LAN Cards**
- **Voltage Regulator for mother Boards**
- **Wireless Communication Systems**
- **Portable Instrument**
- **Portable Consumer Equipment**
- **Low Voltage Systems**

### Ordering and Marking Information

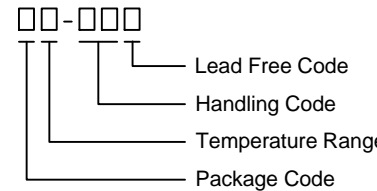
APL1187-		Package Code D : SOT-89                      V : SOT-223 Operating Ambient Temperature Range E : -20 to 70°C Handling Code TU : Tube                      TR : Tape & Reel Voltage Code 12 : 1.2V                      Blank : Adjustable Version Lead Free Code L : Lead Free Device      Blank : Original Device
APL1187-12 D:	<div style="border: 1px solid black; padding: 2px; display: inline-block;">                     APL1187                      XXXXX12                 </div>	XXXXXX - Date Code
APL1187-12 V:	<div style="border: 1px solid black; padding: 2px; display: inline-block;">                     APL1187                      XXXXX12                 </div>	XXXXXX - Date Code

Note: ANPEC lead-free products contain molding compounds/die attach materials and 100% matte tin plate termination finish; which are fully compliant with RoHS and compatible with both SnPb and lead-free soldering operations. ANPEC lead-free products meet or exceed the lead-free requirements of IPC/JEDEC J STD-020C for MSL classification at lead-free peak reflow temperature.

ANPEC reserves the right to make changes to improve reliability or manufacturability without notice, and advise customers to obtain the latest version of relevant information to verify before placing orders.

## Pin Configurations

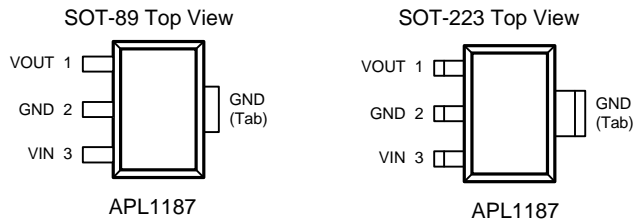

## Absolute Maximum Ratings (Note 1,2)

Symbol	Parameter	Rating	Unit
$V_I$	Input Voltage	9	V
$P_D$	Power Dissipation, $T_A=25^\circ\text{C}$	1.3	W
$T_J$	Operating Junction Temperature Range	0 to 150	$^\circ\text{C}$
$T_{STG}$	Storage Temperature Range	-65 to +150	$^\circ\text{C}$
$T_L$	Lead Temperature (Soldering, 10 second)	260	$^\circ\text{C}$
$\theta_{JA}$	Thermal Resistance from Junction to Ambient		
	SOT-89	130	$^\circ\text{C/W}$
	SOT-223	75	
$\theta_{JC}$	Thermal Resistance from Junction to Case		
	SOT-89	40	$^\circ\text{C/W}$
	SOT-223	15	

Note 1: Stresses beyond the absolute maximum rating may damage the device and operating in the absolute maximum rating conditions may affect device reliability.

Note 2: The maximum allowable power dissipation at any  $T_A$  (ambient temperature) is calculated using:  $P_D(\text{max}) = (T_J - T_A) / \theta_{JA}$ ;  $T_J = 125^\circ\text{C}$ . Exceeding the maximum allowable power dissipation will result in excessive die temperature.

## Electrical Characteristics

Symbol	Parameter	Test Conditions	APL1187			Unit
			Min	Typ	Max	
$V_{OUT}$	Output Voltage APL1187-12	$T_J=0\sim 125^\circ\text{C}$ , $0\leq I_{OUT}\leq 0.6\text{A}$ , $2.8\text{V}\leq V_{IN}\leq 9\text{V}$ ,	1.176	1.200	1.224	V
$V_{IN}$	Input Voltage		2.8		9	V
$REG_{LINE}$	Line Regulation APL1087-12	$T_J=0\sim 125^\circ\text{C}$ , $I_{OUT}=0\text{mA}$ , $2.8\text{V}\leq V_{IN}\leq 9\text{V}$ (note3)		1	6	mV
$REG_{LOAD}$	Load Regulation APL1187-12	$T_J=0\sim 125^\circ\text{C}$ , $V_{IN}=2.8\text{V}$ , $0\leq I_{OUT}\leq 0.6\text{A}$ (note 3)		0.4	0.6	%
$V_D$	Dropout Voltage	$I_{OUT}=0.6\text{A}$ , $T_J=0\sim 125^\circ\text{C}$		1.4	1.55	V
$I_{LIMIT}$	Current Limit	$(V_{IN}-V_{OUT})=5\text{V}$ , $T_J=25^\circ\text{C}$	800			mA
PSRR	Ripple Rejection	$F_{RIPPLE}=120\text{Hz}$ , $V_{RIPPLE}=1\text{V}_{P-P}$ , $(V_{IN}-V_{OUT})=3\text{V}$ , $T_J=0\sim 125^\circ\text{C}$	60	75		dB
OT	Over Temperature Point			150		$^\circ\text{C}$
	OTP Hysteresis			20		$^\circ\text{C}$
$I_Q$	Quiescent Current APL1187-12	$T_J=0\sim 125^\circ\text{C}$ , $V_{IN}\leq 9\text{V}$		5.5	10	mA

Note 3: See thermal regulation specifications for changes in output voltage due to heating effects. Load line regulations are measured at a constant junction temperature by low duty cycle pulse testing.

Note 4: Dropout voltage is specified over the full output current range of the device. Dropout voltage is defined as the minimum input/output differential measured at the specified output current. Test points and limits are also shown on the Dropout Voltage curve.

## Typical Operating Characteristics

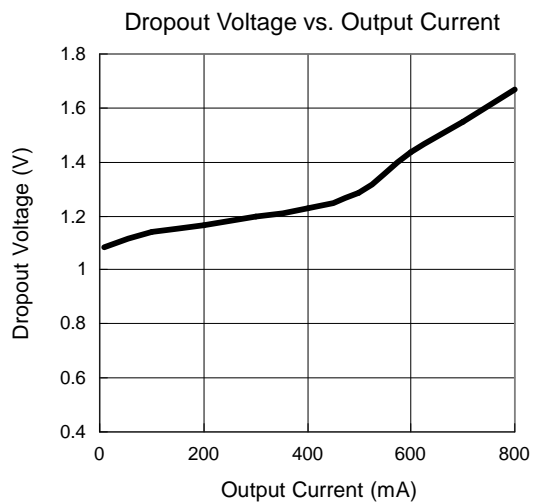
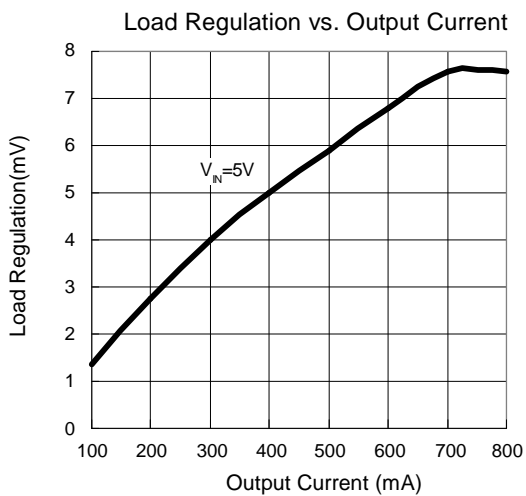
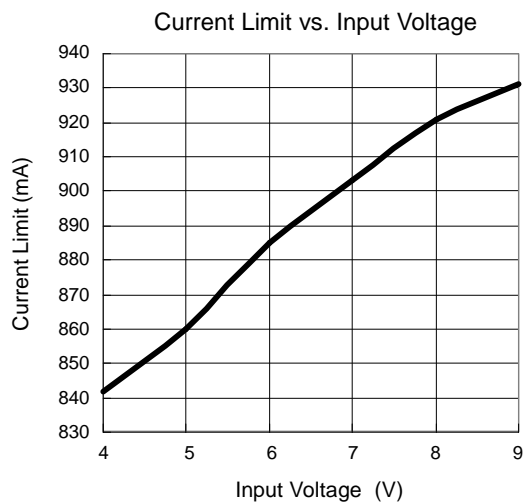
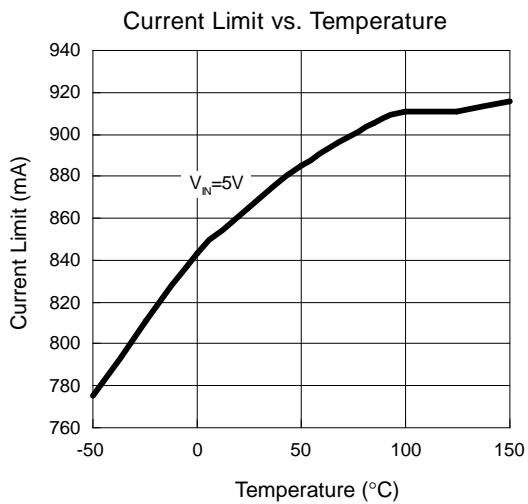
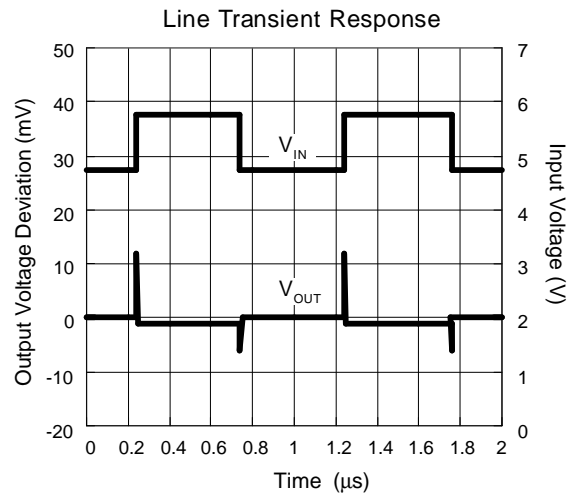
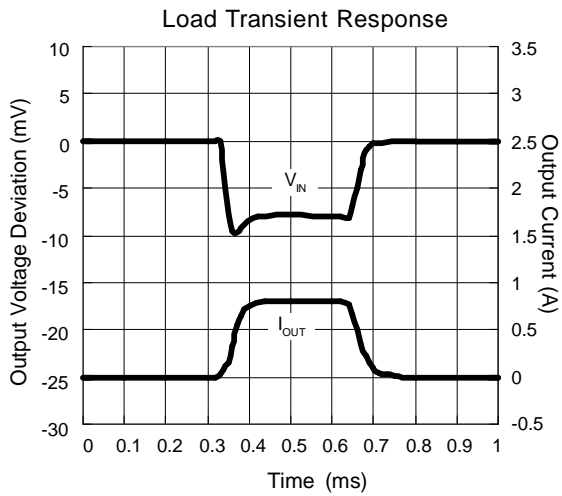

### Typical Operating Characteristics (Cont.)

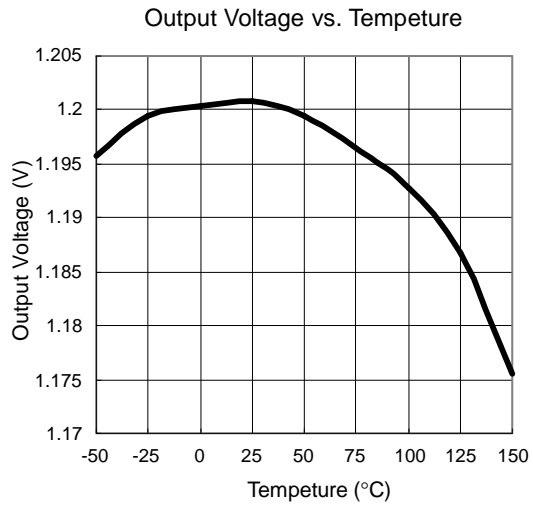

## Packaging Information

SOT89

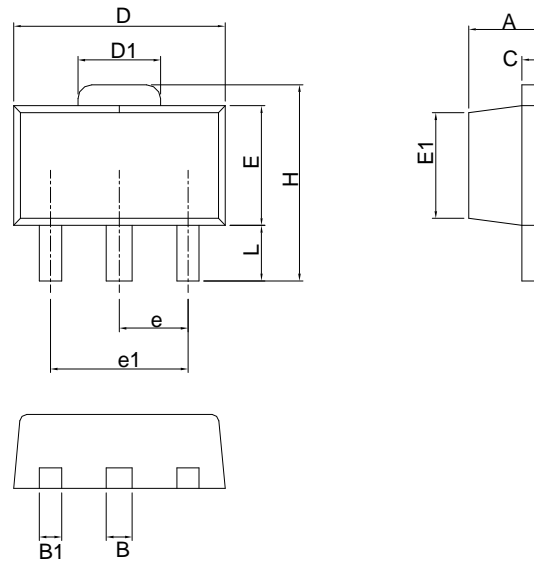

SYMBOL	SOT89			
	MILLIMETERS		INCHES	
	MIN.	MAX.	MIN.	MAX.
A	1.40	1.60	0.055	0.063
B	0.44	0.56	0.017	0.022
B1	0.36	0.48	0.014	0.019
C	0.35	0.44	0.014	0.017
D	4.40	4.60	0.173	0.181
D1	1.62	1.83	0.064	0.072
E	2.29	2.60	0.090	0.102
E1	2.13	2.29	0.084	0.090
e	1.50 BSC		0.059 BSC	
e1	3.00 BSC		0.118 BSC	
H	3.94	4.25	0.155	0.167
L	0.89	1.20	0.035	0.047

Packaging Information

SOT223

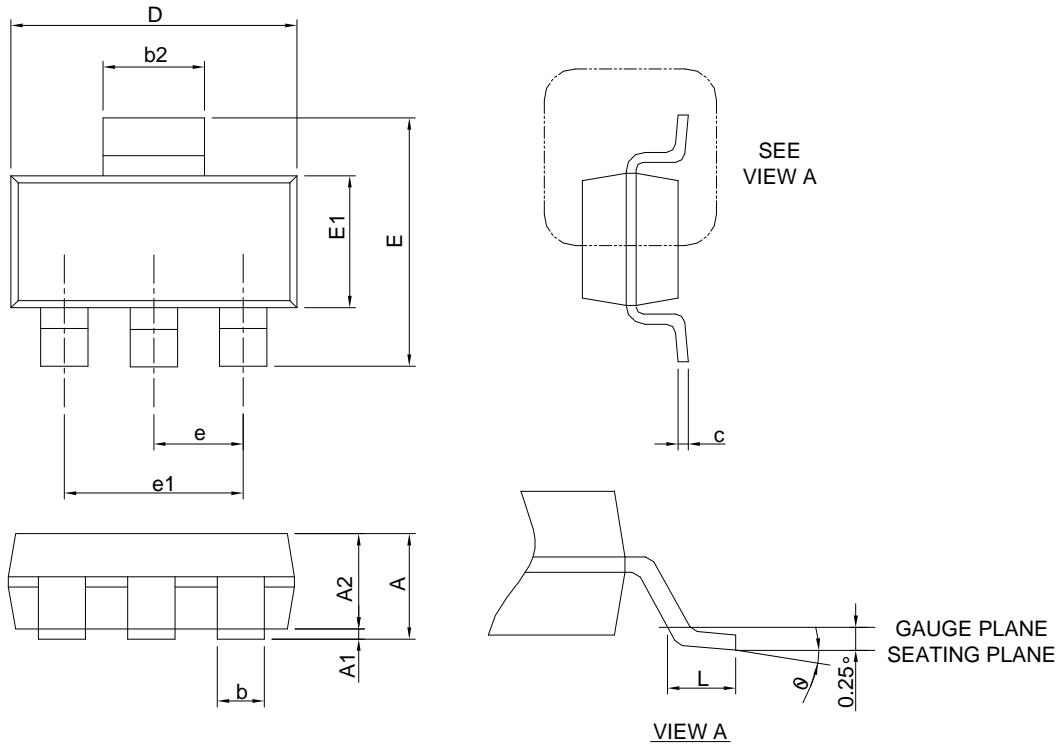

DIMENSIONS	SOT223			
	MILLIMETERS		INCHES	
	MIN.	MAX.	MIN.	MAX.
A		1.80		0.071
A1	0.02	0.10	0.001	0.004
A2	1.50	1.70	0.059	0.067
b	0.66	0.84	0.026	0.033
b2	2.90	3.10	0.114	0.122
c	0.23	0.33	0.009	0.013
D	6.30	6.70	0.248	0.264
E	6.70	7.30	0.264	0.287
E1	3.30	3.70	0.130	0.146
e	2.30 BSC		0.091 BSC	
e1	4.60 BSC		0.181 BSC	
L	0.75		0.030	
$\theta$	0°	10°	0°	10°

### Carrier Tape & Reel Dimensions

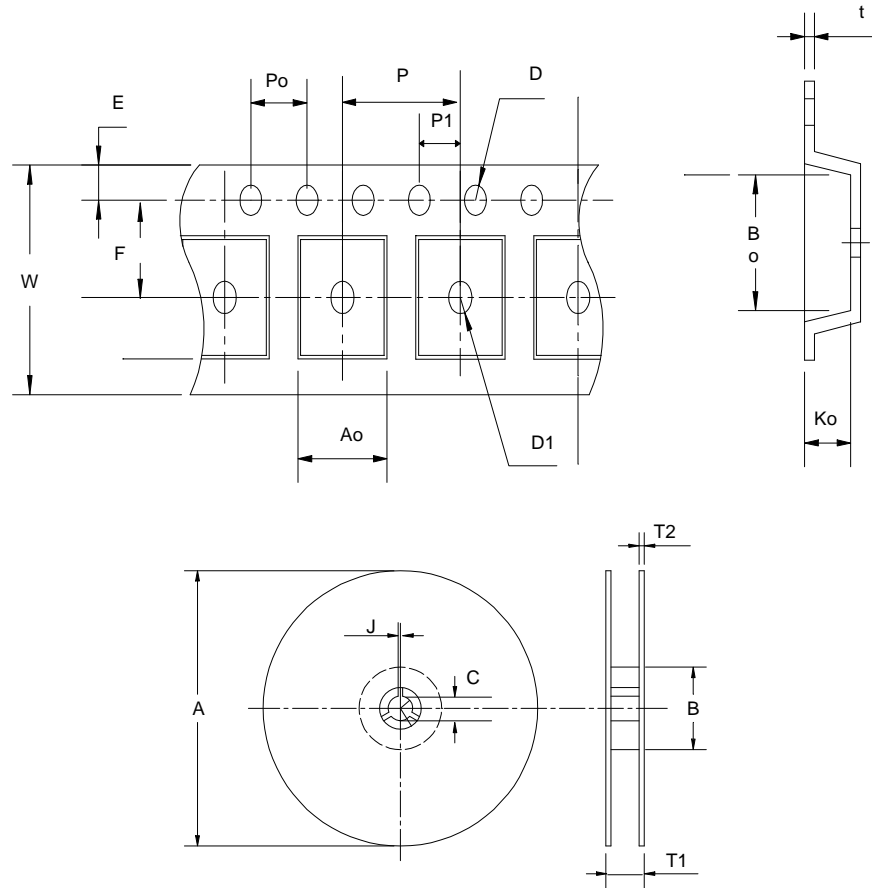

Application	A	B	C	J	T1	T2	W	P	E
SOT-89	178 ±1	70 ±2	13.5 ± 0.15	3 ± 0.15	14 ± 2	1.3 ± 0.3	12 + 0.3 12 - 0.1	8 ± 0.1	1.75 ± 0.1
	F	D	D1	Po	P1	Ao	Bo	Ko	T
	5.5 ± 0.05	1.5 ± 0.1	1.5 ± 0.1	4.0 ± 0.1	2.0 ± 0.1	4.8 ± 0.1	4.5 ± 0.1	1.80 ± 0.1	0.3 ± 0.013
Application	A	B	C	J	T1	T2	W	P	E
SOT-223	330 ±1	62 ±1.5	12.75 ± 0.15	2 ± 0.6	12.4 + 0.2	2 ± 0.2	12 ± 0.3	8 ± 0.1	1.75 ± 0.1
	F	D	D1	Po	P1	Ao	Bo	Ko	T
	5.5 ± 0.05	1.5 ± 0.1	1.5 ± 0.1	4.0 ± 0.1	2.0 ± 0.05	6.9 ± 0.1	7.5 ± 0.1	2.1 ± 0.1	0.3 ± 0.05

(mm)

### Cover Tape Dimensions

Application	Carrier Width	Cover Tape Width	Devices Per Reel
SOT- 89	12	9.3	1000
SOT- 223	12	9.3	2500

## Physical Specifications

Terminal Material	Solder-Plated Copper (Solder Material: 90/10 or 63/37 SnPb), 100%Sn
Lead Solderability	Meets EIA Specification RS186-91, ANSI/J-STD-002 Category 3.

### Reflow Condition (IR/Convection or VPR Reflow)

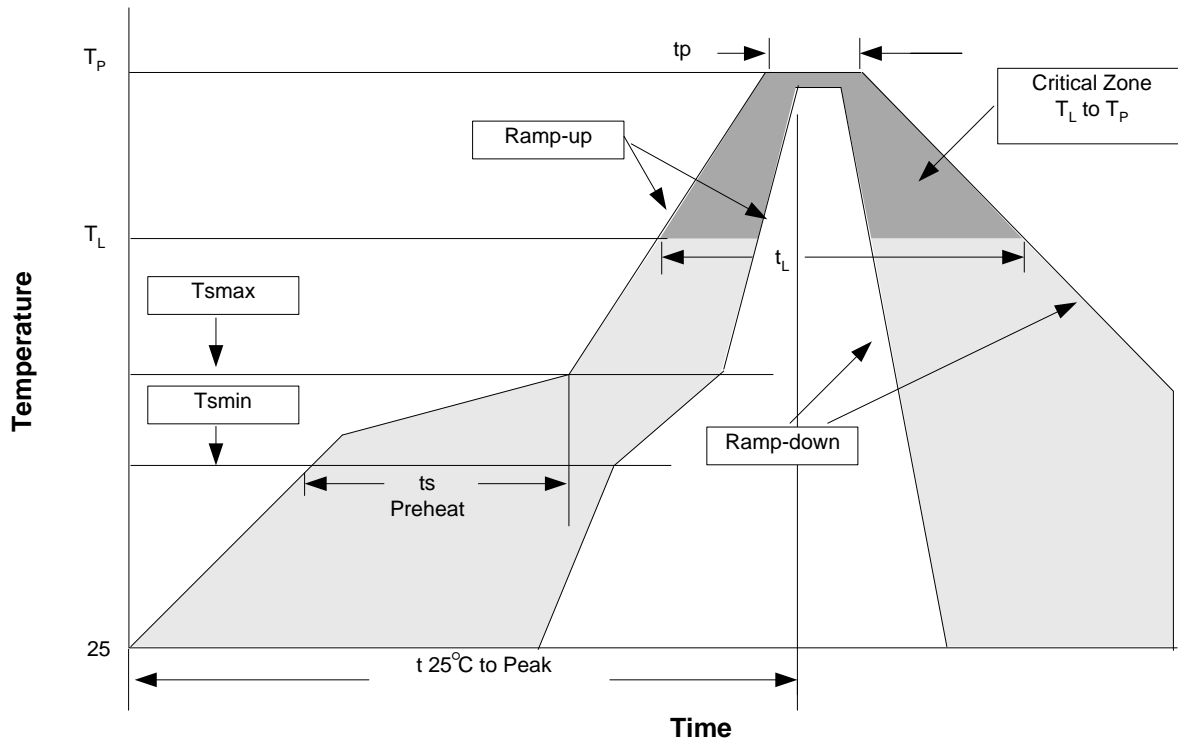

### Classification Reflow Profiles

Profile Feature	Sn-Pb Eutectic Assembly	Pb-Free Assembly
Average ramp-up rate ( $T_L$ to $T_P$ )	3°C/second max.	3°C/second max.
Preheat		
- Temperature Min ( $T_{smin}$ )	100°C	150°C
- Temperature Max ( $T_{smax}$ )	150°C	200°C
- Time (min to max) ( $t_s$ )	60-120 seconds	60-180 seconds
Time maintained above:		
- Temperature ( $T_L$ )	183°C	217°C
- Time ( $t_L$ )	60-150 seconds	60-150 seconds
Peak/Classification Temperature ( $T_p$ )	See table 1	See table 2
Time within 5°C of actual Peak Temperature ( $t_p$ )	10-30 seconds	20-40 seconds
Ramp-down Rate	6°C/second max.	6°C/second max.
Time 25°C to Peak Temperature	6 minutes max.	8 minutes max.

Notes: All temperatures refer to topside of the package. Measured on the body surface.



## Classification Reflow Profiles (Cont.)

Table 1. SnPb Eutectic Process – Package Peak Reflow Temperatures

Package Thickness	Volume mm <sup>3</sup> <350	Volume mm <sup>3</sup> ≥350
<2.5 mm	240 +0/-5°C	225 +0/-5°C
≥2.5 mm	225 +0/-5°C	225 +0/-5°C

Table 2. Pb-free Process – Package Classification Reflow Temperatures

Package Thickness	Volume mm <sup>3</sup> <350	Volume mm <sup>3</sup> 350-2000	Volume mm <sup>3</sup> >2000
<1.6 mm	260 +0°C*	260 +0°C*	260 +0°C*
1.6 mm – 2.5 mm	260 +0°C*	250 +0°C*	245 +0°C*
≥2.5 mm	250 +0°C*	245 +0°C*	245 +0°C*

\* Tolerance: The device manufacturer/supplier **shall** assure process compatibility up to and including the stated classification temperature (this means Peak reflow temperature +0°C. For example 260°C+0°C) at the rated MSL level.

## Reliability Test Program

Test item	Method	Description
SOLDERABILITY	MIL-STD-883D-2003	245°C, 5 SEC
HOLT	MIL-STD-883D-1005.7	1000 Hrs Bias @125°C
PCT	JESD-22-B,A102	168 Hrs, 100%RH, 121°C
TST	MIL-STD-883D-1011.9	-65°C~150°C, 200 Cycles
ESD	MIL-STD-883D-3015.7	VHBM > 2KV, VMM > 200V
Latch-Up	JESD 78	10ms, 1 <sub>tr</sub> > 100mA

## Customer Service

### Anpec Electronics Corp.

Head Office :

No.6, Dusing 1st Road, SBIP,  
Hsin-Chu, Taiwan, R.O.C.  
Tel : 886-3-5642000  
Fax : 886-3-5642050

Taipei Branch :

7F, No. 137, Lane 235, Pac Chiao Rd.,  
Hsin Tien City, Taipei Hsien, Taiwan, R. O. C.  
Tel : 886-2-89191368  
Fax : 886-2-89191369