



ON Semiconductor®

<http://onsemi.com>

LV5011MD

Bi-CMOS LSI

LED Driver IC

Overview

LV5011MD is a High Voltage LED driver with internal power FET.

LV5011MD is realized very simple LED circuits with a few external parts. It corresponds to various wide dimming controls including the TRIAC dimming control.

Note) This LV5011MD is designed or developed for general use or consumer appliance. Therefore, it is NOT permitted to use for automotive, communication, office equipment, and industrial equipment.

Function

- High Voltage LED Driver
- Built-in output power FET
- Built-in TRIAC stabilized function
- Various Dimming Control
 - TRIAC & Analog Input
- Selectable reference Voltage
 - Internal 0.605V & External Input Voltage
- Over Voltage Protection
- Short Protection Circuit

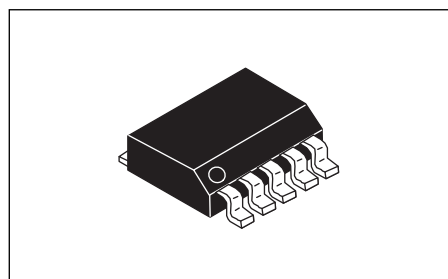

SOIC-10 NB

Specifications

Maximum Ratings at Ta = 25°C

Parameter	Symbol	Conditions	Ratings	unit
Maximum Input voltage	V _{IN} max (Note1)		-0.3 to 42	V
REF_IN, CS, ACS pin			-0.3 to 7	V
Drain pin	V _{Drain_abs}		-0.3 to 600	V
OUT2 pin	V _{OUT2_abs}		-0.3 to 42	V
Allowable power dissipation	P _d max	With specified board *1	0.6	W
Junction temperature	T _j		150	°C
Operating Junction temperature	T _{opj} (Note2)		-30 to +125	°C
Storage temperature	T _{stg}		-40 to +150	°C

*1: Specified board=35mm×16.5mm×1.2mm, glass epoxy board

Note1) Absolute maximum ratings represent the values which cannot be exceeded for any length of time.

Note2) Even when the device is used within the range of absolute maximum ratings, as a result of continuous usage under high temperature, high current, high voltage, or drastic temperature change, the reliability of the IC may be degraded. Please contact us for the further details.

Stresses exceeding Maximum Ratings may damage the device. Maximum Ratings are stress ratings only. Functional operation above the Recommended Operating Conditions is not implied. Extended exposure to stresses above the Recommended Operating Conditions may affect device reliability.

ORDERING INFORMATION

See detailed ordering and shipping information on page 10 of this data sheet.

LV5011MD

Recommended Operating Conditions at Ta = 25°C

Parameter	Symbol	Conditions	Ratings	Unit
Input voltage	V _{IN}		8.5 to 24	V

Electrical Characteristics at Ta = 25°C, V_{IN} = 12V, unless otherwise specified.

Parameter	Symbol	Conditions	Ratings			Unit
			min	typ	max	
Reference Voltage block						
Built-in Reference Voltage	VREF		0.585	0.605	0.625	V
VREF V _{IN} line regulation	VREF_LN	V _{IN} = 8.5 to 24V		±0.5		%
Under Voltage Lockout						
Operation Start Input Voltage	UVLOON		8	9	10	V
Operation Stop Input Voltage	UVLOOFF		6.3	7.3	8.3	V
Hysteresis Voltage	UVLOH			1.7		V
Oscillation						
Frequency	FOSC		55	70	85	kHz
Maximum ON duty	MAXDuty			93		%
Comparator						
Input offset Voltage (Between CS and REF_IN)	V _{IO_RI}			1	10	mV
Input current	I _{IOCS}			160		nA
	I _{IOREF}			80		nA
CS pin max voltage	VOM				1	V
FET output stage						
Drain Leakage current	ILK	V _{Drain} =480V			100	μA
Power FET ON resistor	R _{on}	V _{IN} =12V		9.5		Ω
Minimum On time	T _{MIN}			200		ns
Thermal protection Circuit						
Thermal shutdown temperature	TSD	*Design guarantee		165		°C
Thermal shutdown hysteresis	ΔTSD	*Design guarantee		30		°C
TRIAC Stabilization Circuit						
Threshold of OUT2	VACS	OUT2=High [less than right record]	2.8	3.0	3.2	V
OUT2 sink current	I _{O2I}	V _{IN} =12V, OUT2=6V		0.6		mA
OUT2 source current	I _{O2O}	V _{IN} =12V, OUT2=6V		0.6		mA
V_{CC} current						
UVLO mode V _{IN} current	I _{CCOFF}	V _{IN} <UVLOOFF		120	160	μA
Normal mode V _{IN} current	I _{CCON}	V _{IN} =12V		1.0		mA
V_{IN} Over Voltage Protection Circuit						
V _{IN} over voltage protection voltage	V _{IN} OVP		24	27	30	V
V _{IN} Current at OVP	I _{INOVP}	V _{IN} =30V	0.7	1.0	1.5	mA
CS terminal abnormal sensing circuit						
Abnormal sensing voltage	CSOCP			1.9		V

*: Design guarantee (value guaranteed by design and not tested before shipment)

LV5011MD

Block Diagram

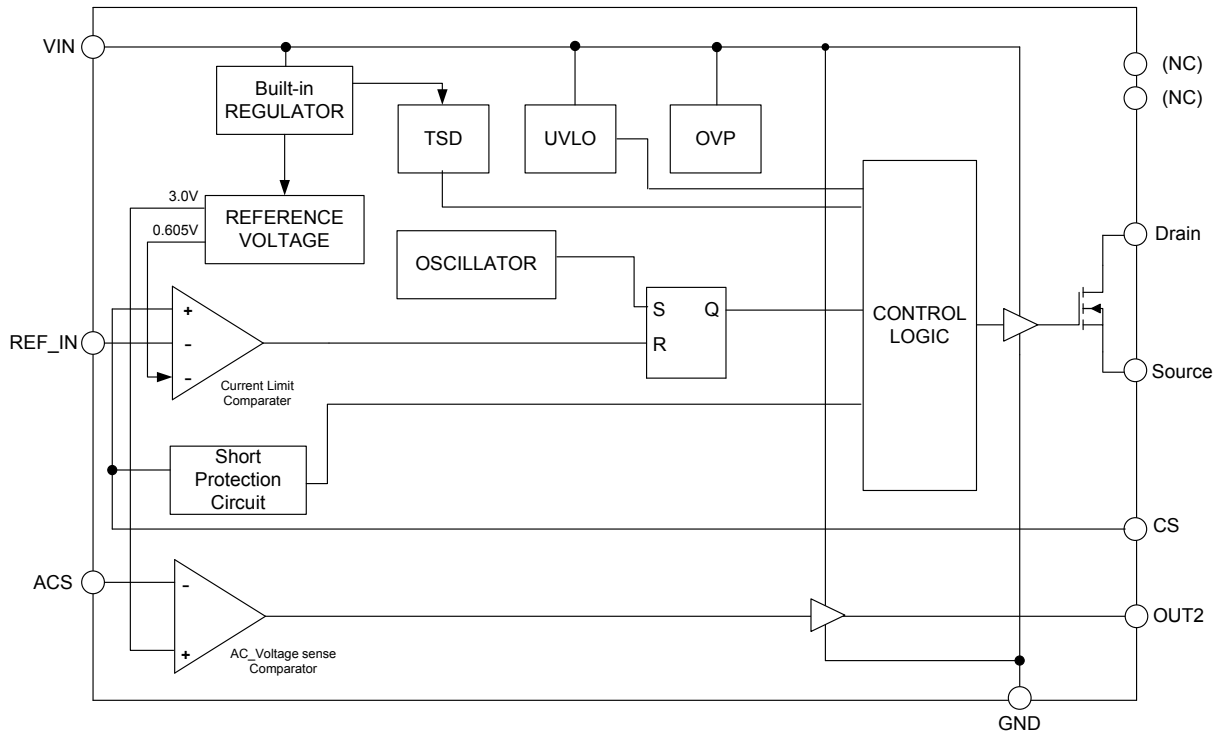

Sample Application Circuit

Non-isolation>

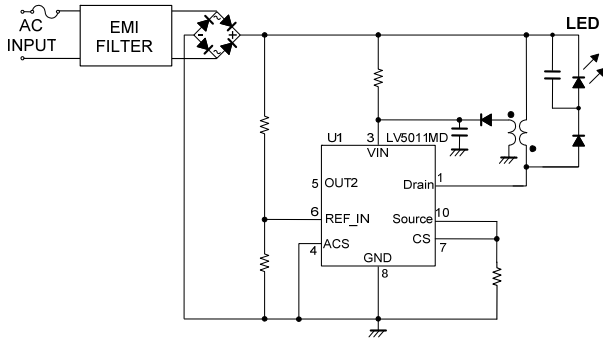

Isolation>

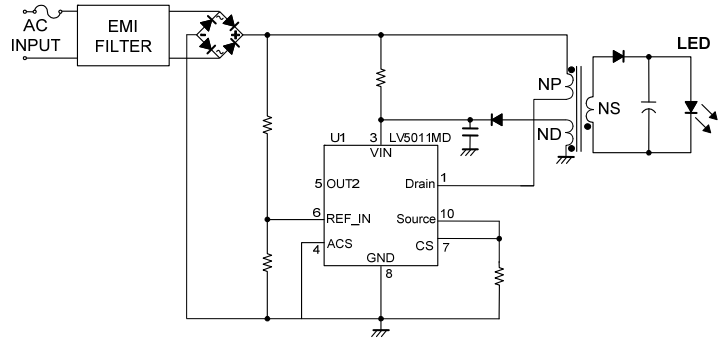

LV5011MD

Package Dimensions

unit : mm

SOIC- 10 NB

CASE 751BQ- 01

ISSUE A

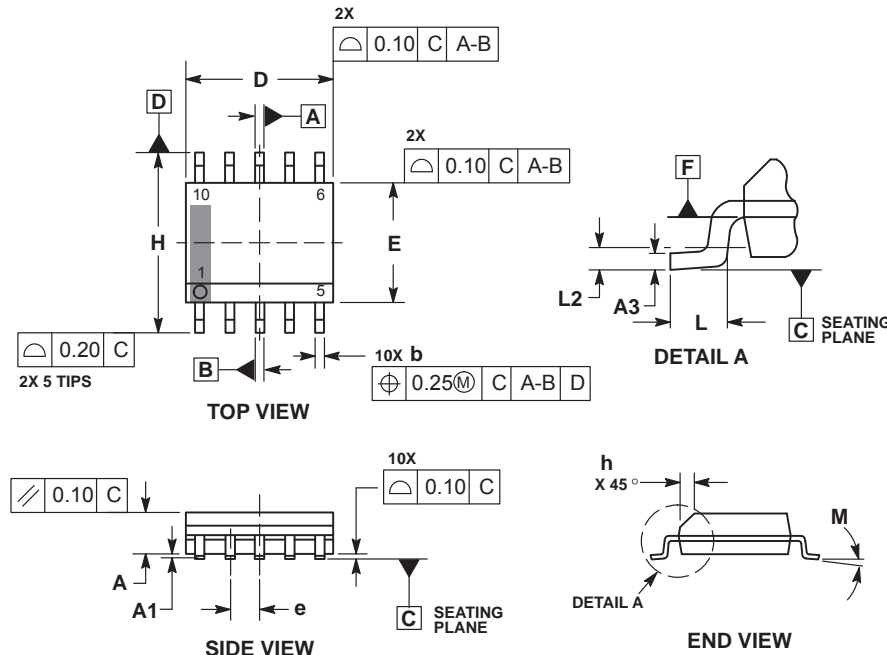

NOTES:

1. DIMENSIONING AND TOLERANCING PER ASME Y14.5M, 1994.
2. CONTROLLING DIMENSION: MILLIMETERS.
3. DIMENSION b DOES NOT INCLUDE DAMBAR PROTRUSION. ALLOWABLE PROTRUSION SHALL BE 0.10mm TOTAL IN EXCESS OF b AT MAXIMUM MATERIAL CONDITION.
4. DIMENSIONS D AND E DO NOT INCLUDE MOLD FLASH, PROTRUSIONS, OR GATE BURRS. MOLD FLASH, PROTRUSIONS, OR GATE BURRS SHALL NOT EXCEED 0.15mm PER SIDE. DIMENSIONS D AND E ARE DETERMINED AT DATUM F.
5. DIMENSIONS A AND B ARE TO BE DETERMINED AT DATUM F.
6. A1 IS DEFINED AS THE VERTICAL DISTANCE FROM THE SEATING PLANE TO THE LOWEST POINT ON THE PACKAGE BODY.

MILLIMETERS		
DIM	MIN	MAX
A	1.25	1.75
A1	0.10	0.25
A3	0.17	0.25
b	0.31	0.51
D	4.80	5.00
E	3.80	4.00
e	1.00 BSC	
H	5.80	6.20
h	0.37 REF	
L	0.40	1.27
L2	0.25 BSC	
M	0°	8°

GENERIC MARKING DIAGRAM*

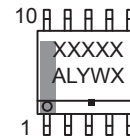

- XXXXX = Specific Device Code
- A = Assembly Location
- L = Wafer Lot
- Y = Year
- W = Work Week
- = Pb-Free Package

*This information is generic. Please refer to device data sheet for actual part marking. Pb-Free indicator, G, may or not be present.

RECOMMENDED SOLDERING FOOTPRINT*

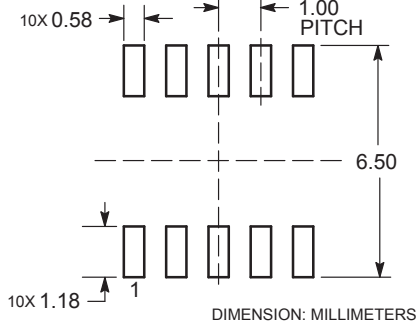

*For additional information on our Pb-Free strategy and soldering details, please download the ON Semiconductor Soldering and Mounting Techniques Reference Manual, SOLDERM/D.

Pin Assignment

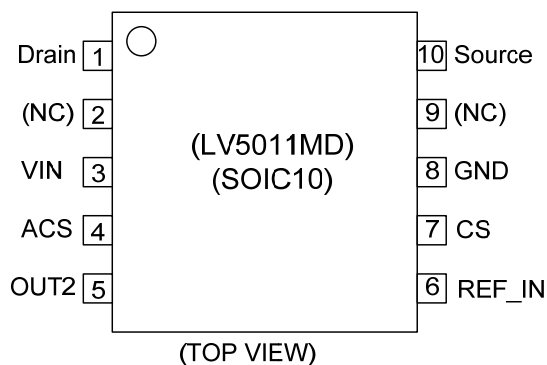

Pd max - Ta

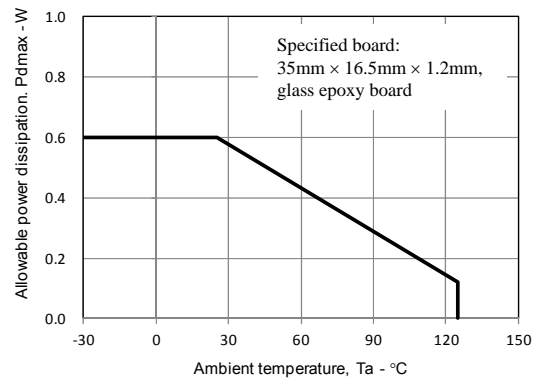

LV5011MD

Pin Functions

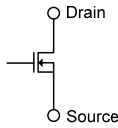
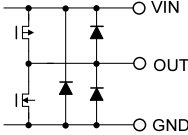
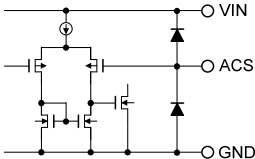
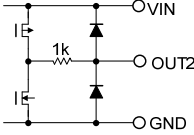
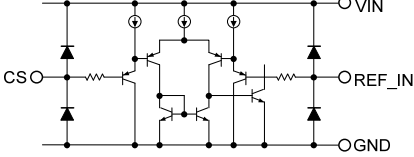
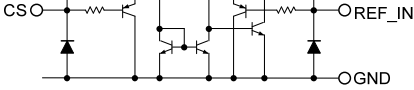
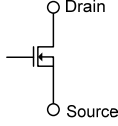
Pin No	Pin Name	Pin Function	Equivalent Circuit
1	Drain	Drain pin of built-in power FET	
2	(NC)	No connect pin	
3	VIN	Power supply pin. Under voltage lock out VIN<UVLOFF(7.3V): Stop VIN>UVLOON(9V): Operation Over voltage protection VIN>VINOVP(27V): Switching Stop	
4	ACS	ACS pin senses AC Voltage. This pin is used to stabilize the TRIAC dimming application. ACS pin>3V : OUT2=Low ACS pin<3V : OUT2=High If this function isn't used, please connect GND.	
5	OUT2	OUT2 pin drives the gate of TRIAC bleeder, which stabilizes dimming function. If dimming function not used, do not connect. If ACS is below 3V, OUT2 is high (VIN).	
6	REF_IN	External LED current limit set pin (ILimit). If pin 6 < 0.605V, then Ipeak value is used for REF_IN. If pin 6 > 0.605V, then Ipeak value is used for 0.605V (internal reference).	
7	CS	LED current sensing in. If this terminal voltage exceeds VREF (or REF_IN), external FET is OFF. And if the voltage of the terminal exceeds 1.9V, LV5011MD turns to latch-off mode.	
8	GND	GND pin	
9	(NC)	No connect pin	
10	Source	Source pin of built-in FET	

LV5011MD

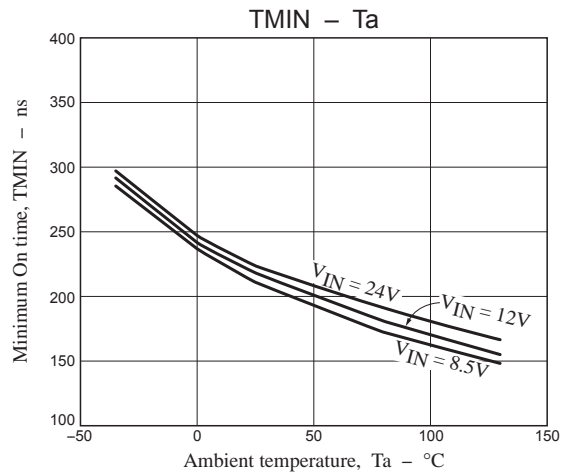
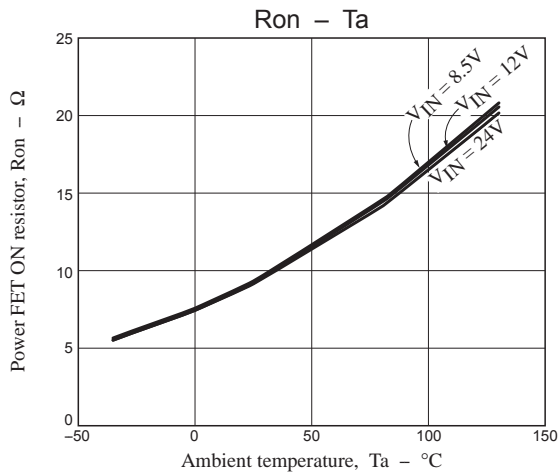
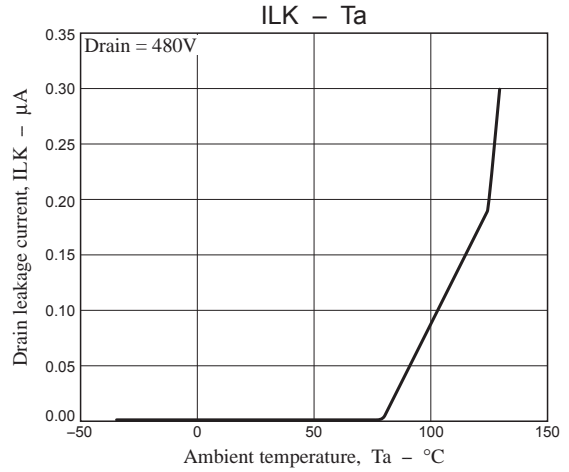
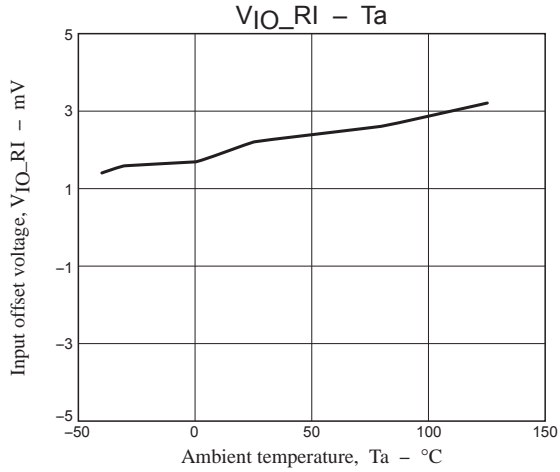
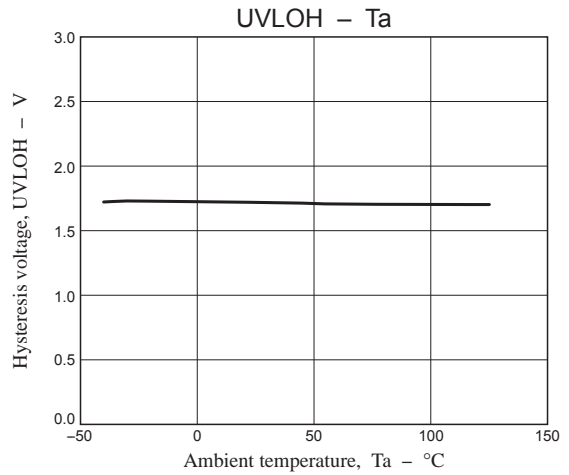
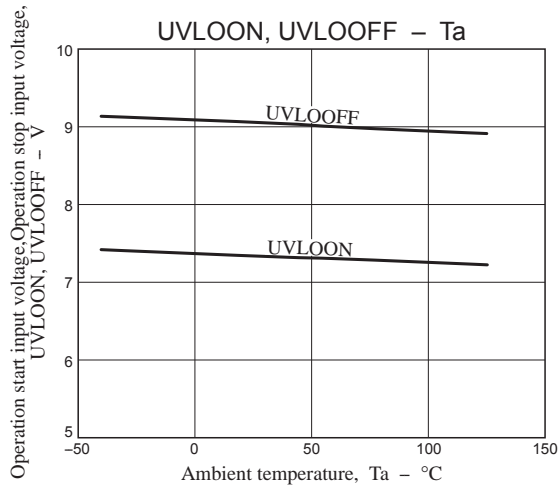
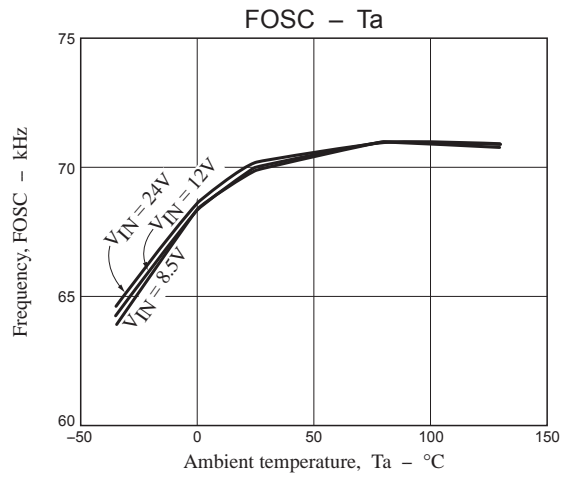
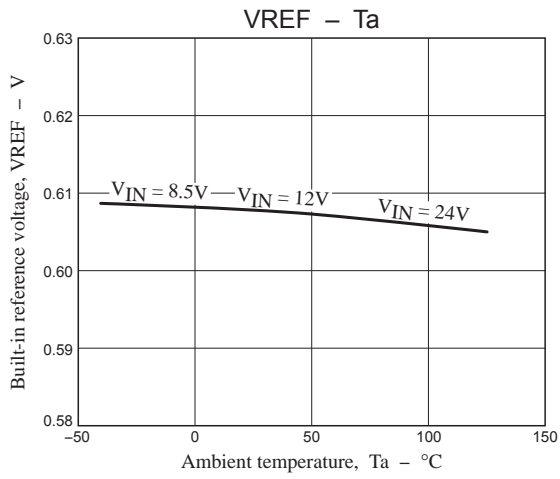

LV5011MD

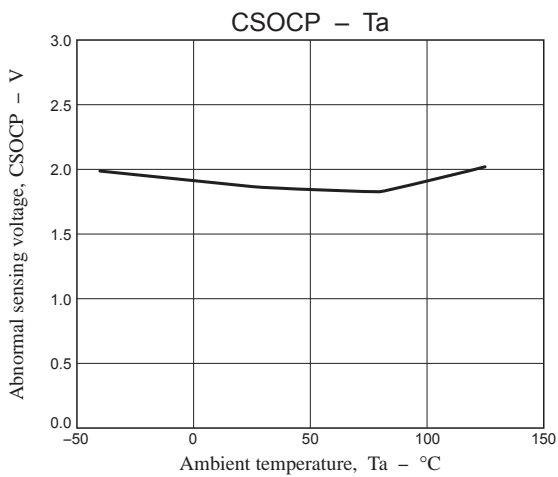
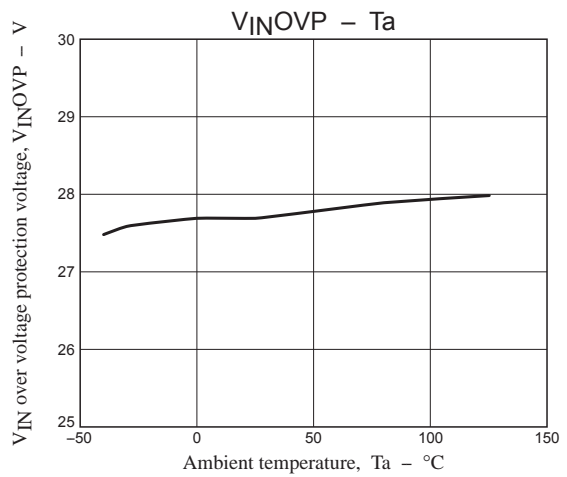
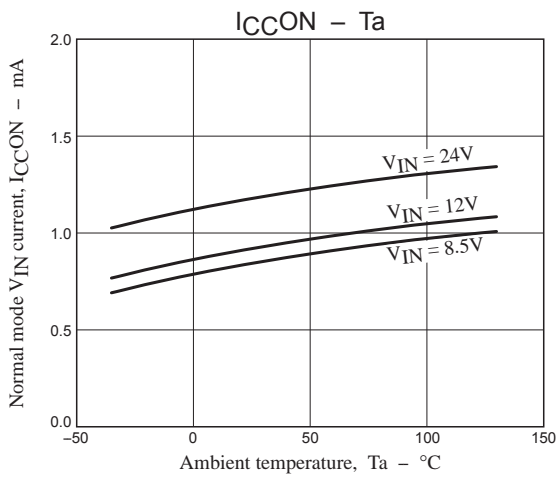
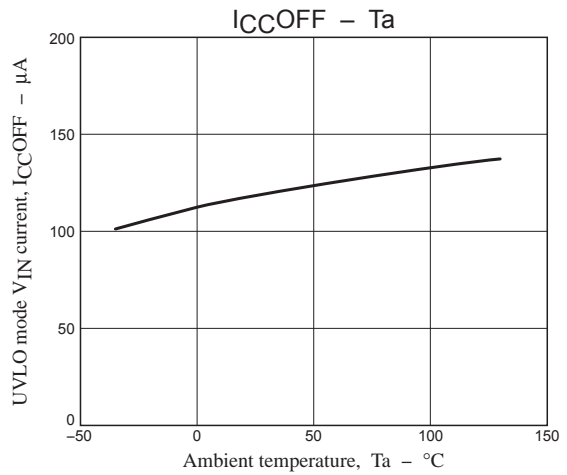
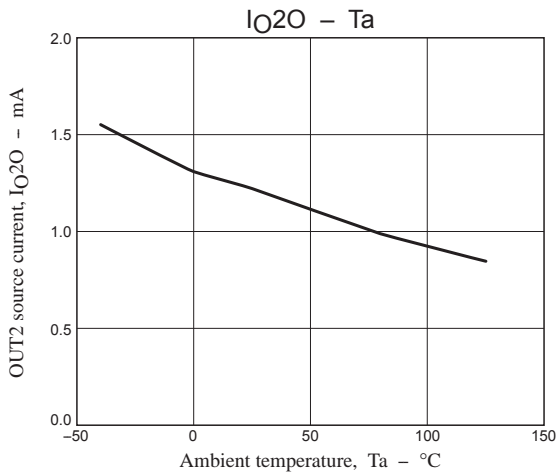
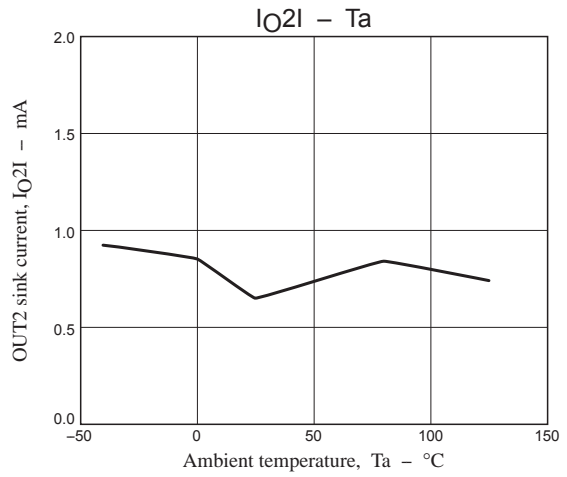
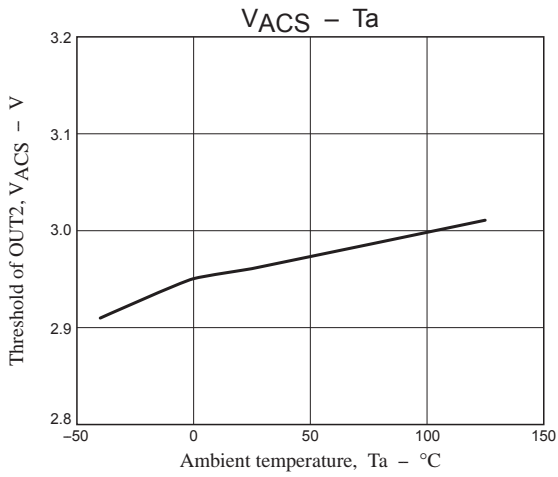

Functional description

LV5011MD is an LED driver IC that operates directly from the rectified AC voltage. LV5011MD controls brightness of the LED by controlling a peak current of the internal MOSFET.

1. Peak current control

LV5011MD detects the current of internal MOSFET as shown in the following diagram. The current that flows into MOSFET is a triangular wave shown in the diagram. The current peak value is determined by the relationship between the reference level and CS voltage. This relationship makes Power Factor Correction (PFC). CS voltage is used by internal comparator to compare to the reference level. LV5011MD controls the peak value of MOSFET current. Here, the reference level is lower value of either “REF_IN” or “VREF(0.605V)”.

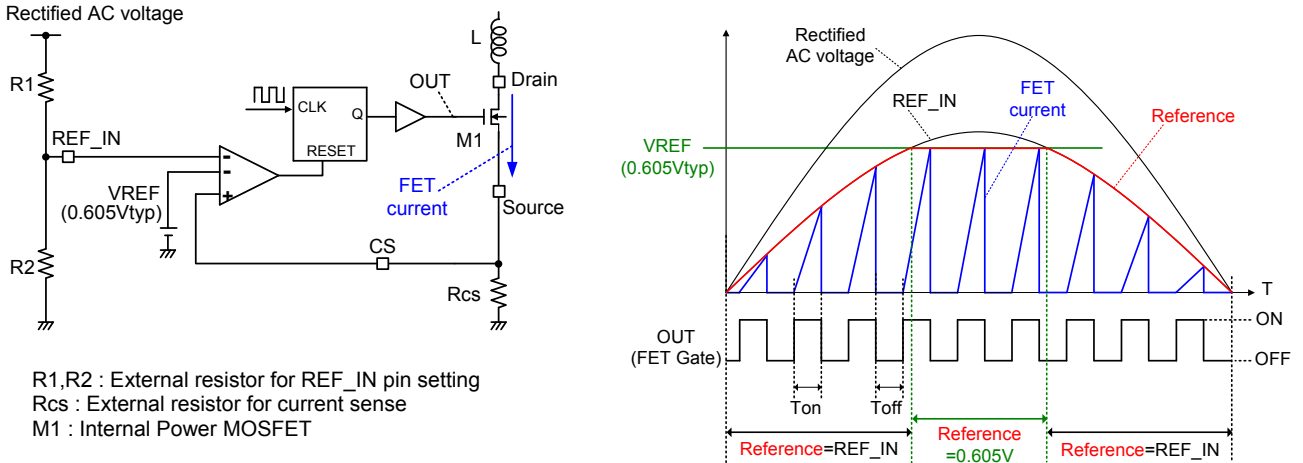

The peak value of MOSFET current (I_{pk}) is determined by :

$$\text{In the case of "REF_IN < VREF(0.605V)" } \rightarrow I_{pk} = \frac{REF_IN}{R_{cs}}$$

$$\text{In the case of "REF_IN > VREF(0.605V)" } \rightarrow I_{pk} = \frac{0.605V}{R_{cs}}$$

2. Bleeder current circuit for TRIAC dimming

LV5011MD contains the bleeder current circuit for TRIAC dimming. Please connect OUT2 to the external MOSFET gate and connect the resistor “Rd” to its drain.

2-1. Operating voltage setting

OUT2 pin is controlled by setting value on ACS pin. When ACS pin voltage is below 3V, OUT2 is high and external FET is turned on. The bleeder operation threshold of the rectified AC is determined below.

$$Vac_bleeder = \frac{R3 + R4}{R4} \times 3V$$

2-2. Bleeder current setting

Bleeder current is set by Rd. Please calculate Rd value based on TRIAC dimmer.

Waveforms diagram

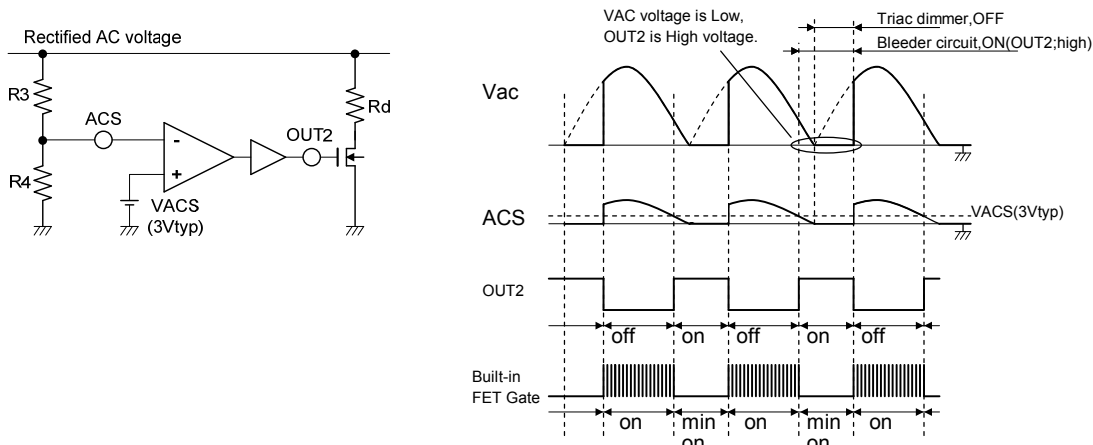

3. Protection Function

	Tilte	outline	monitor point
3.1	UVLO	Under Voltage Lock Out	VIN voltage
3.2	OCP	Over Current Protection	CS voltage
3.3	OVP	Over Voltage Protection	VIN voltage
3.4	OTP (TSD)	Over Temperature Protection (Thermal Shut Down)	PN Junction temperature

3.1 UVLO(Under Voltage Lock Out)

If VIN voltage is 7.3V or lower, then UVLO operates and the IC stops. When UVLO operates, the power supply current of the IC is about 120µA or lower. If VIN voltage is 9V or higher, then the IC starts switching operation.

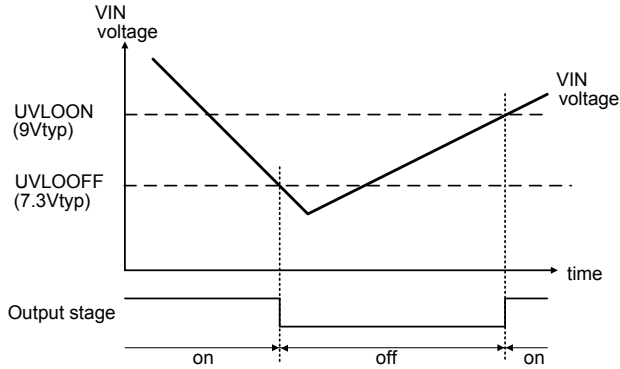

3.2 OCP(Over Current Protection)

CS pin is used to sense current in primary winding of transformer via internal HV MOSFET. This provides an additional level of protection in the event of a fault. If the voltage of the CS pin exceeds VCSOCP(1.9V typ.)(A), the internal comparator will detect the event and turn off the MOSFET. The peak switch current is calculated

$$I_{ocp(peak)} [A] = V_{CSOCP}[V] / R_{cs}[\Omega]$$

The VIN pin is pulled down to fixed level, keeping the controller latched off. The latch reset occurs when the user disconnects LED from VAC and lets the VIN falls below the VIN reset voltage, UVLOOFF(7.3V typ.)(B). Switching restarts when VIN rises to UVLOON(9V typ.)(C).

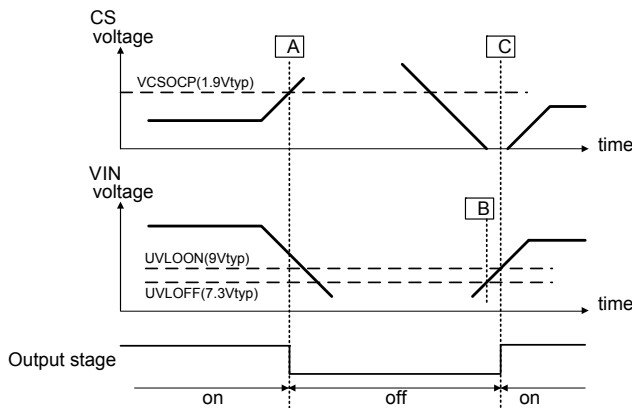

3.3 OVP(Over Voltage Protection)

If the voltage of VIN pin is higher than the internal reference voltage VINOVP(27V typ.), switching operation is stopped. The IC(device) will not restart till reset voltage <7.3V and then rise to 9V. Please see OVP waveform chart.

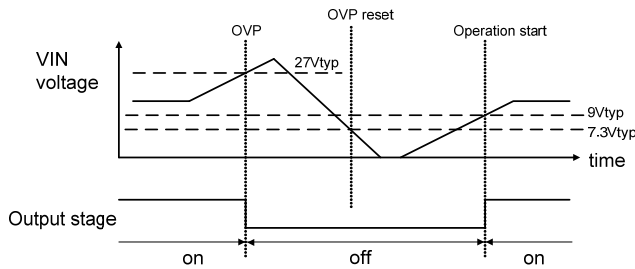

3.4 OTP(Over Temperature Protection)

The over temperature protection stops the switching operation of the IC in case the junction temperature reaches 165°C (typ.) (A). The IC starts switching operation again when the junction temperature is 135°C (typ.) (B) or lower. Please see OTP waveform chart.

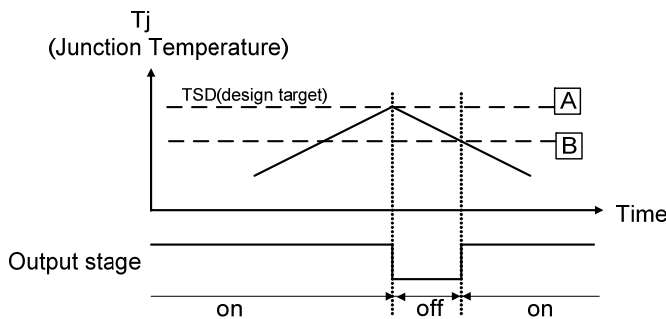

ORDERING INFORMATION

Device	Package	Shipping (Qty / Packing)
LV5011MD-AH	SOIC-10NB (Pb-Free / Halogen Free)	2500 / Tape & Reel

ON Semiconductor and the ON logo are registered trademarks of Semiconductor Components Industries, LLC (SCILLC). SCILLC owns the rights to a number of patents, trademarks, copyrights, trade secrets, and other intellectual property. A listing of SCILLC's product/patent coverage may be accessed at www.onsemi.com/site/pdf/Patent-Marking.pdf. SCILLC reserves the right to make changes without further notice to any products herein. SCILLC makes no warranty, representation or guarantee regarding the suitability of its products for any particular purpose, nor does SCILLC assume any liability arising out of the application or use of any product or circuit, and specifically disclaims any and all liability, including without limitation special, consequential or incidental damages. "Typical" parameters which may be provided in SCILLC data sheets and/or specifications can and do vary in different applications and actual performance may vary over time. All operating parameters, including "Typicals" must be validated for each customer application by customer's technical experts. SCILLC does not convey any license under its patent rights nor the rights of others. SCILLC products are not designed, intended, or authorized for use as components in systems intended for surgical implant into the body, or other applications intended to support or sustain life, or for any other application in which the failure of the SCILLC product could create a situation where personal injury or death may occur. Should Buyer purchase or use SCILLC products for any such unintended or unauthorized application, Buyer shall indemnify and hold SCILLC and its officers, employees, subsidiaries, affiliates, and distributors harmless against all claims, costs, damages, and expenses, and reasonable attorney fees arising out of, directly or indirectly, any claim of personal injury or death associated with such unintended or unauthorized use, even if such claim alleges that SCILLC was negligent regarding the design or manufacture of the part. SCILLC is an Equal Opportunity/Affirmative Action Employer. This literature is subject to all applicable copyright laws and is not for resale in any manner.