



MLG5-1600A812

MLG

MEASURING AUTOMATION LIGHT GRIDS

SICK
Sensor Intelligence.

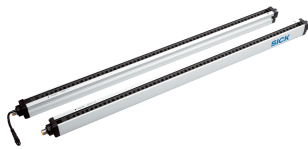

Ordering information

Type	Part no.
MLG5-1600A812	1059856

Other models and accessories → www.sick.de/MLG



Detailed technical data

Features

Technology	Sender/receiver
Minimum detectable object (MDO)	Parallel beam, 55 mm
Beam separation	50 mm
Number of beams	≥ 33
Detection height	1,600 mm
Configuration	Parameterization interface (measuring)

Performance

Maximum range	7 m ¹⁾
Minimum range	Parallel beam: ≥ 0 mm
Working range	5 m
Response time	Parallel beam ≥ 5.95 ms ²⁾

¹⁾ No reserve for environmental issue and deterioration of the diode.

²⁾ With resistive load.

Interfaces

Switching output	2 x Analog 1 x PNP
Inputs	1 x PNP
Connection type	Male connector M12, 8-pin

Mechanics/electronics

Wave length	Infrared light, 880 nm
Supply voltage V_s	DC 18 V ... 30 V
Power consumption sender	≥ 206 mA ¹⁾
Power consumption receiver	≥ 199 mA ¹⁾
Ripple	< 5 V _{pp}
Output current I_{max.}	≤ 100 mA
Output load capacitive	100 nF
Output load inductive	1 H
Initialization time	1 s
Dimensions (W x H x D)	34 mm x 1,714 mm x 29 mm

¹⁾ Without load with 24 V.

Housing material	Aluminum
Indication	7-segment display, 7-segment display
Synchronization	Cable
Enclosure rating	IP 65
Circuit protection	U _V connections, reverse polarity protected, Output Q short-circuit protected, Interference pulse suppression
Weight	≥ 4.18 kg
Front screen	PMMA

¹⁾ Without load with 24 V.

Ambient data

Protection class	III
EMC	EN 60947-5-2
Ambient temperature	Operation: -25 °C ... +55 °C Storage: -40 °C ... +70 °C
Ambient light immunity	Direct: 12,500 lx ¹⁾ Indirect: 50,000 lx
Vibration resistance	5 g, 10 Hz ... 55 Hz (IEC 68-2-6)
Shock load	10 g / IEC 68-2-29 / 16 ms

¹⁾ Sunlight.

Dimensional drawing (Dimensions in mm (inch))

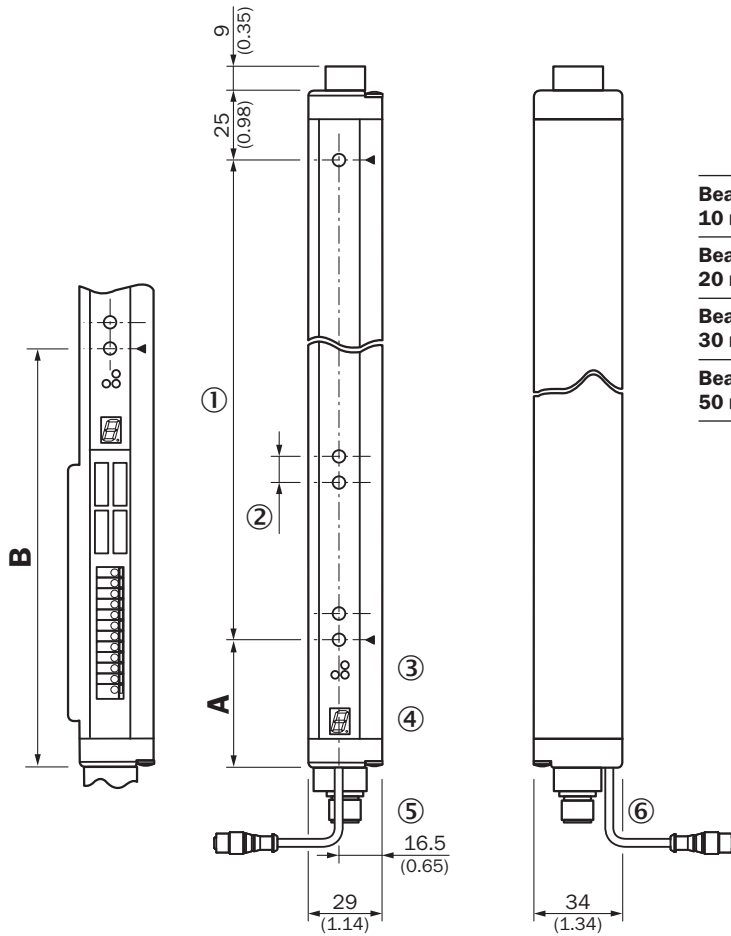

- ① Detection height (see optical performance)
- ② Beam separation (10, 20, 30, 50 mm)
- ③ Status indicator: green, yellow, red LEDs
- ④ Indicator panel, 7-segment display
- ⑤ Terminals: M16 cable entry/connector M12, 12-pin
- ⑥ Configuration connector M8, 4-pin

	A	B
	Distance: MLG edge - first beam	
Beam separation MLG1 10 mm	49 (1.93)	160 (6.30)
Beam separation MLG2 20 mm	49 (1.93) ¹⁾ 59 (2.32) ²⁾	170 (6.69)
Beam separation MLG3 30 mm	69 (2.72)	180 (7.09)
Beam separation MLG5 50 mm	89 (3.50)	200 (7.87)

¹⁾ With even number of beams.
²⁾ With odd number of beams.

Adjustments



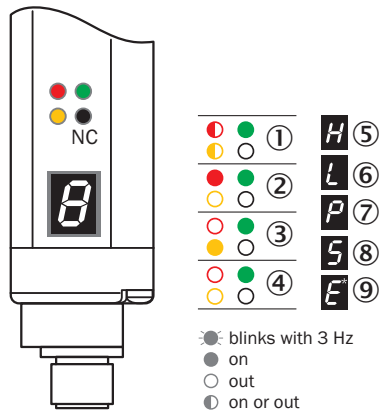

LED indicator







- ① Supply voltage
- ② Device error
- ③ No object in the light path
- ④ Contamination control
- ⑤ Blocked Beams Hold (BBH)
- ⑥ Activated teach-in procedure
- ⑦ ParamMode is active
- ⑧ Standby
- ⑨ Error: E1 = sync. error; E2 = less receiver signal; E9 = defect

Recommended accessories

Other models and accessories → www.sick.de/MLG

	Brief description	Type	Part no.
Mounting brackets and mounting plates			
	Side mounting with T-nuts, 4 pieces, mounting hardware included	BEF-NUT-MLG	2023696
	Metal mounting bracket, compact, steel, zinc coated, Set, consisting of 4 pieces, without mounting hardware	BEF-WK-XLG	2029100
Terminal and alignment brackets			
	4 pieces, Mounting kit 1, rotatable, swivel mount, plastic	BEF-2SMKEAKU4	2019649
Adapters and distributors			
	Male connector M12, 8-pin, straight, to 1 x female connector M12, 8-pin, straight and 1 x female connector M12, 8-pin, straight	SBO-02F12-SM	6029306
Plug connectors and cables			

	Brief description	Type	Part no.
	Head A: female connector, M12, 8-pin, straight Head B: cable Cable: PVC, shielded, 2 m	DOL-1208-G02MA	6020633
	Head A: female connector, M12, 8-pin, straight Head B: cable Cable: PVC, shielded, 5 m	DOL-1208-G05MA	6020993
	Head A: female connector, M12, 8-pin, straight Head B: cable Cable: PVC, shielded, 10 m	DOL-1208-G10MA	6022152
	Head A: female connector, M12, 8-pin, angled Head B: cable Cable: PVC, shielded, 2 m	DOL-1208-W02MA	6020992
	Head A: female connector, M12, 8-pin, angled Head B: cable Cable: PVC, shielded, 5 m	DOL-1208-W05MA	6021033
	Head A: female connector, M8, 4-pin, straight Head B: female connector, D-Sub, 9-pin, straight Cable: unshielded, 2 m Rectangular plug-in system, parameterization cable	DSL-8D04-G02M	2023695
	Head A: female connector, M12, 8-pin, straight Head B: male connector, M12, 8-pin, straight Cable: drag chain use, PUR, halogen-free, shielded, 2 m	DSL-1208-G02MAC	6030121
	Head A: female connector, M12, 8-pin, straight Head B: male connector, M12, 8-pin, straight Cable: drag chain use, PUR, halogen-free, shielded, 5 m	DSL-1208-G05MAC	6032325
	Head A: female connector, M12, 8-pin, straight Head B: male connector, M12, 8-pin, straight Cable: drag chain use, PUR, halogen-free, shielded, 10 m	DSL-1208-G10MAC	6034901

SICK AT A GLANCE

SICK is one of the leading manufacturers of intelligent sensors and sensor solutions for industrial applications. A unique range of products and services creates the perfect basis for controlling processes securely and efficiently, protecting individuals from accidents and preventing damage to the environment.

We have extensive experience in a wide range of industries and understand their processes and requirements. With intelligent sensors, we can deliver exactly what our customers need. In application centers in Europe, Asia and North America, system solutions are tested and optimized in accordance with customer specifications. All this makes us a reliable supplier and development partner.

Comprehensive services complete our offering: SICK LifeTime Services provide support throughout the machine life cycle and ensure safety and productivity.

For us, that is “Sensor Intelligence.”

WORLDWIDE PRESENCE:

Contacts and other locations –www.sick.com