

P-Channel MOSFET

2SJ130S

■ Features

- $V_{DS} = -300V$
- $I_D = -1 A$ ($V_{GS} = -10V$)
- $R_{DS(ON)} < 8.5 \Omega$ ($V_{GS} = -10V$)
- High speed switching
- Low drive current

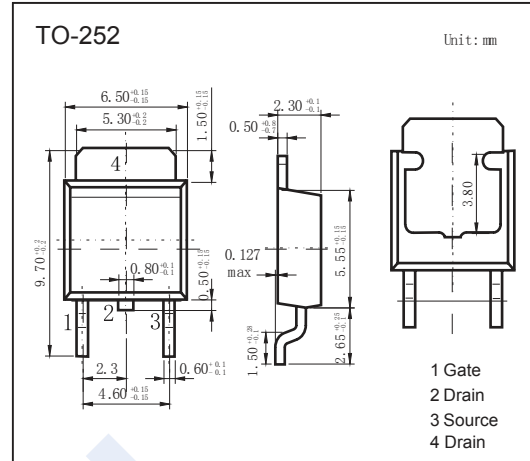
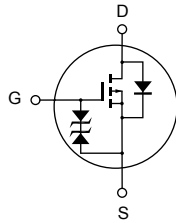

■ Absolute Maximum Ratings $T_a = 25^\circ C$

Parameter	Symbol	Rating	Unit
Drain-Source Voltage	V_{DS}	-300	V
Gate-Source Voltage	V_{GS}	± 20	
Continuous Drain Current	I_D	-1	A
Pulsed Drain Current	I_{DM}	-2	
Body to Drain Diode Reverse Drain Current	I_{DR}	-1	
Power Dissipation $T_c = 25^\circ C$	P_D	20	W
Junction Temperature	T_J	150	$^\circ C$
Junction Storage Temperature Range	T_{stg}	-55 to 150	

■ Electrical Characteristics $T_a = 25^\circ C$

Parameter	Symbol	Test Conditions	Min	Typ	Max	Unit
Drain-Source Breakdown Voltage	V_{DSS}	$I_D = -10 \text{ mA}, V_{GS} = 0V$	-300			V
Gate to Source Breakdown Voltage	V_{GSS}	$I_G = \pm 100 \mu A, V_{DS} = 0V$	± 20			
Zero Gate Voltage Drain Current	I_{DSS}	$V_{DS} = -240V, V_{GS} = 0V$			-100	μA
Gate-Body leakage current	I_{GSS}	$V_{DS} = 0V, V_{GS} = \pm 16V$			± 10	μA
Gate to Source Cutoff Voltage	$V_{GS(off)}$	$V_{GS} = -10V, I_D = -1mA$	-2		-4	V
Static Drain-Source On-Resistance	$R_{DS(on)}$	$V_{GS} = -10V, I_D = -0.5A$			8.5	Ω
Forward Transconductance	g_{FS}	$V_{DS} = -20V, I_D = -0.5A$	0.25	0.4		S
Input Capacitance	C_{iss}	$V_{GS} = 0V, V_{DS} = -10V, f = 1MHz$		235		pF
Output Capacitance	C_{oss}			65		
Reverse Transfer Capacitance	C_{rss}			16		
Turn-On DelayTime	$t_{d(on)}$	$V_{GS} = -10V, I_D = -0.5A, R_L = 60 \Omega$		10		ns
Turn-On Rise Time	t_r			25		
Turn-Off DelayTime	$t_{d(off)}$			35		
Turn-Off Fall Time	t_f			45		
Body Diode Reverse Recovery Time	t_{rr}	$I_F = -1A, V_{GS} = 0, di/dt = 50A/\mu s$		200		
Diode Forward Voltage	V_{SD}	$I_S = -1A, V_{GS} = 0V$		-0.9		V

P-Channel MOSFET 2SJ130S

■ Typical Characteristics

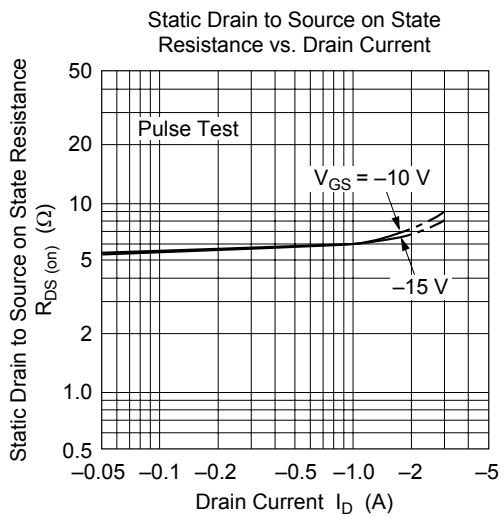
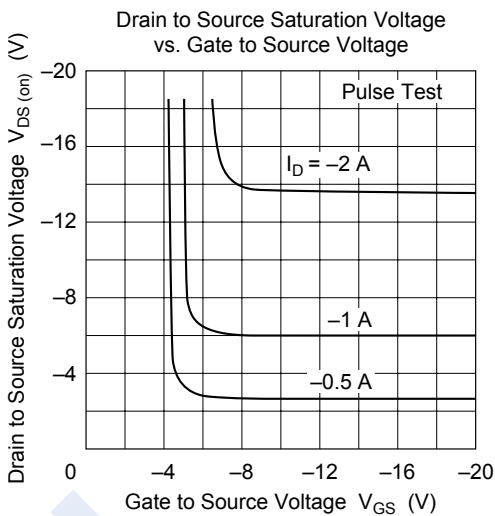
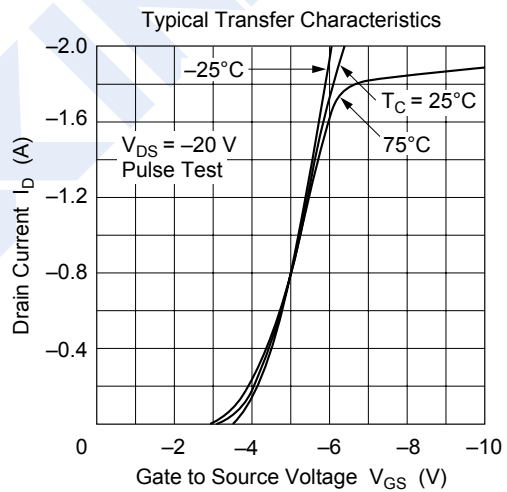
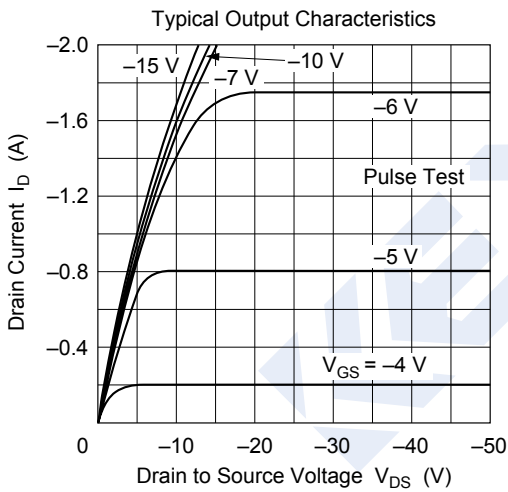
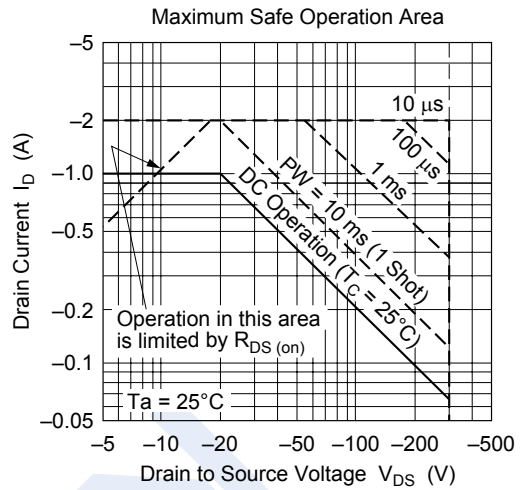
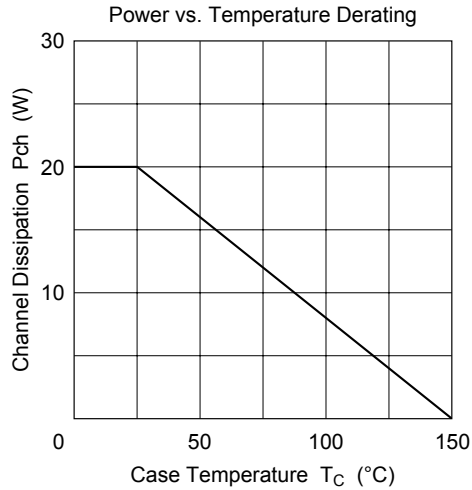

P-Channel MOSFET 2SJ130S

■ Typical Characteristics

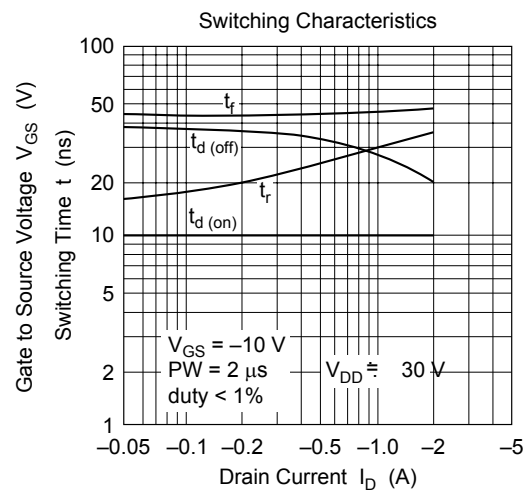
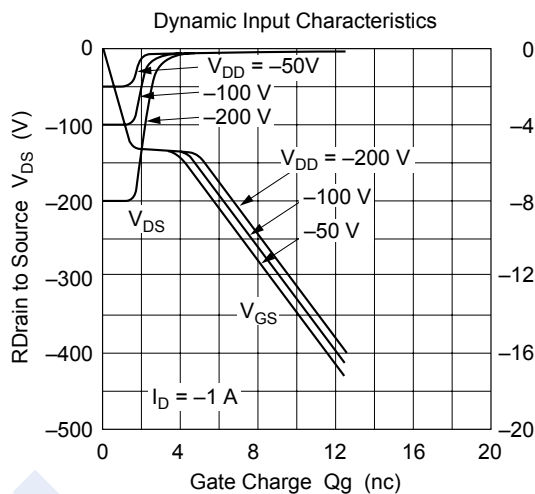
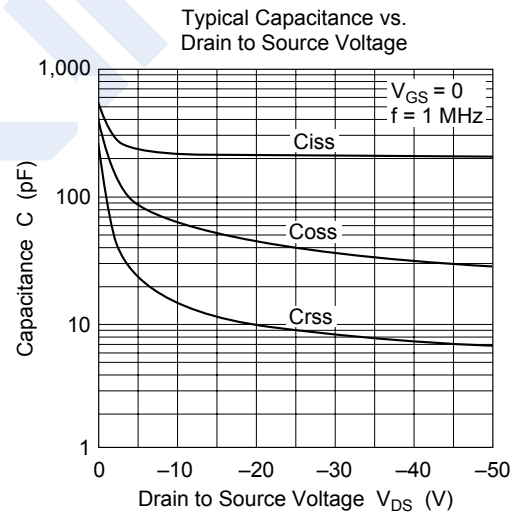
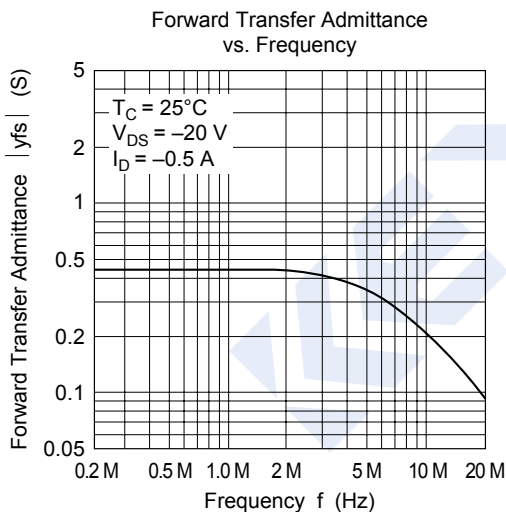
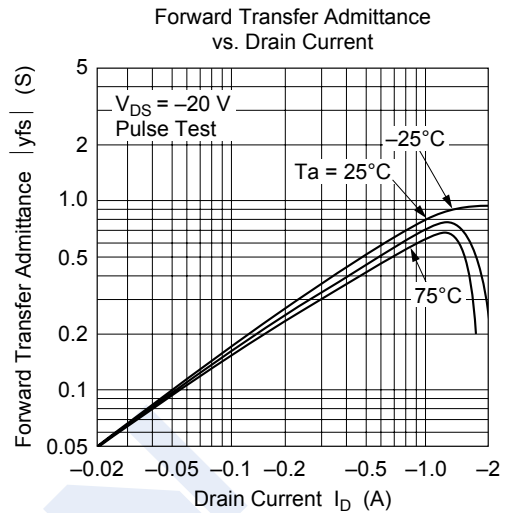
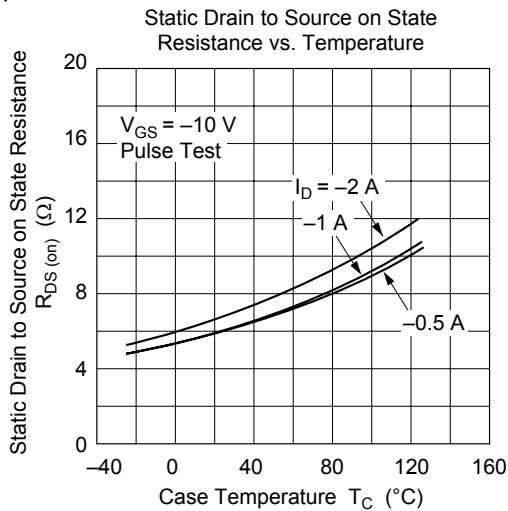

P-Channel MOSFET 2SJ130S

■ Typical Characteristics

