

P-Channel Enhancement Mode MOSFET

Feature

- -30V/-4.2A, $R_{DS(ON)} = 55m\Omega(MAX) @V_{GS} = -10V$.
 $R_{DS(ON)} = 70m\Omega(MAX) @V_{GS} = -4.5V$.
 $R_{DS(ON)} = 120m\Omega(MAX) @V_{GS} = -2.5V$.
- Super High dense cell design for extremely low $R_{DS(ON)}$
- Reliable and Rugged
- SOT-23 for Surface Mount Package



SOT-23

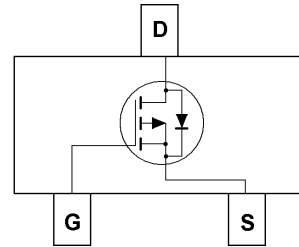

Applications

- Power Management
 Portable Equipment and Battery Powered Systems.

Absolute Maximum Ratings $T_A = 25^\circ C$ Unless Otherwise noted

Parameter	Symbol	Limit	Units
Drain-Source Voltage	V_{DS}	-30	V
Gate-Source Voltage	V_{GS}	± 12	V
Drain Current-Continuous	I_D	-4.2	A

Electrical Characteristics $T_A = 25^\circ C$ Unless Otherwise noted

Parameter	Symbol	Test Conditions	Min	Typ.	Max	Units
Off Characteristics						
Drain to Source Breakdown Voltage	BVDSS	$V_{GS} = 0V, I_D = -250\mu A$	-30	-	-	V
Zero-Gate Voltage Drain Current	IDSS	$V_{DS} = -24V, V_{GS} = 0V$	-	-	-1	μA
Gate Body Leakage Current, Forward	IGSSF	$V_{GS} = 12V, V_{DS} = 0V$	-	-	100	nA
Gate Body Leakage Current, Reverse	IGSSR	$V_{GS} = -12V, V_{DS} = 0V$	-	-	-100	nA
On Characteristics						
Gate Threshold Voltage	$V_{GS(th)}$	$V_{GS} = V_{DS}, I_D = -250\mu A$	-0.7	-	-1.3	V
Static Drain-source On-Resistance	RDS(ON)	$V_{GS} = -10V, I_D = -4.2A$	-	50	55	$m\Omega$
		$V_{GS} = -4.5V, I_D = -4.0A$	-	60	70	$m\Omega$
		$V_{GS} = -2.5V, I_D = -1.0A$	-	80	120	$m\Omega$
Drain-Source Diode Characteristics and Maximum Ratings						
Drain-Source Diode Forward Voltage	VSD	$V_{GS} = 0V, I_S = -1.0A$			-1.0	V

Typical Characteristics

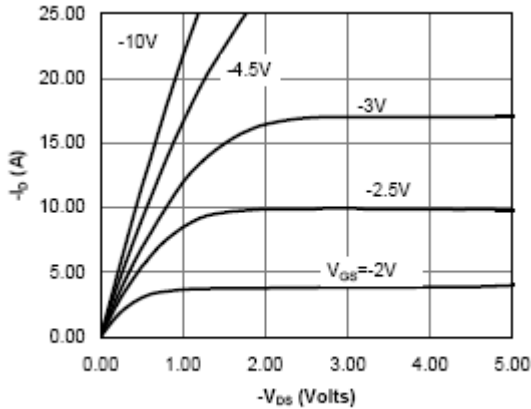

Fig 1: On-Region Characteristics

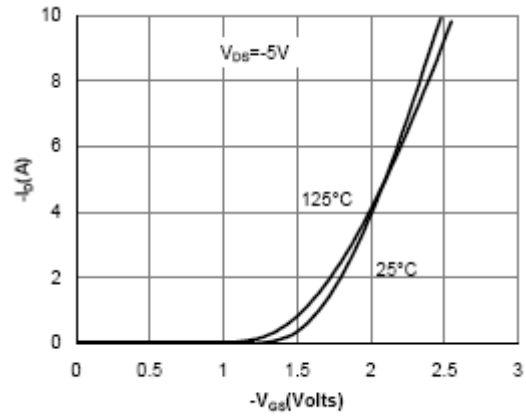

Figure 2: Transfer Characteristics

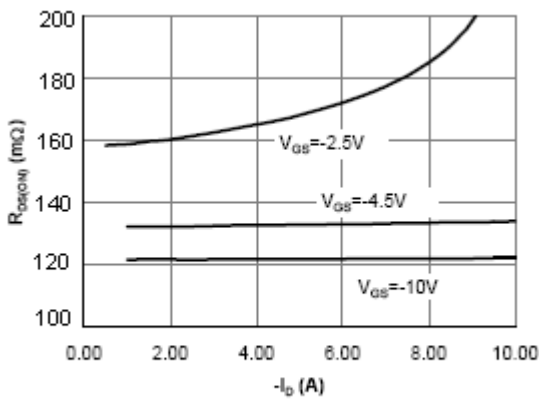

Figure 3: On-Resistance vs. Drain Current and Gate Voltage

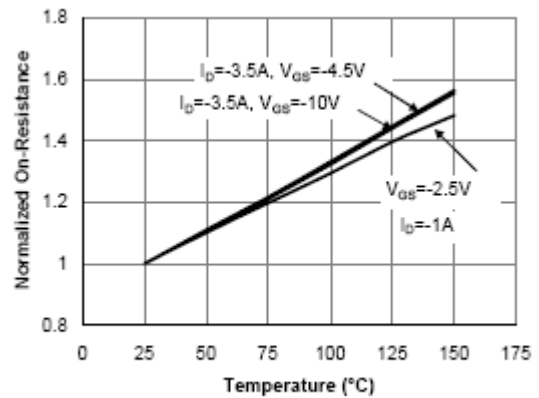

Figure 4: On-Resistance vs. Junction Temperature

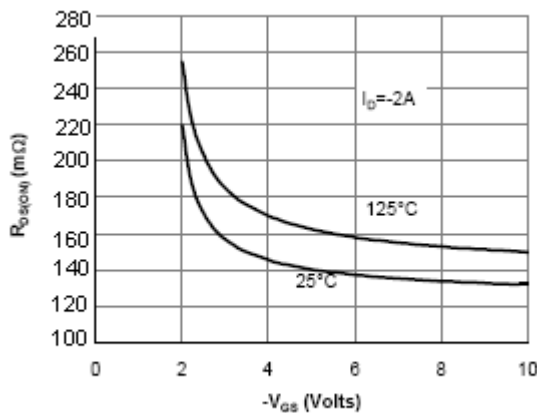

Figure 5: On-Resistance vs. Gate-Source Voltage

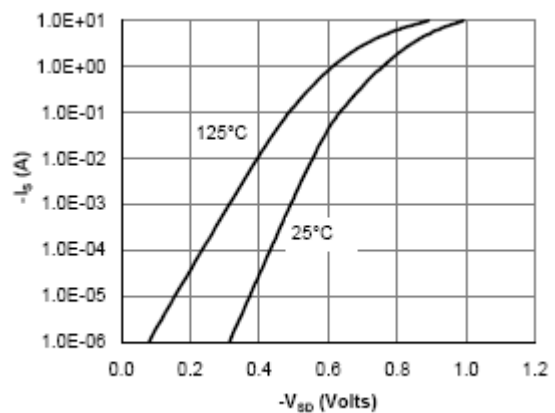
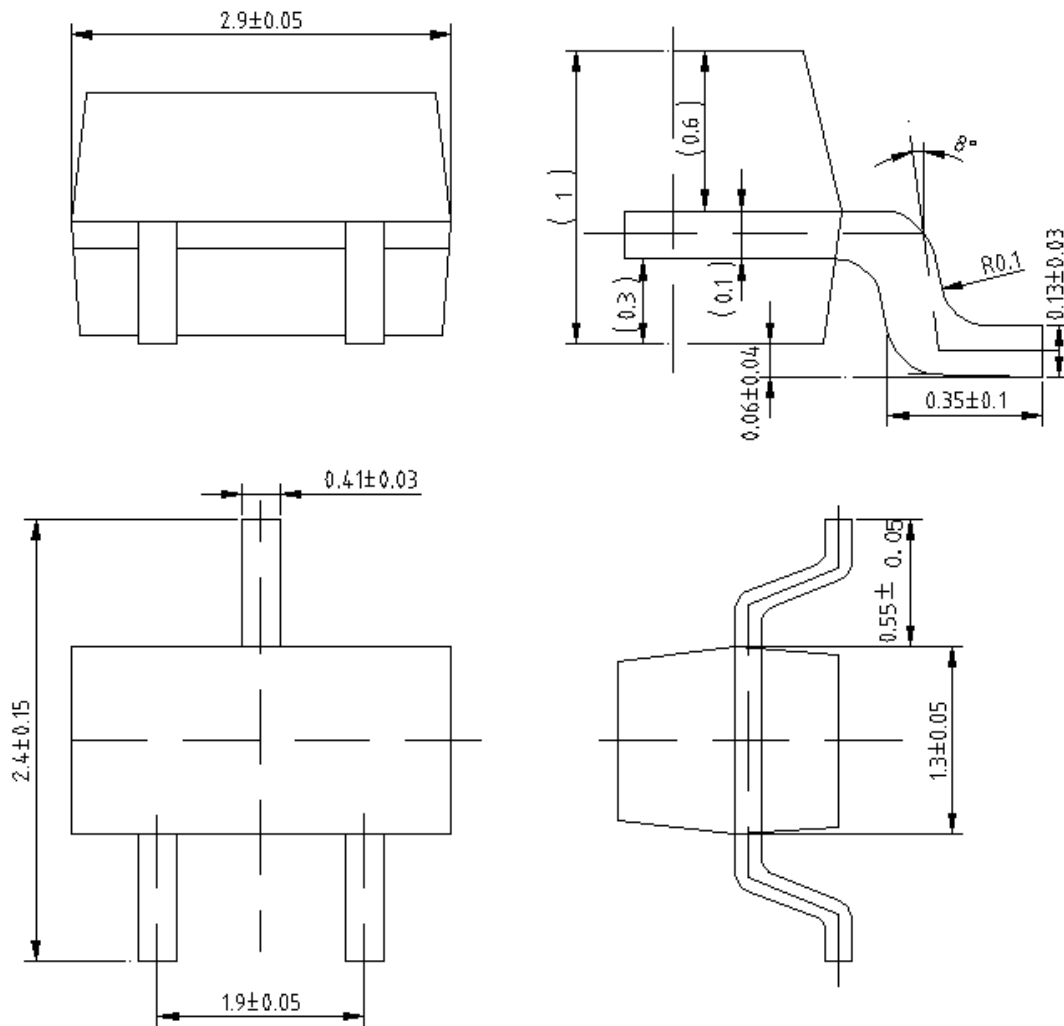

Figure 6: Body-Diode Characteristics

Package Outline Dimensions (UNIT: mm)

SOT-23



SOT-23 Carrier Tape

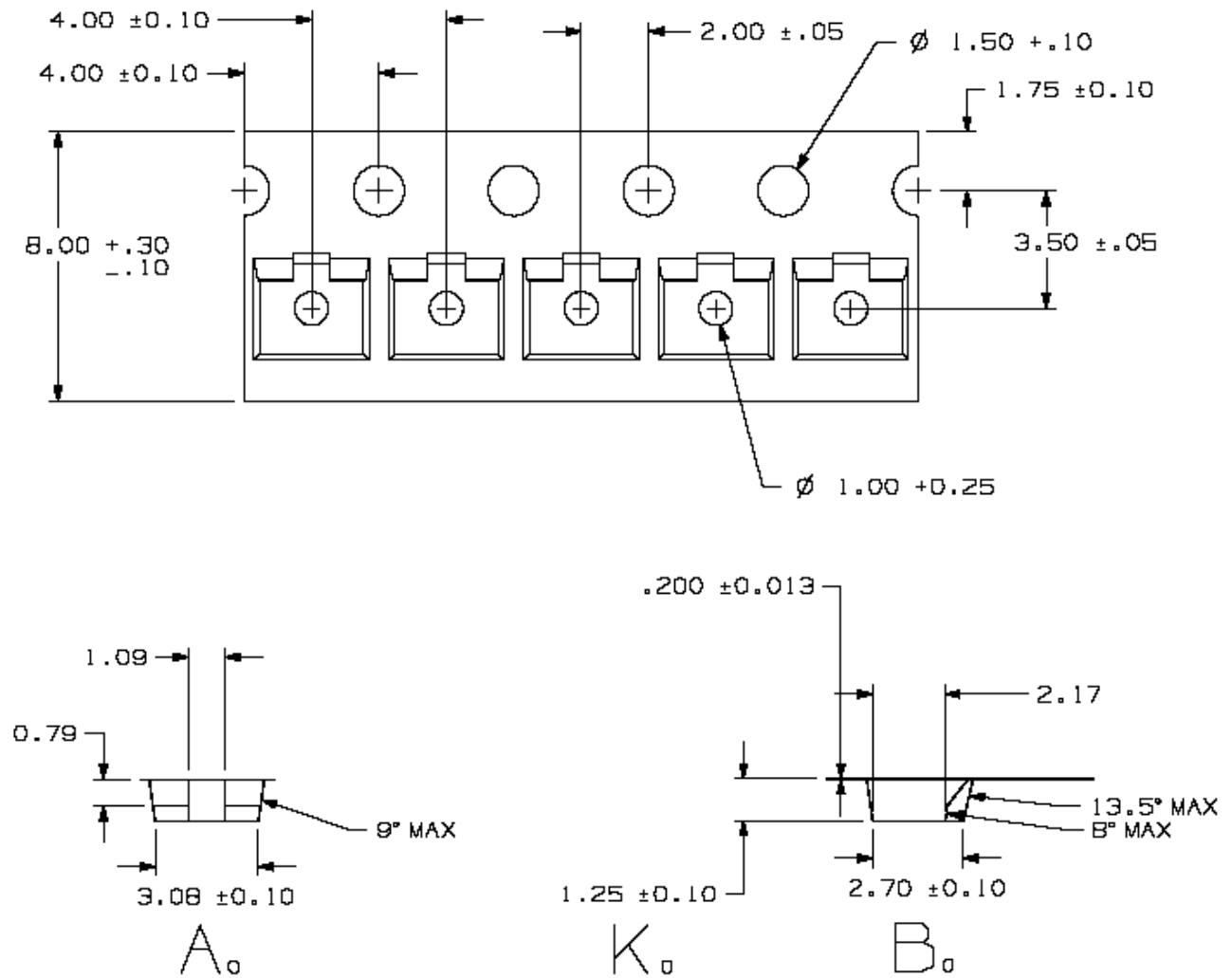

SOT-23 Carrier Reel

