

Single N-channel MOSFET

ELM53402CA-S

■ General description

ELM53402CA-S uses advanced trench technology to provide excellent $R_{ds(on)}$, low gate charge and low gate resistance.

■ Features

- $V_{ds}=20V$
- $I_d=3.6A$
- $R_{ds(on)} < 70m\Omega$ ($V_{gs}=4.5V$)
- $R_{ds(on)} < 80m\Omega$ ($V_{gs}=2.5V$)
- $R_{ds(on)} < 100m\Omega$ ($V_{gs}=1.8V$)

■ Maximum absolute ratings

$T_a=25^\circ C$. Unless otherwise noted.

Parameter	Symbol	Limit	Unit
Drain-source voltage	V_{ds}	20	V
Gate-source voltage	V_{gs}	± 12	V
Continuous drain current($T_j=150^\circ C$)	I_d	$T_a=25^\circ C$	3.6
		$T_a=70^\circ C$	2.0
Pulsed drain current	I_{dm}	10	A
Power dissipation	P_d	$T_c=25^\circ C$	1.25
		$T_c=70^\circ C$	0.80
Junction and storage temperature range	T_j, T_{stg}	- 55 to 150	$^\circ C$

■ Thermal characteristics

Parameter	Symbol	Typ.	Max.	Unit
Maximum junction-to-ambient	$R\theta_{ja}$		120	$^\circ C/W$

■ Pin configuration

SOT-23(TOP VIEW)

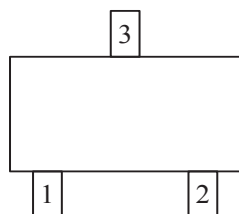

Pin No.	Pin name
1	GATE
2	SOURCE
3	DRAIN

■ Circuit

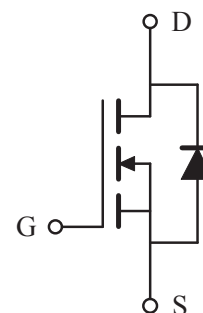

Single N-channel MOSFET

ELM53402CA-S

■ Electrical characteristics

Ta=25°C. Unless otherwise noted.

Parameter	Symbol	Condition	Min.	Typ.	Max.	Unit
STATIC PARAMETERS						
Drain-source breakdown voltage	BVdss	Id=250μA, Vgs=0V	20			V
Zero gate voltage drain current	Idss	Vds=16V, Vgs=0V Ta=85°C			1	μA
					10	
Gate-body leakage current	Igss	Vds=0V, Vgs=±12V			±100	nA
Gate threshold voltage	Vgs(th)	Vds=Vgs, Id=250μA	0.3		0.8	V
On state drain current	Id(on)	Vgs=4.5V, Vds=5V	6			A
		Vgs=2.5V, Vds=5V	4			
Static drain-source on-resistance	Rds(on)	Vgs=4.5V, Id=2.4A		56	70	mΩ
		Vgs=2.5V, Id=2.0A		66	80	
		Vgs=1.8V, Id=1.8A		86	100	
Forward transconductance	Gfs	Vds=5V, Id=3.6A		10		S
Diode forward voltage	Vsd	Is=1.6A, Vgs=0V		0.85	1.20	V
Max. body-diode continuous current	Is				1.6	A
DYNAMIC PARAMETERS						
Input capacitance	Ciss			340		pF
Output capacitance	Coss	Vgs=0V, Vds=10V, f=1MHz		115		pF
Reverse transfer capacitance	Crss			33		pF
SWITCHING PARAMETERS						
Total gate charge	Qg	Vgs=4.5V, Vds=10V Id=3.6A		4.2	5.0	nC
Gate-source charge	Qgs			0.6		nC
Gate-drain charge	Qgd			0.4		nC
Turn-on delay time	td(on)	Vgs=4.5V, Vds=10V RL=2.8Ω, Id=3.6A		8	15	ns
Turn-on rise time	tr			8	15	ns
Turn-off delay time	td(off)	Rgen=1Ω		25	40	ns
Turn-off fall time	tf			8	15	ns

Single N-channel MOSFET

ELM53402CA-S

■ Typical electrical and thermal characteristics

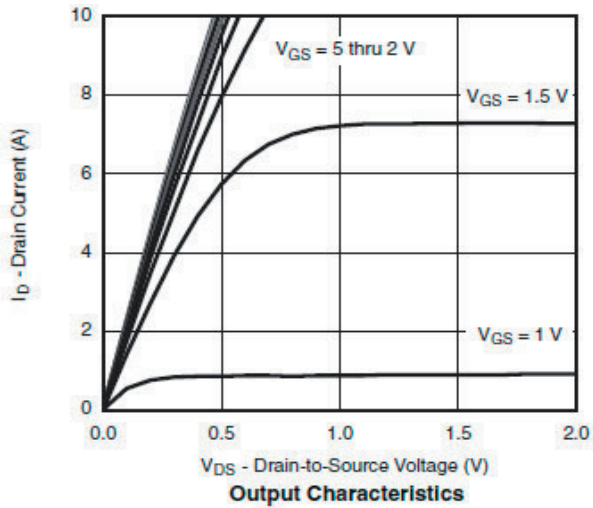

Output Characteristics

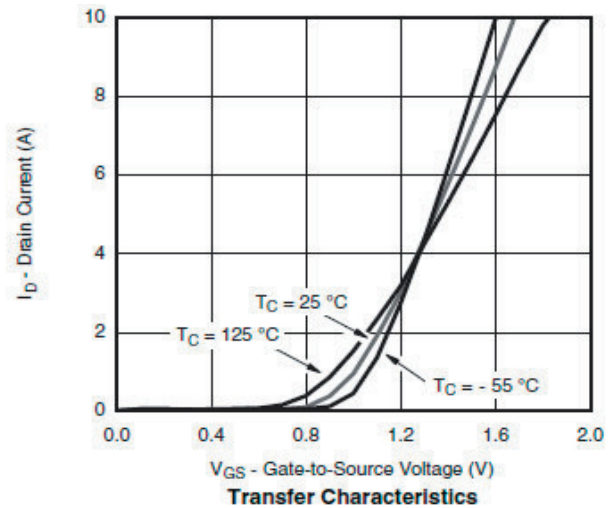

Transfer Characteristics

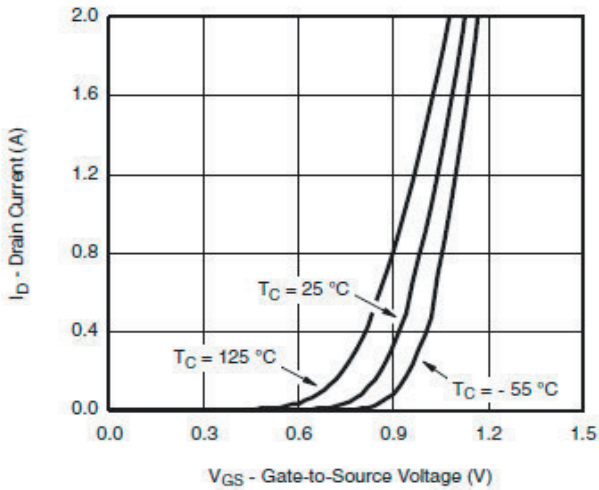

Transfer Characteristics

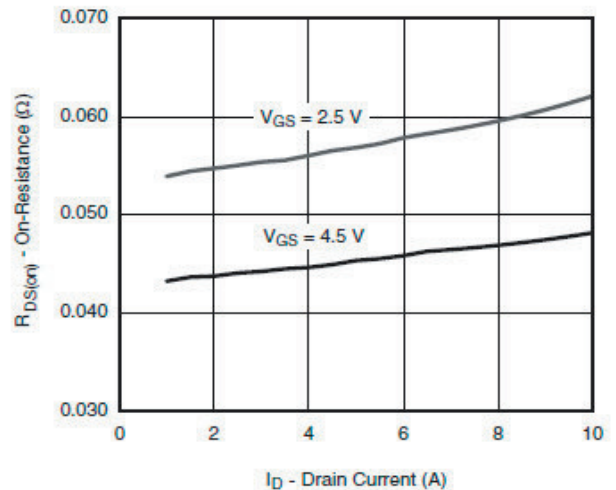

On-Resistance vs. Drain Current

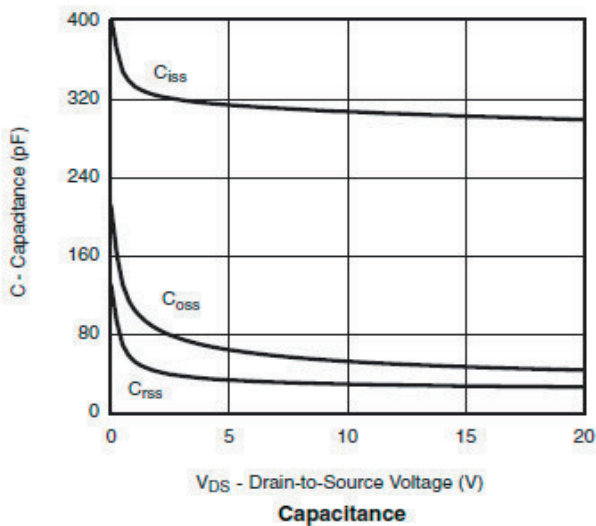

Capacitance

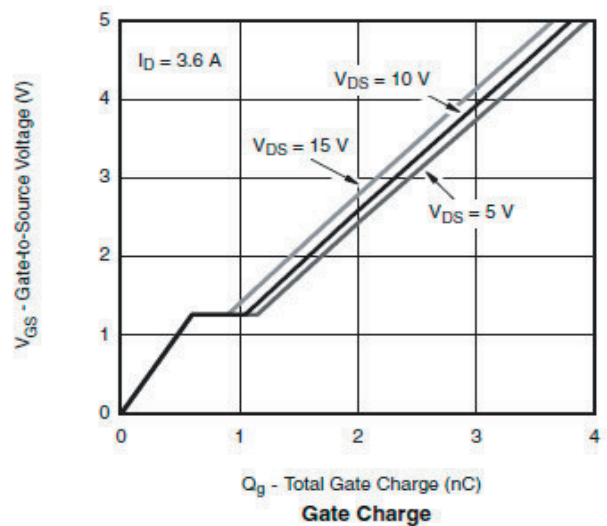

Gate Charge

Single N-channel MOSFET

ELM53402CA-S

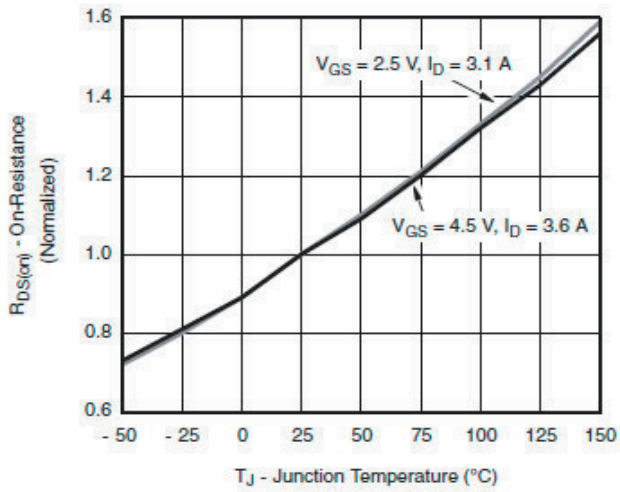

On-Resistance vs. Junction Temperature

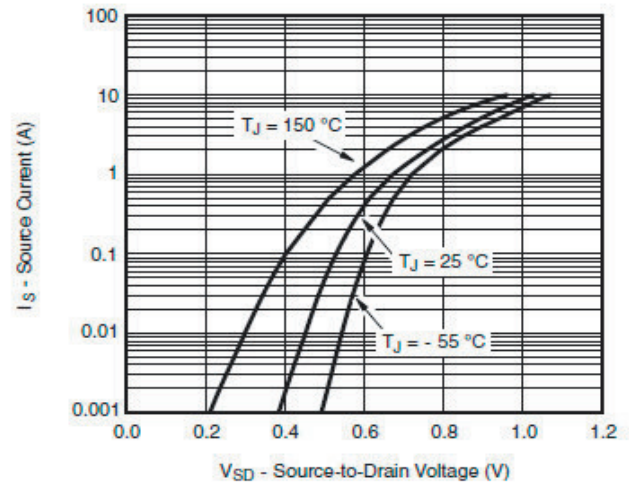

Source-Drain Diode Forward Voltage

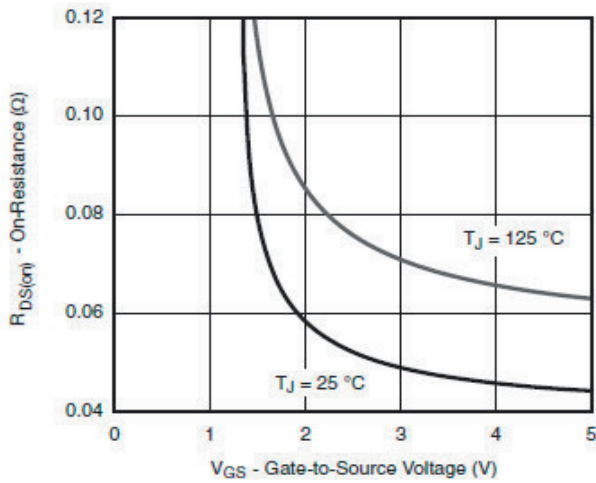

On-Resistance vs. Gate-to-Source Voltage

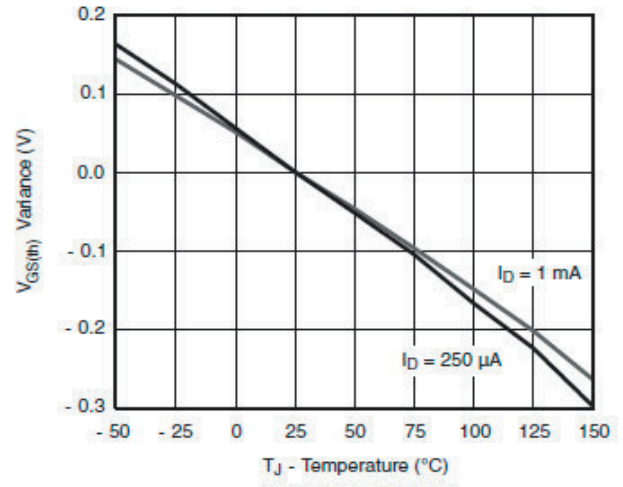

Threshold Voltage

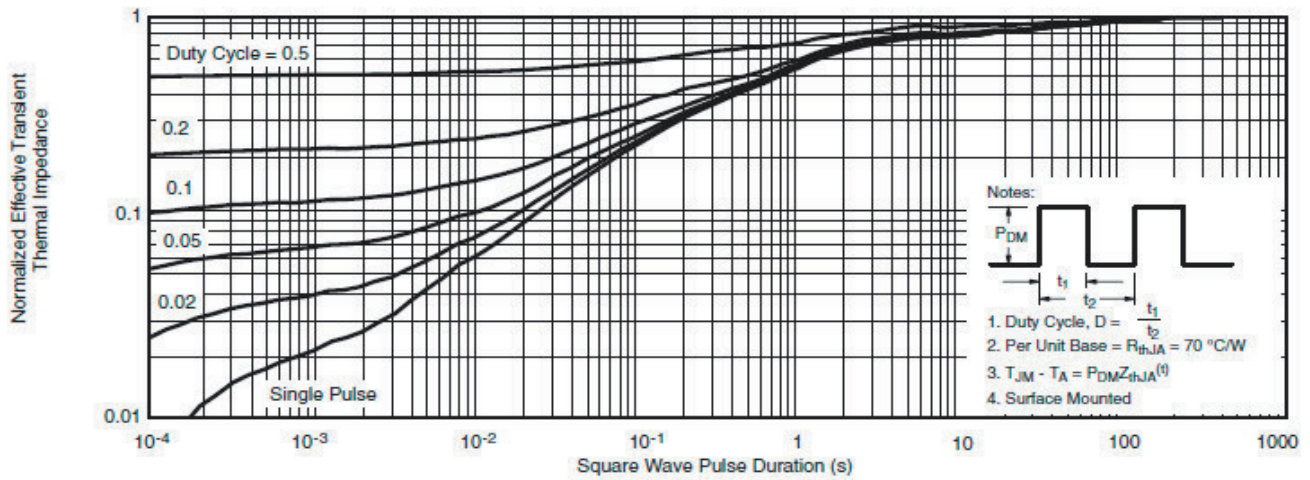

Normalized Thermal Transient Impedance, Junction-to-Ambient

Single N-channel MOSFET

ELM53402CA-S

■ Test circuit and waveform

Gate Charge Test Circuit & Waveform

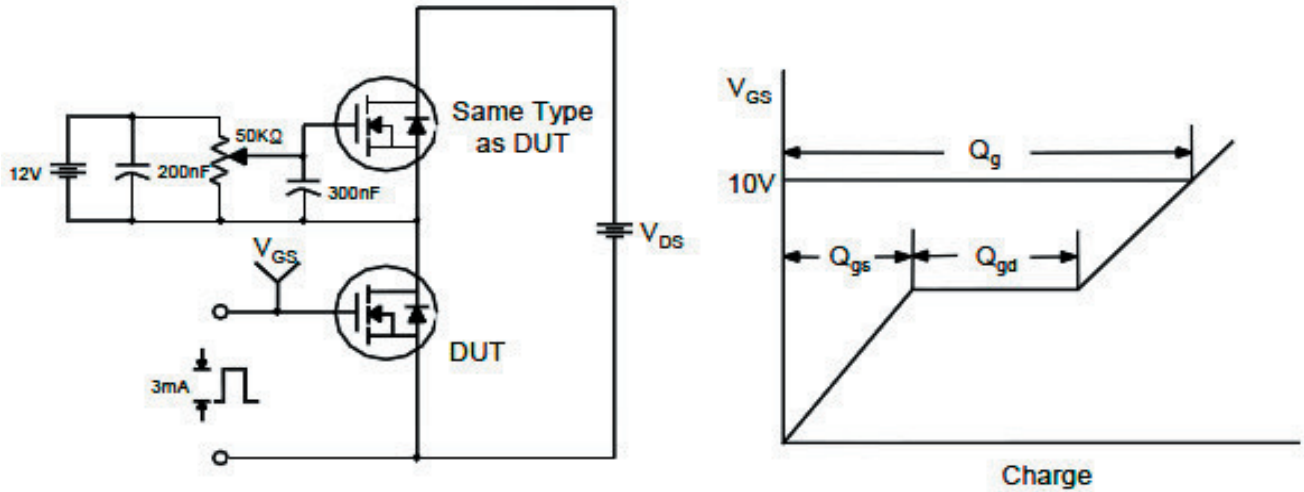

Resistive Switching Test Circuit & Waveforms

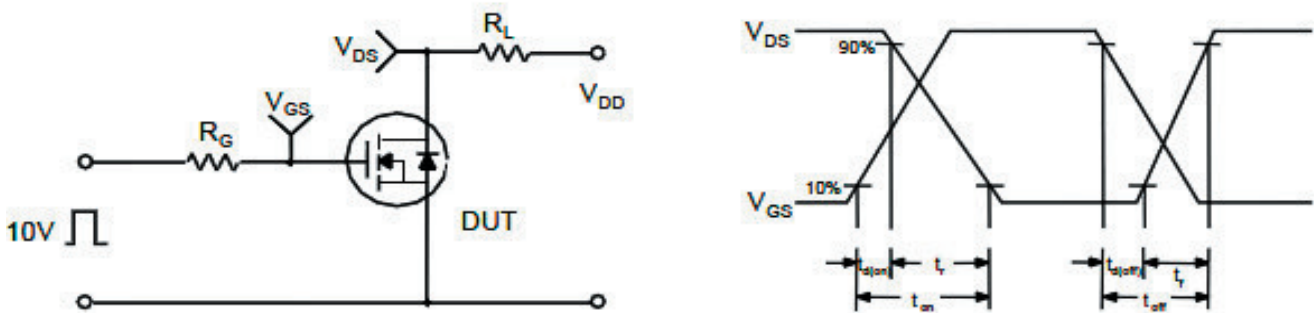

Unclamped Inductive Switching Test Circuit & Waveforms

