

# HFD1N60F / HFU1N60F

## 600V N-Channel MOSFET

### FEATURES

- ❑ Originative New Design
- ❑ Superior Avalanche Rugged Technology
- ❑ Robust Gate Oxide Technology
- ❑ Very Low Intrinsic Capacitances
- ❑ Excellent Switching Characteristics
- ❑ Unrivalled Gate Charge : 3.7 nC (Typ.)
- ❑ Extended Safe Operating Area
- ❑ Lower  $R_{DS(ON)}$  : 6.5  $\Omega$  (Typ.) @ $V_{GS}=10V$
- ❑ 100% Avalanche Tested

$$BV_{DSS} = 600 \text{ V}$$

$$R_{DS(on) \text{ typ}} = 6.5 \ \Omega$$

$$I_D = 1 \text{ A}$$

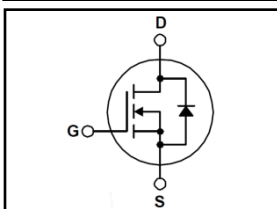
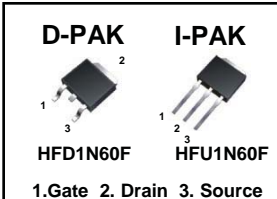

### Absolute Maximum Ratings $T_C=25^\circ\text{C}$ unless otherwise specified

| Symbol         | Parameter   | Value       | Units               |
|----------------|---|-------------|---------------------|
| $V_{DSS}$      | Drain-Source Voltage  | 600         | V                   |
| $I_D$          | Drain Current – Continuous ( $T_C = 25^\circ\text{C}$ )                       | 1.0         | A                   |
|                | Drain Current – Continuous ( $T_C = 100^\circ\text{C}$ )                      | 0.6         | A                   |
| $I_{DM}$       | Drain Current – Pulsed (Note 1)   | 4.0         | A                   |
| $V_{GS}$       | Gate-Source Voltage   | $\pm 30$    | V                   |
| $E_{AS}$       | Single Pulsed Avalanche Energy (Note 2)                                       | 33          | mJ                  |
| $I_{AR}$       | Avalanche Current (Note 1)  | 1.0         | A                   |
| $E_{AR}$       | Repetitive Avalanche Energy (Note 1)  | 2.8         | mJ                  |
| $P_D$          | Power Dissipation ( $T_A = 25^\circ\text{C}$ )*                               | 2.5         | W                   |
|                | Power Dissipation ( $T_C = 25^\circ\text{C}$ )                                | 28          | W                   |
|                | - Derate above $25^\circ\text{C}$   | 0.22        | W/ $^\circ\text{C}$ |
| $T_J, T_{STG}$ | Operating and Storage Temperature Range                                       | -55 to +150 | $^\circ\text{C}$    |
| $T_L$          | Maximum lead temperature for soldering purposes, 1/8" from case for 5 seconds | 300         | $^\circ\text{C}$    |

### Thermal Resistance Characteristics

| Symbol          | Parameter            | Typ. | Max. | Units              |
|-----------------|----------------------|------|------|--------------------|
| $R_{\theta JC}$ | Junction-to-Case     | --   | 4.53 | $^\circ\text{C/W}$ |
| $R_{\theta JA}$ | Junction-to-Ambient* | --   | 50   |                    |
| $R_{\theta JA}$ | Junction-to-Ambient  | --   | 110  |                    |

\* When mounted on the minimum pad size recommended (PCB Mount)

**Electrical Characteristics**  $T_J=25\text{ }^\circ\text{C}$  unless otherwise specified

| Symbol  | Parameter                                     | Test Conditions   | Min | Typ | Max       | Units         |
|---|---|---|-----|-----|-----------|---------------|
| <b>On Characteristics</b>                                     |   |   |     |     |           |               |
| $V_{GS}$  | Gate Threshold Voltage                        | $V_{DS} = V_{GS}, I_D = 250\ \mu\text{A}$   | 2.0 | --  | 4.0       | V             |
| $R_{DS(ON)}$  | Static Drain-Source On-Resistance             | $V_{GS} = 10\ \text{V}, I_D = 0.5\ \text{A}$  | --  | 6.5 | 8         | $\Omega$      |
| <b>Off Characteristics</b>                                    |   |   |     |     |           |               |
| $BV_{DSS}$  | Drain-Source Breakdown Voltage                | $V_{GS} = 0\ \text{V}, I_D = 250\ \mu\text{A}$  | 600 | --  | --        | V             |
| $I_{DSS}$   | Zero Gate Voltage Drain Current               | $V_{DS} = 600\ \text{V}, V_{GS} = 0\ \text{V}$  | --  | --  | 10        | $\mu\text{A}$ |
|   |   | $V_{DS} = 480\ \text{V}, T_C = 125\text{ }^\circ\text{C}$                                     | --  | --  | 100       | $\mu\text{A}$ |
| $I_{GSS}$   | Gate-Body Leakage Current                     | $V_{GS} = \pm 30\ \text{V}, V_{DS} = 0\ \text{V}$   | --  | --  | $\pm 100$ | nA            |
| <b>Dynamic Characteristics</b>                                |   |   |     |     |           |               |
| $C_{iss}$   | Input Capacitance                             | $V_{DS} = 25\ \text{V}, V_{GS} = 0\ \text{V},$<br>$f = 1.0\ \text{MHz}$                       | --  | 160 | --        | pF            |
| $C_{oss}$   | Output Capacitance                            |   | --  | 26  | --        | pF            |
| $C_{rss}$   | Reverse Transfer Capacitance                  |   | --  | 6.5 | --        | pF            |
| <b>Switching Characteristics</b>                              |   |   |     |     |           |               |
| $t_{d(on)}$   | Turn-On Time                                  | $V_{DS} = 300\ \text{V}, I_D = 1.0\ \text{A},$<br>$R_G = 25\ \Omega$<br><br>(Note 4,5)        | --  | 13  | --        | ns            |
| $t_r$   | Turn-On Rise Time                             |   | --  | 17  | --        | ns            |
| $t_{d(off)}$  | Turn-Off Delay Time                           |   | --  | 19  | --        | ns            |
| $t_f$   | Turn-Off Fall Time                            |   | --  | 22  | --        | ns            |
| $Q_g$   | Total Gate Charge                             | $V_{DS} = 480\ \text{V}, I_D = 1.0\ \text{A},$<br>$V_{GS} = 10\ \text{V}$<br><br>(Note 4,5)   | --  | 3.7 | --        | nC            |
| $Q_{gs}$  | Gate-Source Charge                            |   | --  | 0.9 | --        | nC            |
| $Q_{gd}$  | Gate-Drain Charge                             |   | --  | 1.3 | --        | nC            |
| <b>Source-Drain Diode Maximum Ratings and Characteristics</b> |   |   |     |     |           |               |
| $I_S$   | Continuous Source-Drain Diode Forward Current |   | --  | --  | 1.0       | A             |
| $I_{SM}$  | Pulsed Source-Drain Diode Forward Current     |   | --  | --  | 4.0       |               |
| $V_{SD}$  | Source-Drain Diode Forward Voltage            | $I_S = 1.0\ \text{A}, V_{GS} = 0\ \text{V}$   | --  | --  | 1.3       | V             |
| $t_{rr}$  | Reverse Recovery Time                         | $I_S = 1.0\ \text{A}, V_{GS} = 0\ \text{V}$<br>$di_F/dt = 100\ \text{A}/\mu\text{s}$ (Note 4) | --  | 181 | --        | ns            |
| $Q_{rr}$  | Reverse Recovery Charge                       |   | --  | 0.5 | --        | $\mu\text{C}$ |

**Notes ;**

1. Repetitive Rating : Pulse width limited by maximum junction temperature
2.  $L=59\text{mH}, I_{AS}=1.0\text{A}, V_{DD}=50\text{V}, R_G=25\Omega,$  Starting  $T_J=25^\circ\text{C}$
3.  $I_{SD}\leq 1.0\text{A}, di/dt\leq 200\text{A}/\mu\text{s}, V_{DD}\leq BV_{DSS},$  Starting  $T_J=25\text{ }^\circ\text{C}$
4. Pulse Test : Pulse Width  $\leq 300\mu\text{s},$  Duty Cycle  $\leq 2\%$
5. Essentially Independent of Operating Temperature

# Typical Characteristics

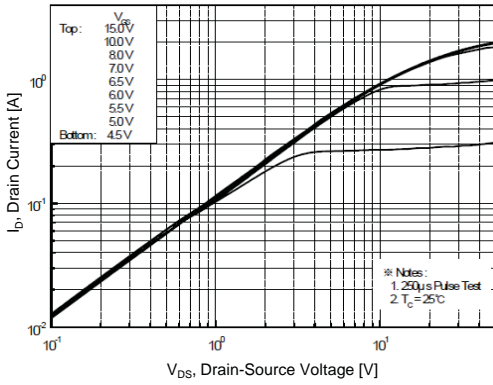

Figure 1. On Region Characteristics

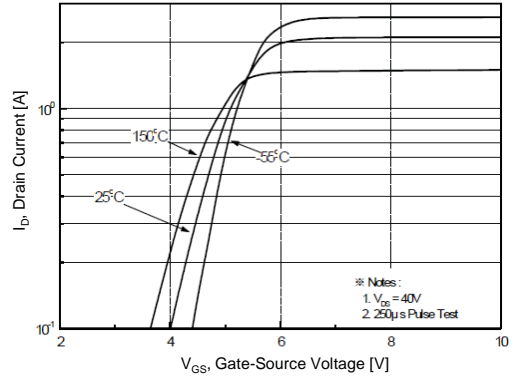

Figure 2. Transfer Characteristics

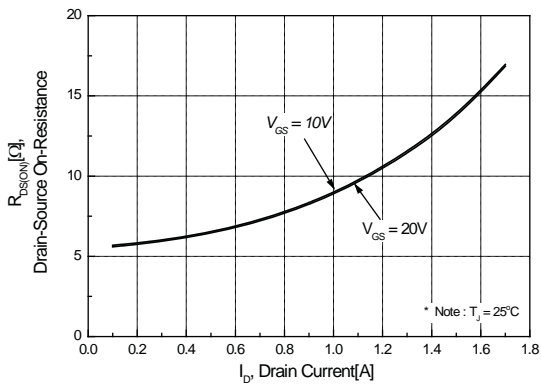

Figure 3. On Resistance Variation vs Drain Current and Gate Voltage

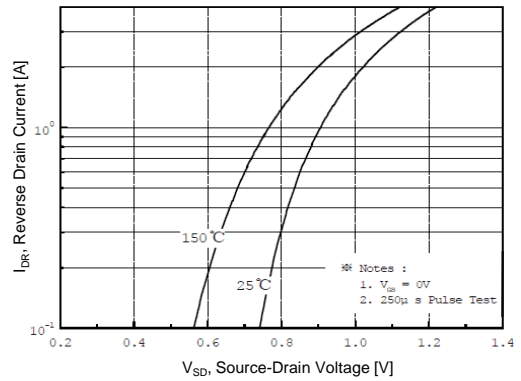

Figure 4. Body Diode Forward Voltage Variation with Source Current and Temperature

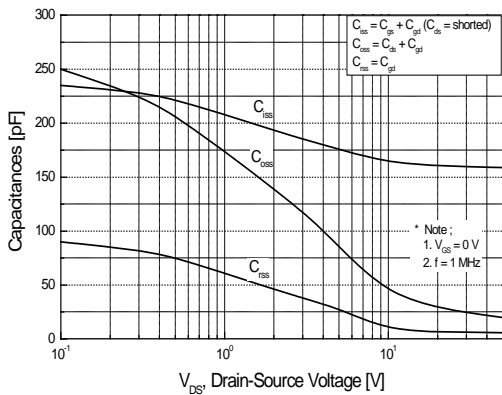

Figure 5. Capacitance Characteristics

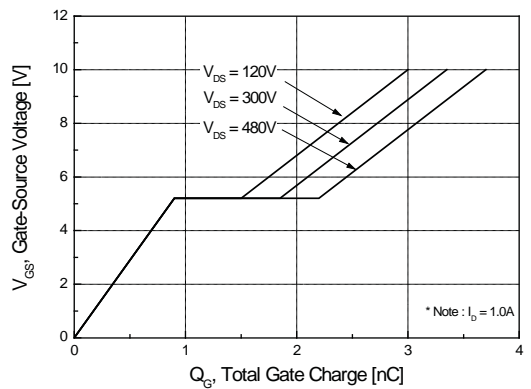

Figure 6. Gate Charge Characteristics

Typical Characteristics (continued)

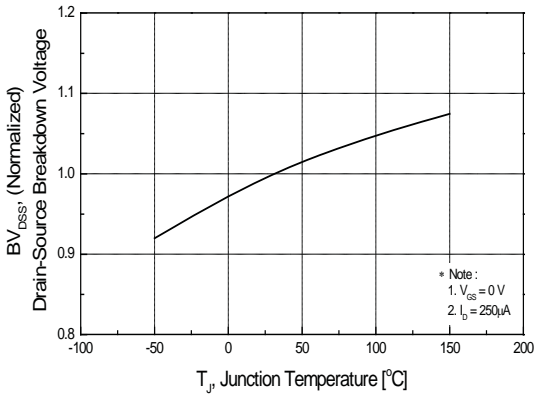

Figure 7. Breakdown Voltage Variation vs Temperature

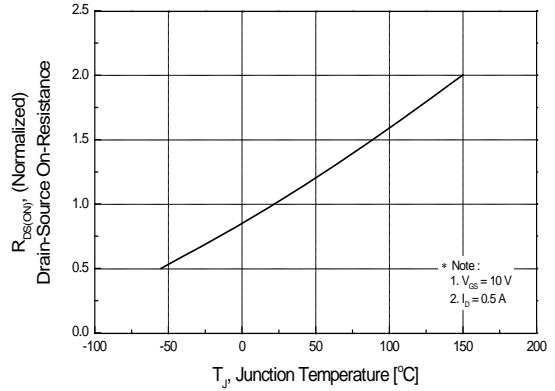

Figure 8. On-Resistance Variation vs Temperature

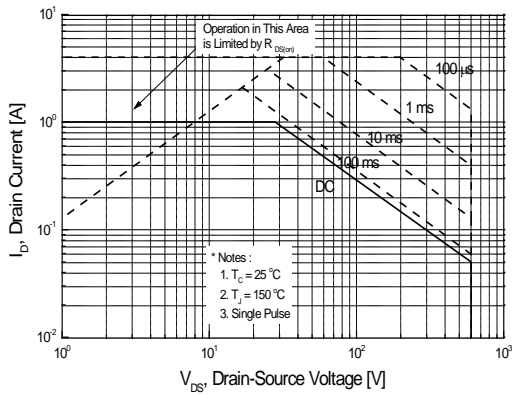

Figure 9. Maximum Safe Operating Area

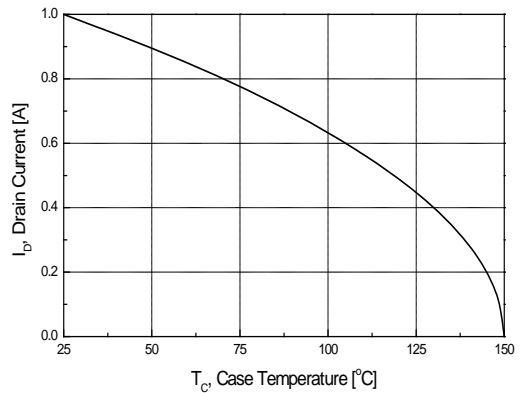

Figure 10. Maximum Drain Current vs Case Temperature

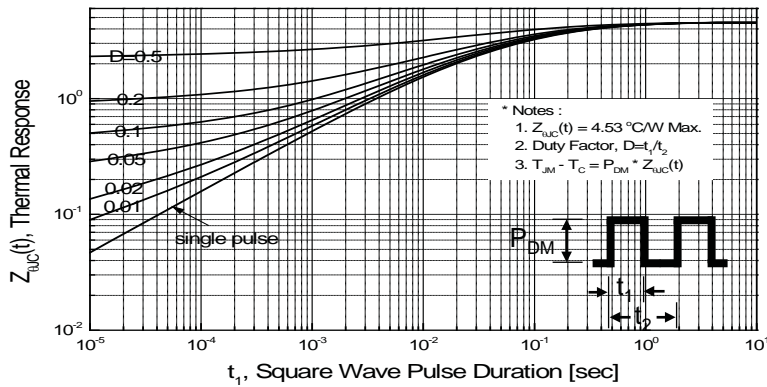
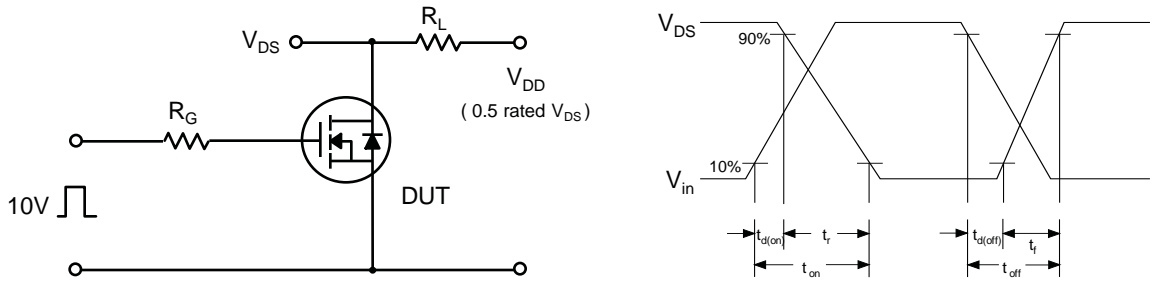

Figure 11. Transient Thermal Response Curve

**Fig 12. Gate Charge Test Circuit & Waveform**



**Fig 13. Resistive Switching Test Circuit & Waveforms**



**Fig 14. Unclamped Inductive Switching Test Circuit & Waveforms**

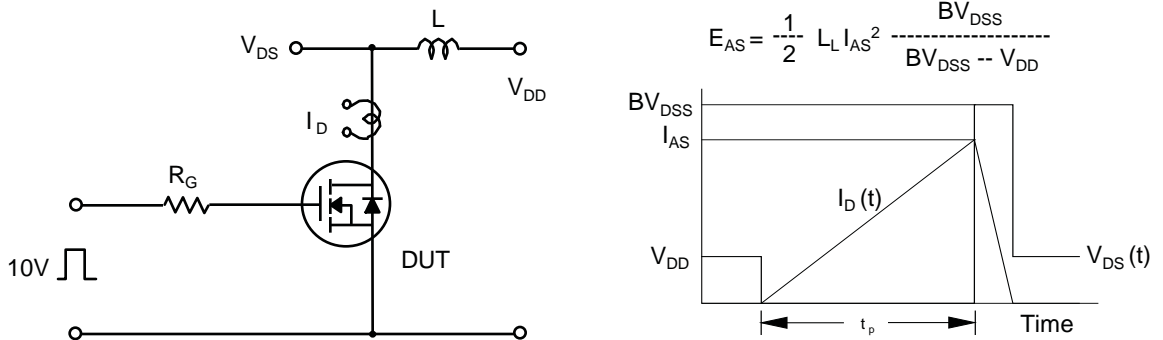
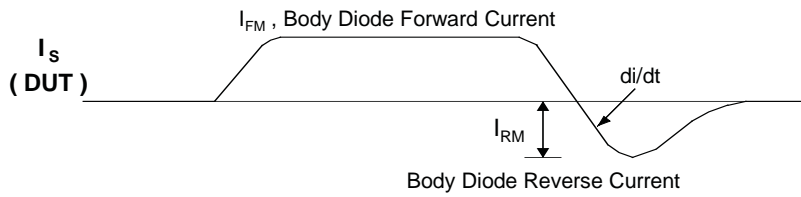
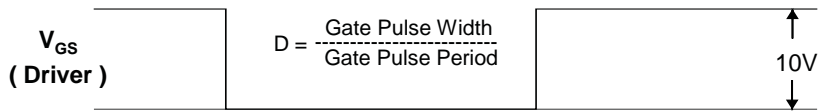
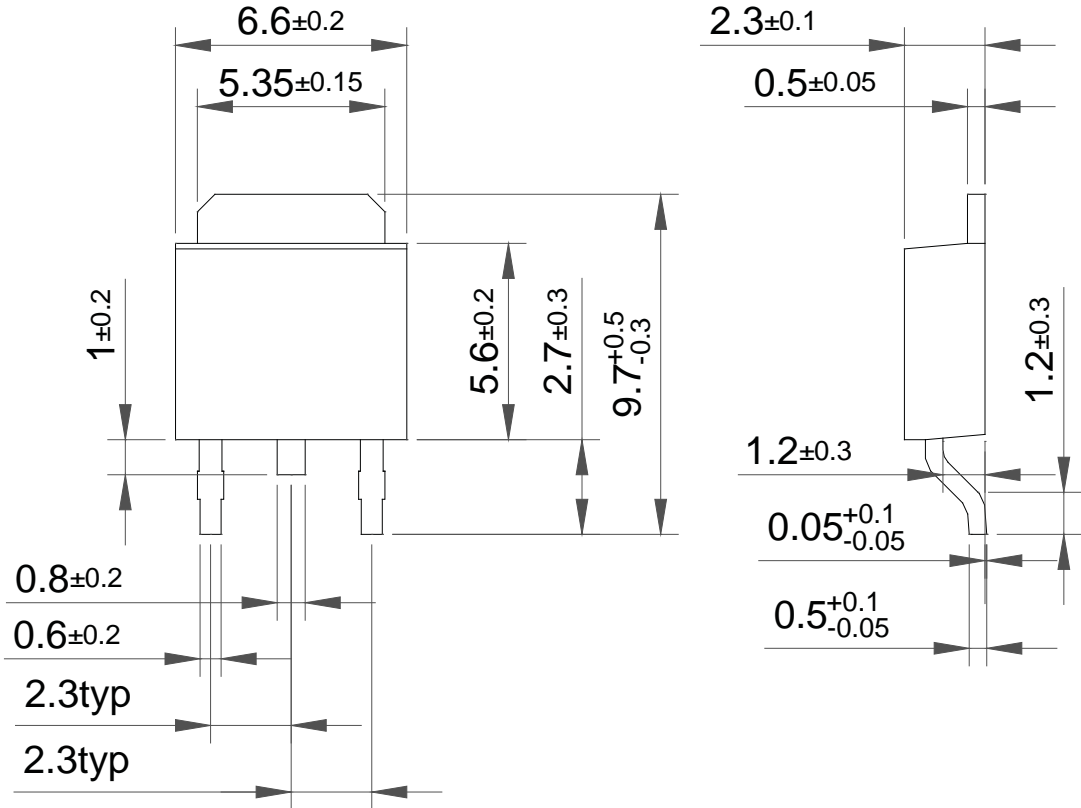

Fig 15. Peak Diode Recovery dv/dt Test Circuit & Waveforms



Package Dimension

D-PAK  
(TO-252)



Package Dimension

I-PAK  
(TO-251)

