

Technical Data Sheet

Power Top View LEDs with Lens

67-31H/B2C-AY1Z0MZ3/CT

Features

- P-LCC-3 package.
- High flux output.
- High current capability.
- Optical indicator.
- Colorless clear window.
- Ideal for backlight and light pipe application.
- Inter reflector.
- Suitable for automatic placement equipment.
- Suitable for reflow and wave solder processes.
- Available on tape and reel (12mm Tape).
- Pb-free.
- The product itself will remain within RoHS compliant version.



Descriptions

- The 67-31H series is available in soft orange, red and yellow. Due to the package design, the LED has wide viewing angle and optimized light coupling by inter reflector. This feature makes the ideal for light pipe application. The low current requirement makes this device ideal for portable equipment or any other application where power is at a premium.

Applications

- Indicator and backlight for audio and video equipment.
- Indicator and backlight in office and family equipment.
- Flat backlight for LCD's, switches and symbols.
- Light pipe application.
- General use.

Device Selection Guide

Chip	Emitted Color	Resin Color
Material		
InGaN	Blue	Water Clear

Technical Data Sheet
Power Top View LEDs with Lens

67-31H/B2C-AY1Z0MZ3/CT

Package Dimensions

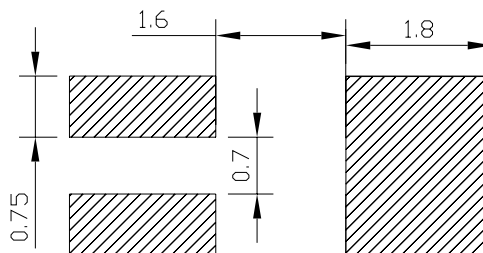
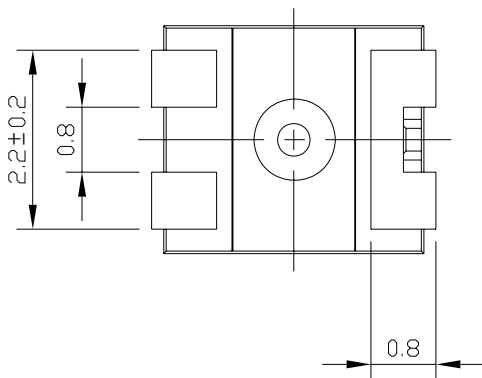
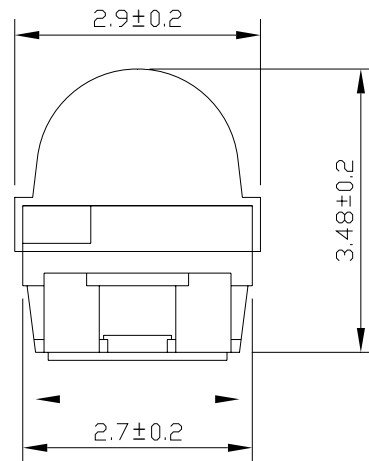
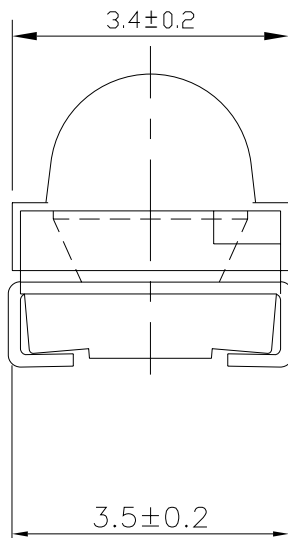
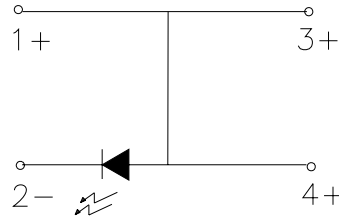
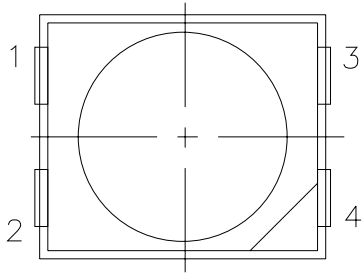

Note: Tolerance unless mentioned is ± 0.1 mm; Unit = mm

Technical Data Sheet
Power Top View LEDs with Lens

67-31H/B2C-AY1Z0MZ3/CT

Absolute Maximum Ratings (T_a=25°C)

Parameter	Symbol	Rating	Unit
Reverse Voltage	V _R	5	V
Forward Current	I _F	50	mA
Peak Forward Current (Duty 1/10 @1KHz)	I _{FP}	100	mA
Power Dissipation	P _d	120	mW
Electrostatic Discharge(HBM)	ESD	2000	V
Operating Temperature	T _{opr}	-40 ~ +85	°C
Storage Temperature	T _{stg}	-40 ~ +90	°C
Soldering Temperature	T _{sol}	Reflow Soldering : 260 °C for 10 sec. Hand Soldering : 350 °C for 3 sec.	

Technical Data Sheet
Power Top View LEDs with Lens

67-31H/B2C-AY1Z0MZ3/CT

Electronic Optical Characteristics

Parameter	Symbol	Min.	Typ.	Max.	Unit	Condition
Luminous Intensity	I _v	2850	-----	7200	mcd	I _F =30mA
Viewing Angle	2θ _{1/2}	-----	30	-----	deg	I _F =30mA
Peak Wavelength	λ _p	-----	468	-----	nm	I _F =30mA
Dominant Wavelength	λ _d	-----	470	-----	nm	I _F =30mA
Spectrum Radiation Bandwidth	Δλ	-----	25	-----	nm	I _F =30mA
Forward Voltage	V _F	2.7	-----	3.7	V	I _F =30mA
Reverse Current	I _R	-----	-----	10	μA	V _R =3V

Notes:

1. Tolerance of Luminous Intensity: ±11%
2. Tolerance of Dominant Wavelength: ±1nm
3. Tolerance of Forward Voltage: ±0.1V

Technical Data Sheet
Power Top View LEDs with Lens

67-31H/B2C-AY1Z0MZ3/CT

Bin Range of Luminous Intensity

Bin Code	Min.	Max.	Unit	Condition
Y1	2850	3600	mcd	I _F =30mA
Y2	3600	4500		
Z01	4500	5700		
Z02	5700	7200		

Bin Range of Dominant Wavelengths

Bin Code	Min.	Max.	Unit	Condition
A8	460.5	465.5	nm	I _F =30mA
A9	463.5	468.5		

Bin Range of Forward Voltage

Bin Code	Min.	Max.	Unit	Condition
00	1.55	1.75	V	I _F =30mA
0	1.75	1.95		
1	1.95	2.15		

Notes:

1. Tolerance of Luminous Intensity: $\pm 11\%$
2. Tolerance of Dominant Wavelength: $\pm 1\text{nm}$
3. Tolerance of Forward Voltage: $\pm 0.1\text{V}$

Technical Data Sheet
Power Top View LEDs with Lens

67-31H/B2C-AY1Z0MZ3/CT

Typical Electro-Optical Characteristic Curves

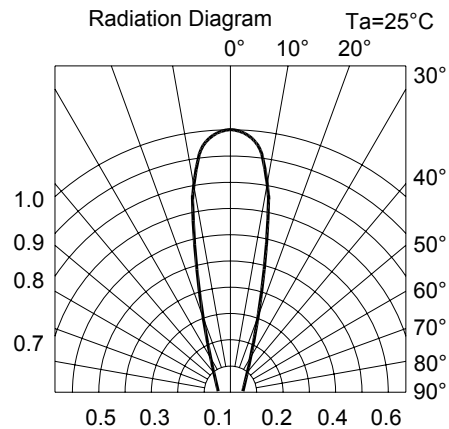
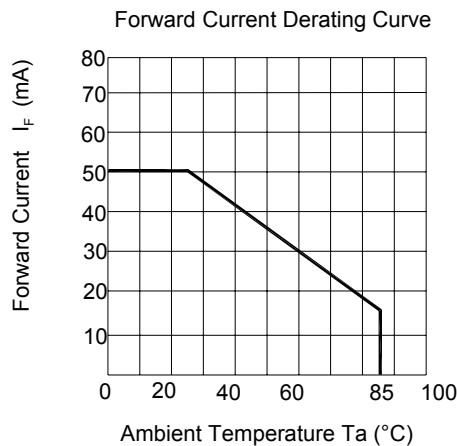
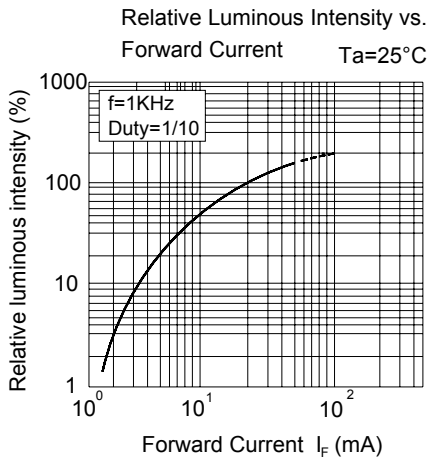
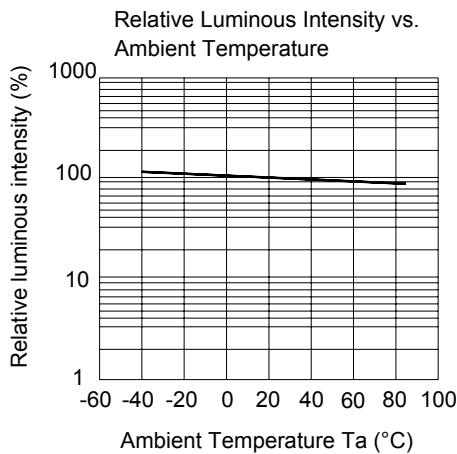
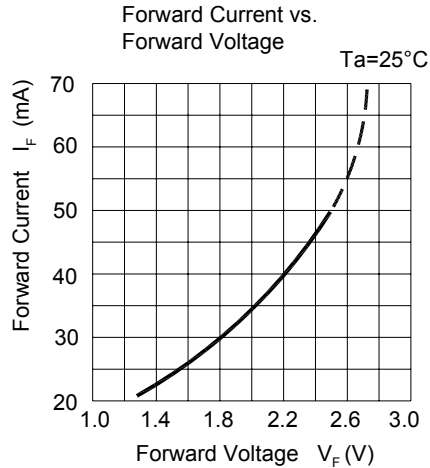
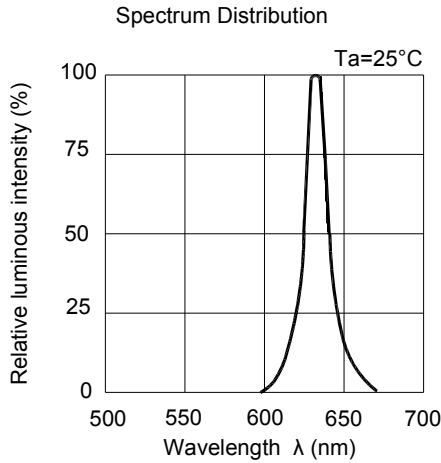

Technical Data Sheet
Power Top View LEDs with Lens

67-31H/B2C-AY1Z0MZ3/CT

Label Explanation

- (1) CPN : Customer's Product Number
- (2) P/N : Product Number
- (3) QTY : Packing Quantity
- (4) CAT : Luminous Intensity Rank
- (5) HUE : Dom. Wavelength Rank
- (6) REF : Forward Voltage Rank
- (7) LOT No : Lot Number

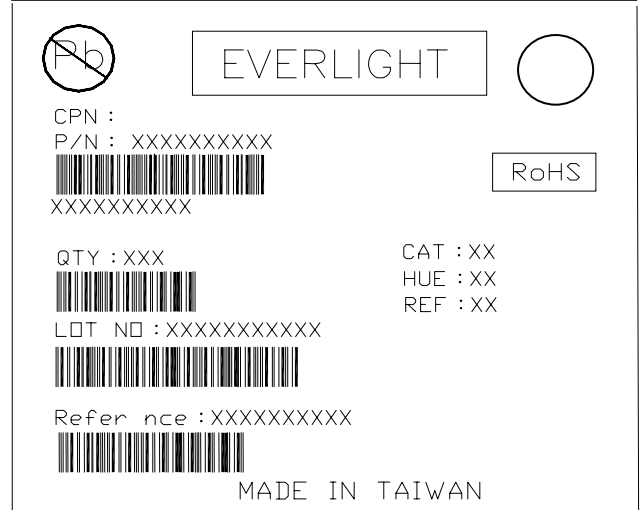

Reel Dimensions

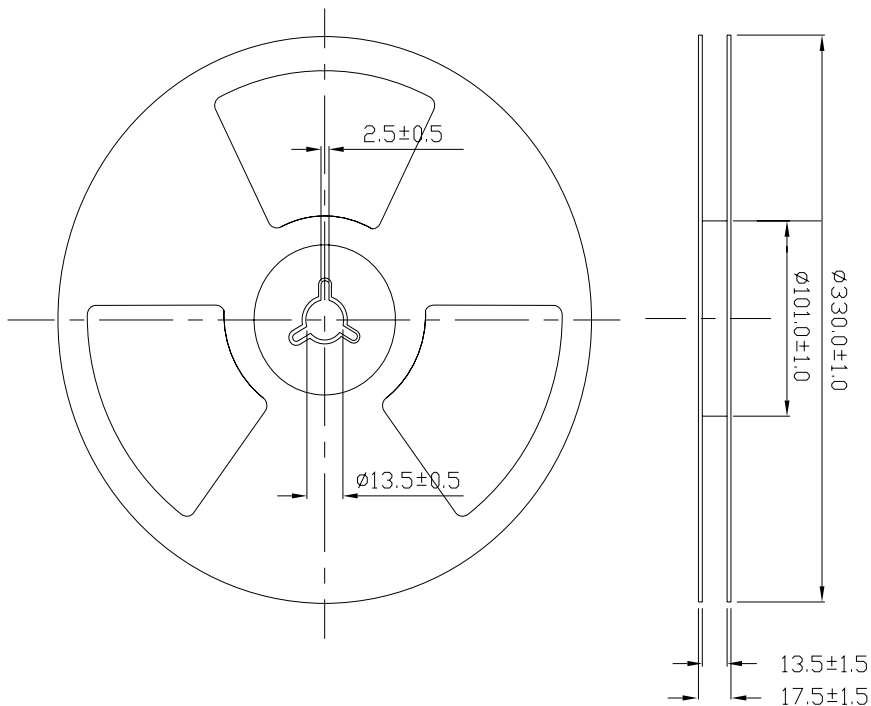

Note : Tolerance unless dimension ± 0.1 mm. Unit = mm

Technical Data Sheet
Power Top View LEDs with Lens

67-31H/B2C-AY1Z0MZ3/CT

Carrier Tape Dimensions: Loaded Quantity 2000 pcs Per Reel

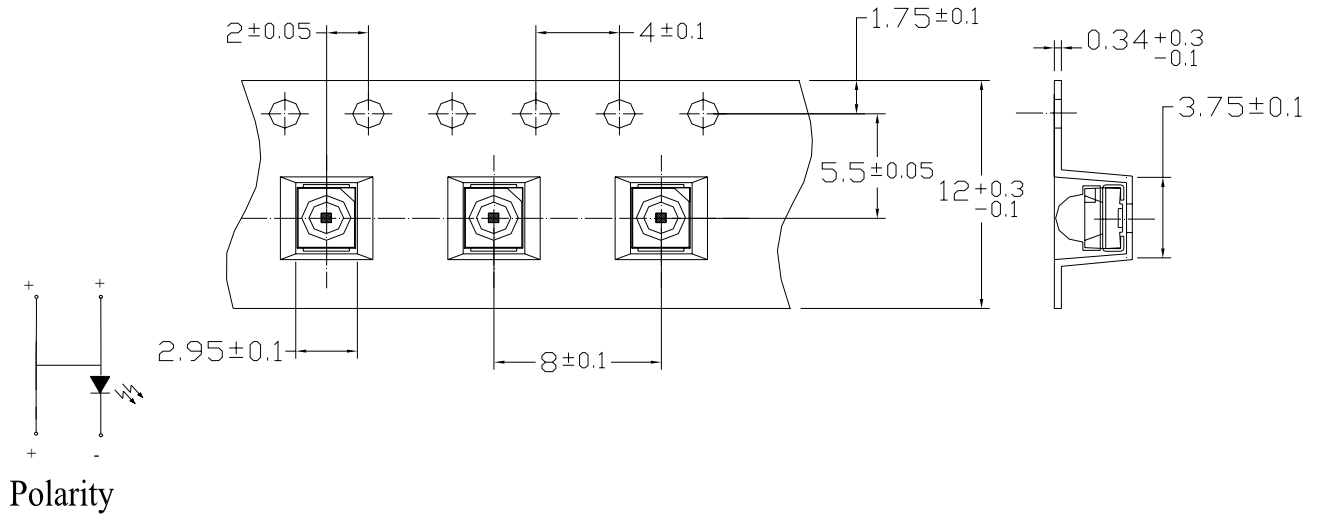

Note : Tolerance unless dimension ± 0.1 mm; Unit = mm

Moisture Resistant Packing

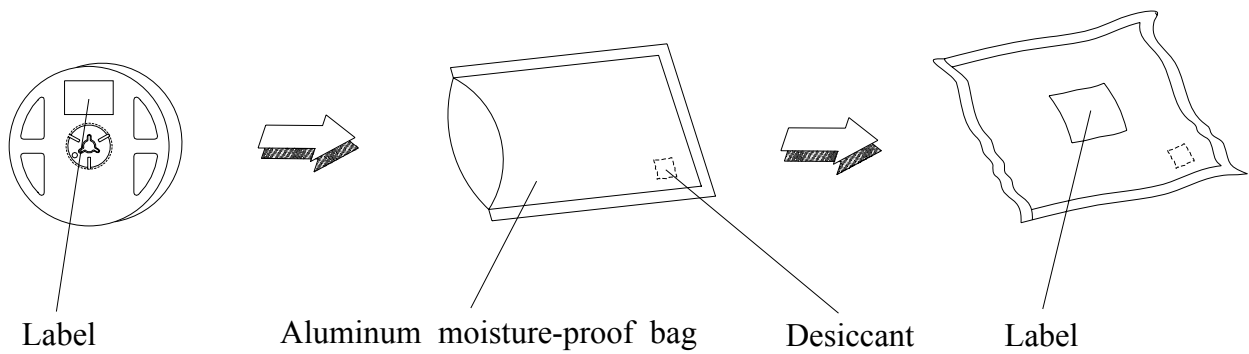

Technical Data Sheet
Power Top View LEDs with Lens

67-31H/B2C-AY1Z0MZ3/CT

Reliability Test Items and Conditions

The reliability of products shall be satisfied with items listed below.

Confidence level : 90%

LTPD : 10%

No.	Items	Test Condition	Test Hours/Cycles	Sample Size	Ac/Re
1	Reflow Soldering	Temp. : 260°C±5°C Min. 5 sec.	6 Min.	22 PCS	0/1
2	Temperature Cycle	H : +100°C 15min ∫ 5 min L : -40°C 15min	300 Cycles	22 PCS.	0/1
3	Thermal Shock	H : +100°C 5min ∫ 10 sec L : -10°C 5min	300 Cycles	22 PCS.	0/1
4	High Temperature Storage	Temp. : 100°C	1000 Hrs.	22 PCS.	0/1
5	Low Temperature Storage	Temp. : -40°C	1000 Hrs.	22 PCS.	0/1
6	DC Operating Life	I _F = 50 mA / 25°C	1000 Hrs.	22 PCS.	0/1
7	High Temperature / High Humidity	85°C/85%RH	1000 Hrs.	22 PCS.	0/1

Technical Data Sheet
Power Top View LEDs with Lens

67-31H/B2C-AY1Z0MZ3/CT

Precautions for Use

1. Over-current-proof

Customer must apply resistors for protection, otherwise slight voltage shift will cause big current change (Burn out will happen).

2. Storage

2.1 Do not open moisture proof bag before the products are ready to use.

2.2 Before opening the package: The LED should be kept at 30°C or less and 90%RH or less.

2.3 After opening the package: The LED floor life is 1 year under 30°C or less and 60% RH or less. If unused LED remain, it should be stored in moisture proof packages.

2.4 If the moisture absorbent material (silica gel) has faded away or the LED have exceeded the storage time, baking treatment should be performed using the following conditions.

Baking treatment : 60±5°C for 24 hours.

3. Soldering Condition

3.1 Pb-free solder temperature profile

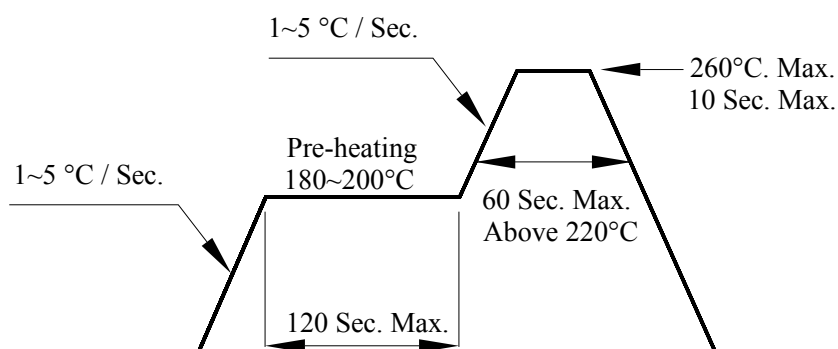

3.2 Reflow soldering should not be done more than two times.

3.3 When soldering, do not put stress on the LEDs during heating.

3.4 After soldering, do not warp the circuit board.

Technical Data Sheet

Power Top View LEDs with Lens

67-31H/B2C-AY1Z0MZ3/CT

4. Soldering Iron

Each terminal is to go to the tip of soldering iron temperature less than 350°C for 3 seconds within once in less than the soldering iron capacity 25W. Leave two seconds and more intervals, and do soldering of each terminal. Be careful because the damage of the product is often started at the time of the hand solder.

5. Repairing

Repair should not be done after the LEDs have been soldered. When repairing is unavoidable, a double-head soldering iron should be used. It should be confirmed beforehand whether the characteristics of the LEDs will or will not be damaged by repairing.

EVERLIGHT ELECTRONICS CO., LTD.
*Office: No 25, Lane 76, Sec 3, Chung Yang Rd,
Tucheng, Taipei 236, Taiwan, R.O.C*

*Tel: 886-2-2267-2000, 2267-9936
Fax: 886-2267-6244, 2267-6189, 2267-6306
<http://www.everlight.com>*