

# SPECIFICATION

## Patent Pending

- Part Number : **FXP611.07.0092C**
- Product Name : **“The Cloud”** Flexible Polymer GPS/GLONASS/COMPASS Cloud Shape Antenna
- Features : 1559-1610 MHz  
38mm\*37mm\*0.15mm size  
92mm Cable  
IPEX MHFI Connector (U.FL compatible)
- RoHS Compliant**



# 1. INTRODUCTION

This convenient “peel and stick” flexible polymer antenna is designed for applications which require high positioning accuracy using GPS, Glonass, Gallileo and even Compass functions on modern day GNSS systems. The antenna is designed to be mounted directly to plastic (e.g. ABS enclosure of a wireless device) and has been designed in a way that makes it extremely resistant to detuning affects caused by the device environment.

# 2. SPECIFICATION

ELECTRICAL	
ANTENNA	
STANDARD	GPS-GLONASS-COMPASS
Operation Frequency (MHz)	1559-1610
Polarization	Linear
Impedance (Ohms)	50
Max VSWR	1.2:1
Peak Gain (dBi)	3
Efficiency (%)	80
Average Gain (dB)	-1
Radiation Properties	Omni-directional
Max Input Power (Watts)	5

\* The FXP611 antenna performance was measured with 30X30 cm ABS Plastic.

MECHANICAL	
Antenna	
Standard	GPS-GLONASS-COMPASS
Dimensions (mm)	38x37x0.15
Required Space (mm)	40x40x0.2
Material	Flexible Polymer
Connector	MHFI(U.FL Compatible)

\*\* The FXP611 antenna requires at least 1cm clearance to metal or to the main device ground plane

ENVIRONMENTAL	
Antenna	
Standard	GPS-GLONASS-COMPASS
Operation Temperature	-40°C to 85°C
Storage Temperature	-40°C to 105°C
Relative Humidity	40% to 95%
RoHS Compliant	Yes

### 3. TEST SET UP

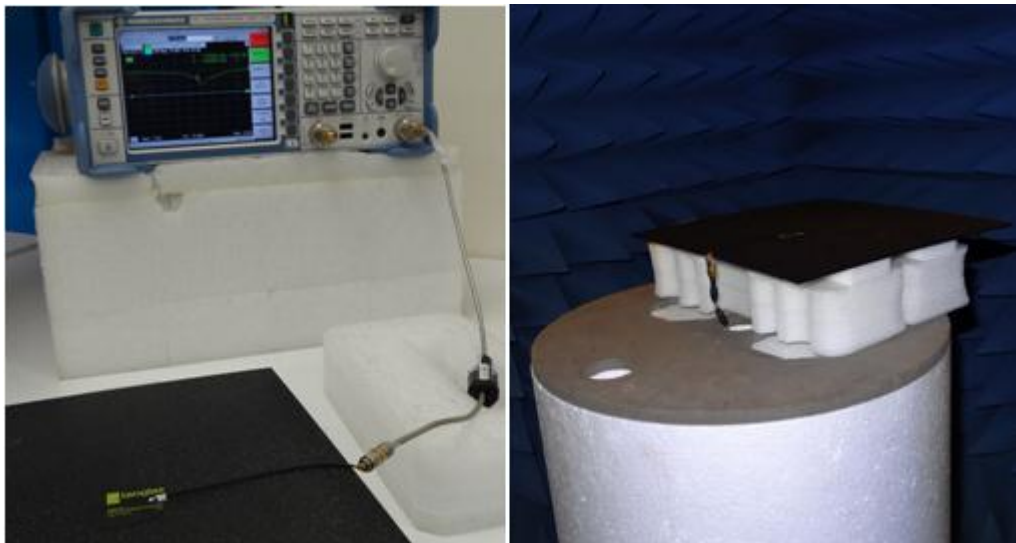

**Figure 1:** Impedance, isolation and correlation coefficient measurements (left hand) and peak gain, average gain, efficiency and radiation pattern measurements (right hand)

## 4. ANTENNA PARAMETERS

### 4.1. Return Loss

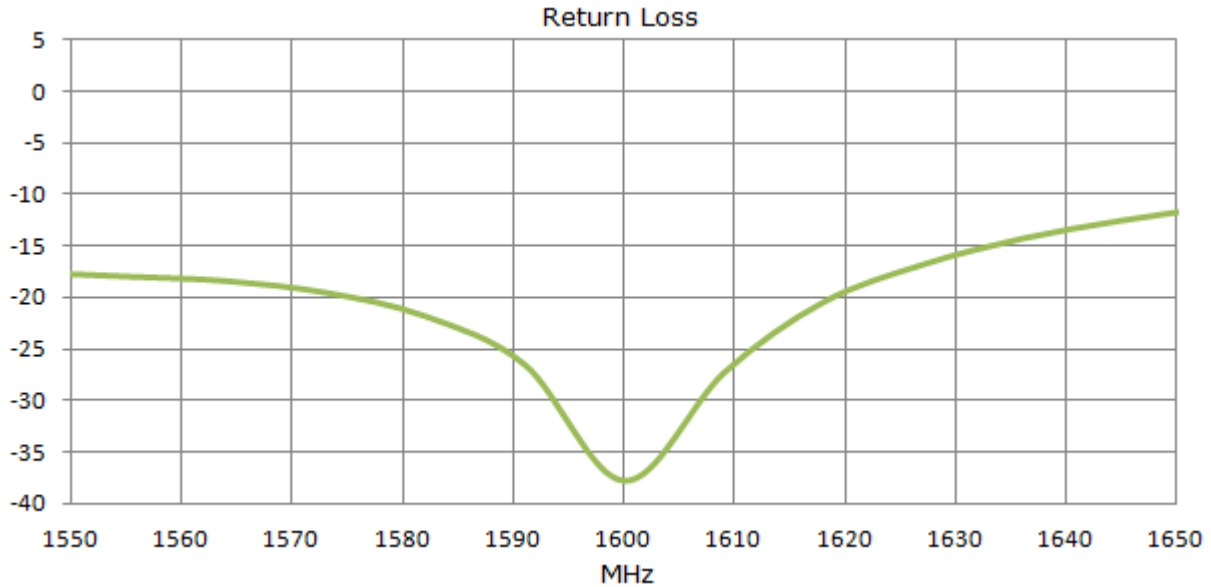

**Figure 2:** Return loss of FXP611 GPS/GLONASS/COMPASS Antenna

### 4.2. VSWR

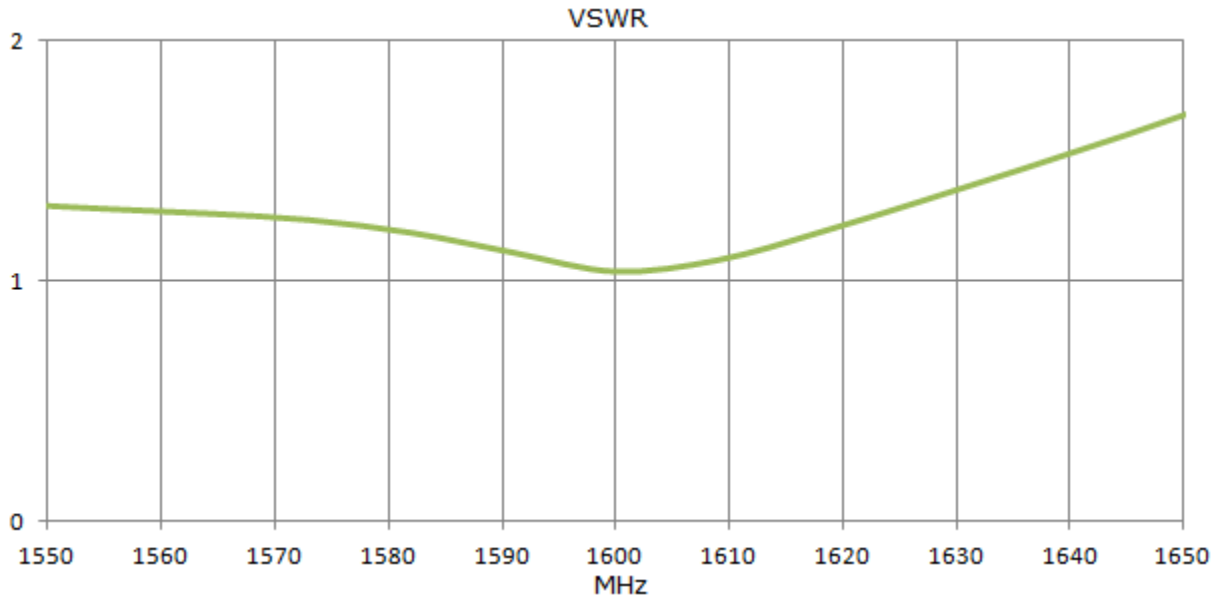

**Figure 3:** VSWR of FXP611 GPS/GLONASS/COMPASS Antenna

### 4.3. Efficiency

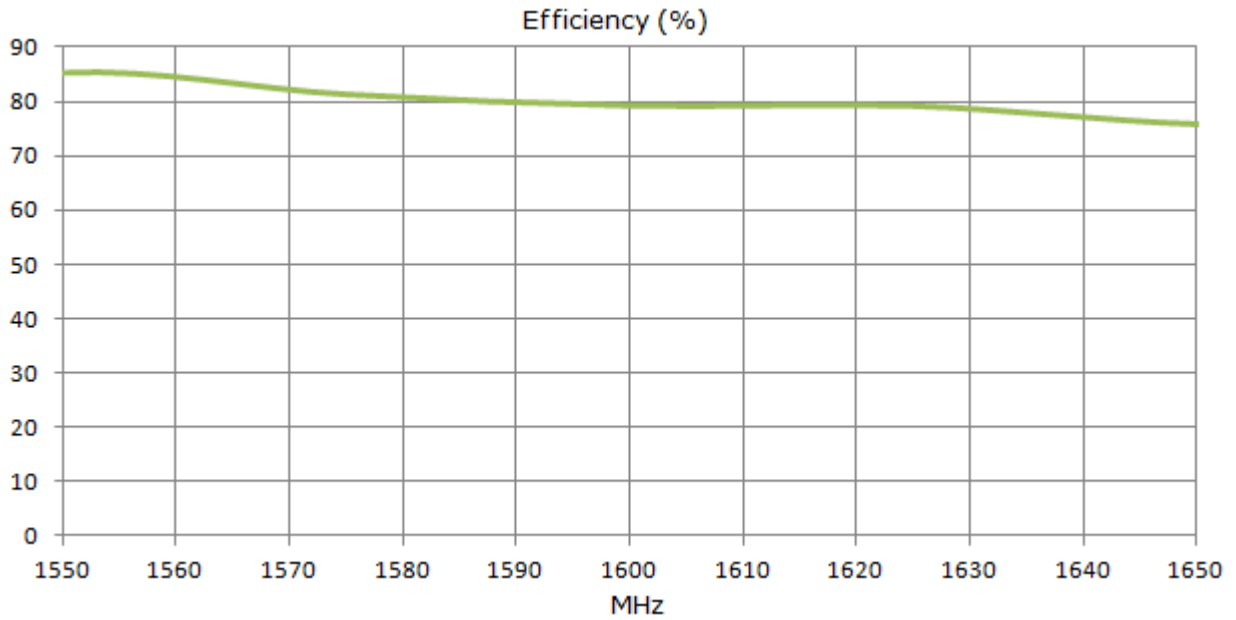

Figure 4: Efficiency of FXP611 GPS/GLONASS/COMPASS Antenna

### 4.4. Peak Gain

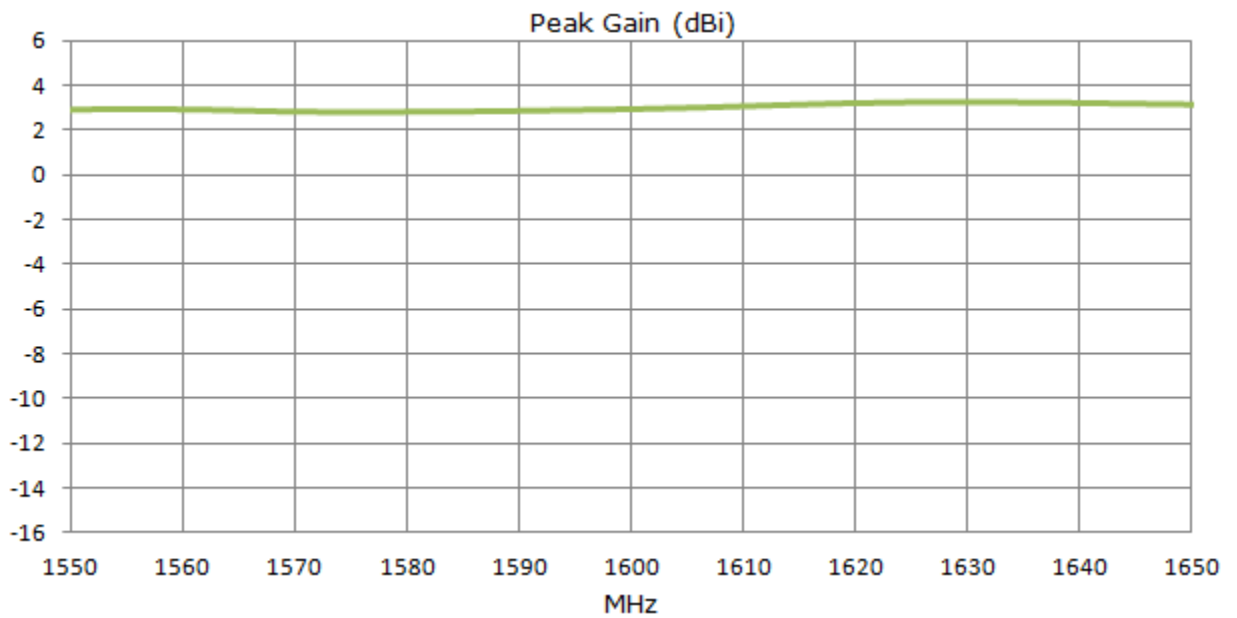

Figure 5: Peak Gain of FXP611 GPS/GLONASS/COMPASS Antenna

## 4.5. Average Gain

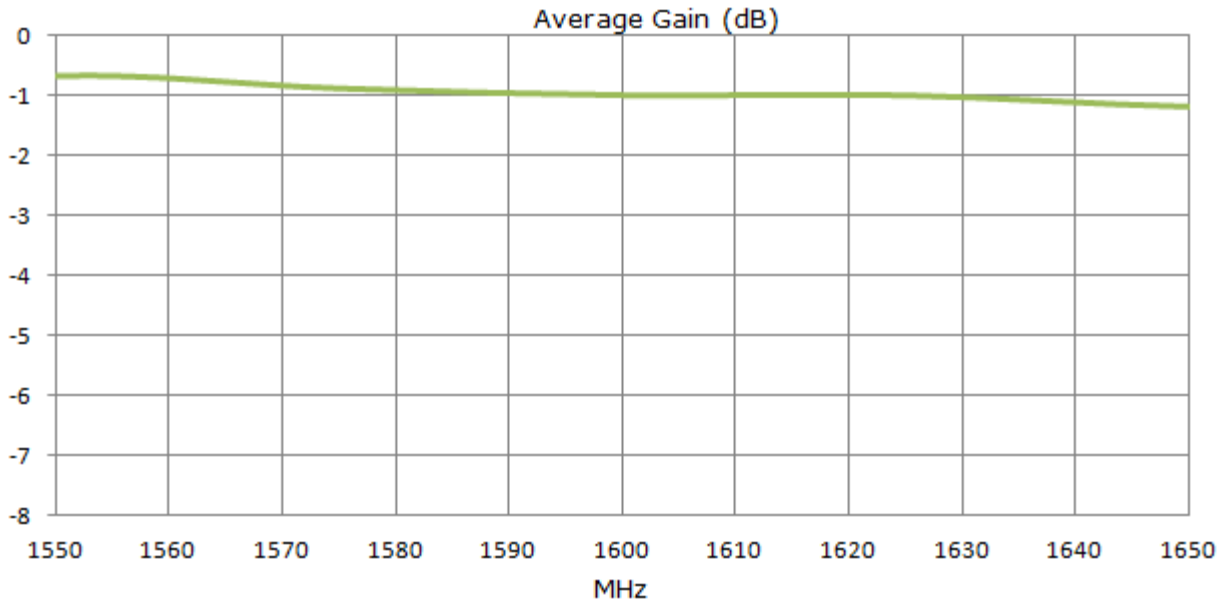

Figure 6: Average Gain of FXP611 GPS/GLONASS/COMPASS Antenna

## 4.6. Radiation Pattern

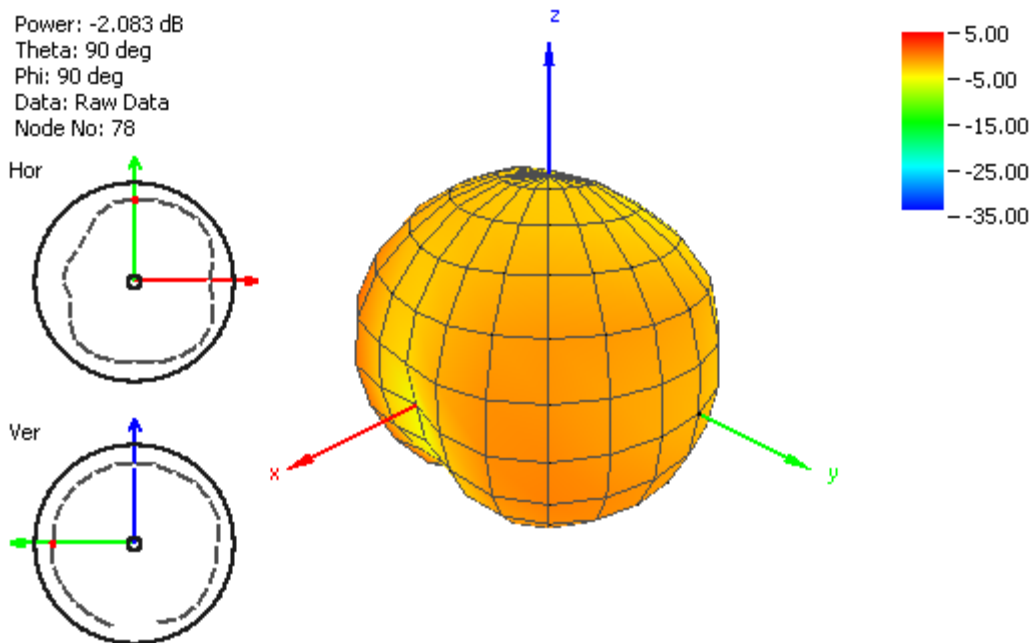
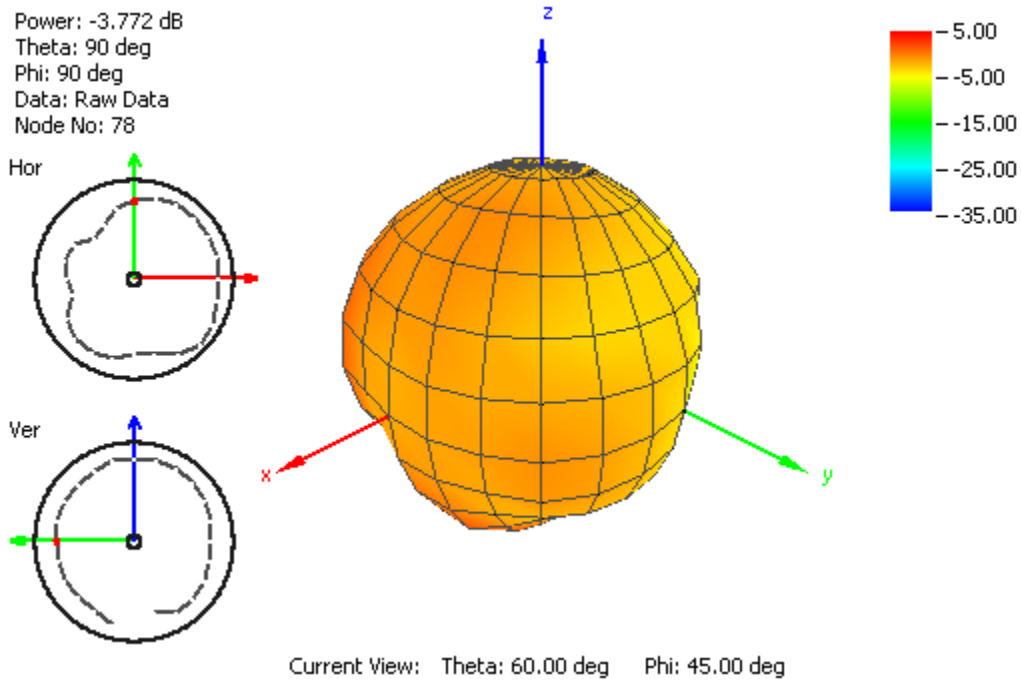
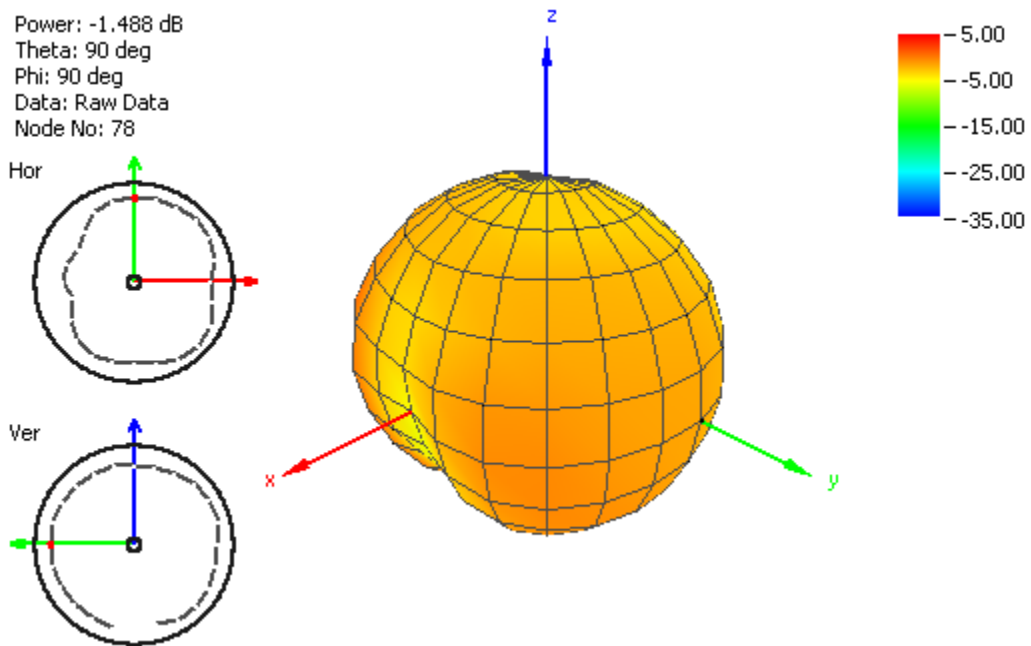

Figure 7: Radiation Pattern of FXP611 GPS/GLONASS/COMPASS Antenna at 1561MHz



**Figure 8:** Radiation Pattern of FXP611 GPS/GLONASS/COMPASS Antenna at 1575MHz



**Figure 9:** Radiation Pattern of FXP611 GPS/GLONASS/COMPASS Antenna at 1589MHz

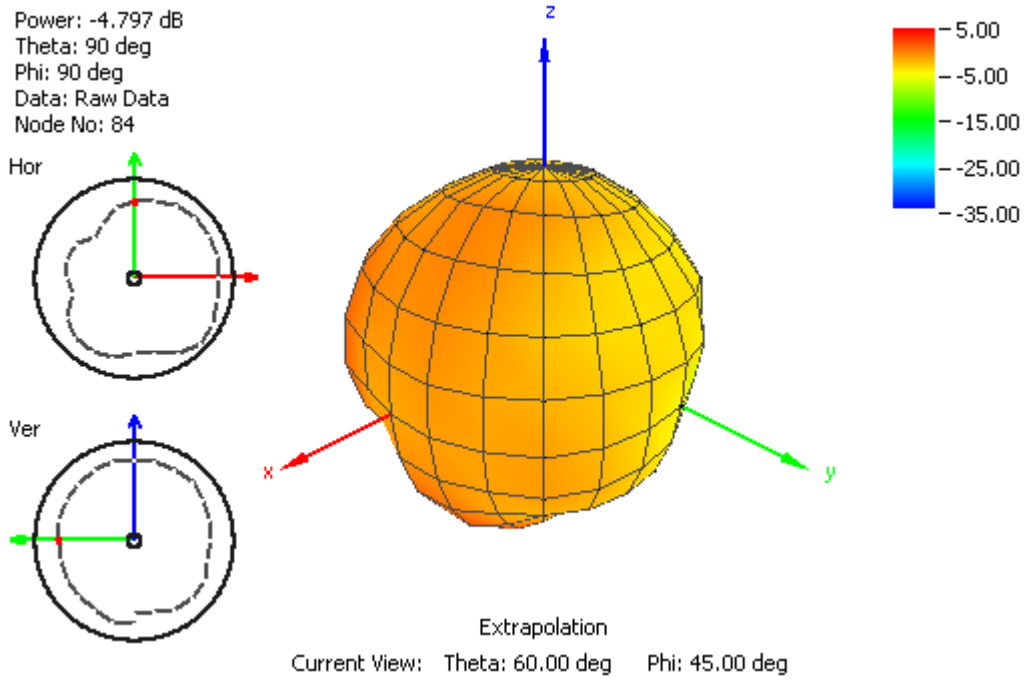
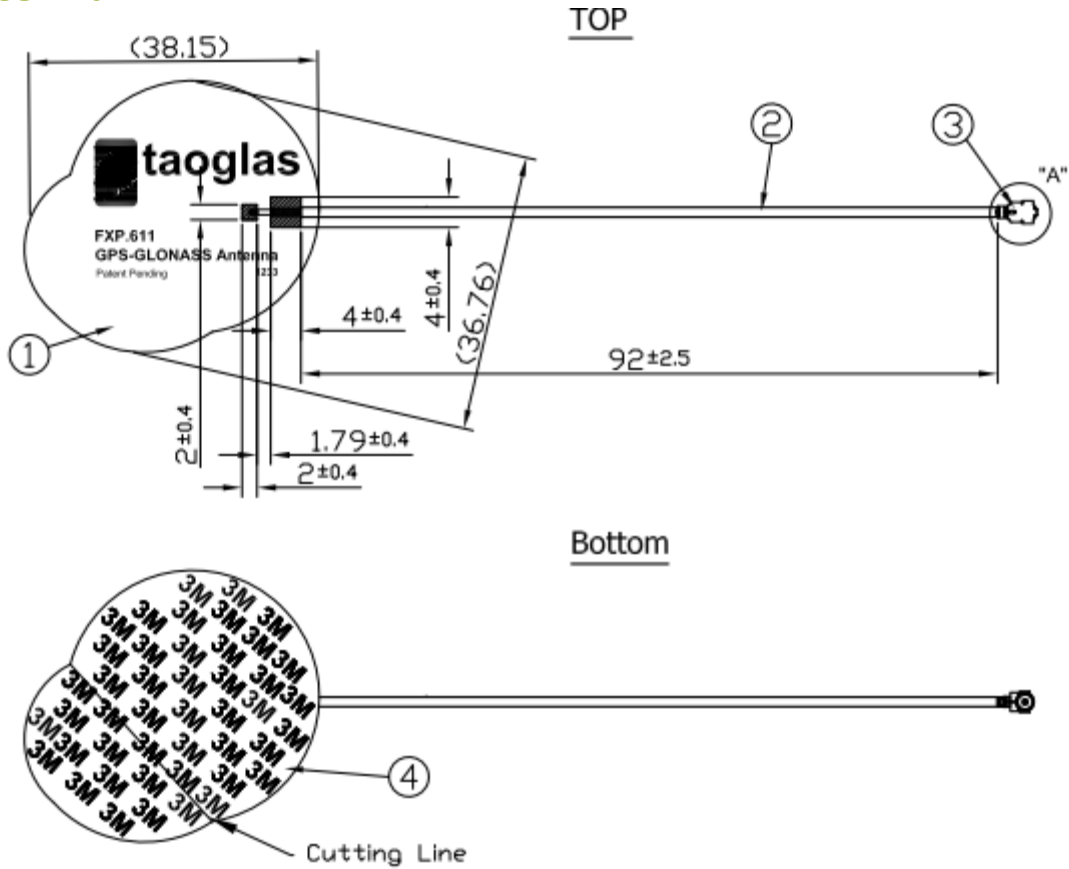

**Figure 10:** Radiation Pattern of FXP611 GPS/GLONASS/COMPASS Antenna at 1610MHz



# 5. MECHANICAL DRAWING

## 5.1 Antenna



1	FXP.611 PCB
2	1.37mm Coaxial Cable
3	IPEX MHFI connector
4	3M Tape

## 5.2 Connector

