

# IRPP3637-12A *POWIR+* Chipset Reference Design



## 12Amp Single Phase Synchronous Buck *POWIR+*™ Chipset Reference Design using IR3637SPBF PWM & Driver IC and IRF7823PBF & IRF7832ZPBF SO-8 MOSFETs

*By Steve Oknaian, Senior Applications Engineer*

### Table of Contents

	<b>Page</b>
Introduction .....	2
Design Details .....	2
Start-Up Procedure .....	3
Layout Considerations .....	4
Circuit Schematic .....	5
Complete Bill of Materials.....	6
PCB layouts .....	7-8
Electrical Efficiency & Power Loss .....	9
Thermal Performance & Bode Plot.....	10
Input & Output Ripple Waveforms.....	11
Load Step Waveforms.....	12
Power Up & Power Down Waveforms.....	13
Short Circuit Waveforms .....	14
IRPP3637-xxA Reference Design Selector Table .....	14

## Introduction

The IRPP3637- 12A is an optimized POWIR+™ Chipset reference design, targeted at low cost, low-to-medium power synchronous buck applications up to 12A output current. The IRPP3637-12A uses International Rectifier's IR3637SPBF single channel PWM controller in an 8-pin SOIC and IRF7823PBF & IRF7832ZPBF SO-8 MOSFETs. The IRF7823PBF is utilized as a high side control FET, and the IRF7832ZPBF is utilized as a low side synchronous FET. There is an option to also populate the MOSFET sockets with small can DirectFET® MOSFETs to meet different design goal objectives. This reference design has built-in power design expertise regarding component selection and PCB layout, and is representative of a realistic final embedded synchronous buck design, intended to simplify the design in effort without unnecessary design iterations. The design is optimized for 12V input and 1.8V output @ 12A and 400kHz switching frequency, including considerations on layout and passive & magnetic component selection. The IRPP3637-12A delivers the complete 12A design in less than 1.5in<sup>2</sup> board area at up to 84.2% full load electrical efficiency and up to 85.1% peak efficiency.

International Rectifier also offers the POWIR+ Chipset on-line design tool (<http://powirplus.irf.com>) allowing the customization of the IRPP3637-12A reference design to meet individual requirements. Based on specific inputs, the POWIR+ Chipset on-line design tool will provide a tailored schematic and bill of materials, from which the engineer can run a full suite of on-line design simulations, and then order the fully

assembled and tested customized reference design (see details on page 14).

## Design Details

The IRPP3637-12A reference design is optimized for an input voltage range of 12V+/-10% and an output voltage of 1.8V at a maximum of 12A load current, using the IRF7823PBF and IRF7832ZPBF SO-8 MOSFETs.

This chipset is operated at 400kHz switching frequency to allow a good trade off with size and performance at the specified operating conditions. All the essential components that contribute to a low cost compact solution are enclosed by the rectangular box shown on the PCB, showing a total solution size of 1.3" x 1.2" (1.5" sq). The electrical connection diagram is shown in figure 1 and the corresponding circuit schematic is shown in figure 2.

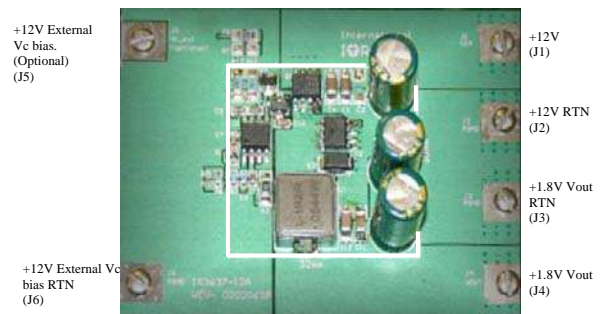

Figure 1: IRPP3637-12A Electrical Connection Diagram

### Input/Output Connections

- J1: Input power connection terminal
- J2: Input power return preferred connection terminal
- J3: Output power return preferred connection terminal
- J4: Output power connection terminal

- J5: External bias power connection terminal. This terminal is unused for standard reference design configuration.
- J6: External bias power return preferred connection terminal. This terminal is unused for standard reference design configuration.

### Start-Up Procedure

The 12V input power is connected between terminals J1 and J2 and the 1.8V, 12A output power is obtained through terminals J3 and J4.

The  $V_{CC}$  and  $V_C$  pins are the low side driver and high side driver power input pins respectively. The  $V_{CC}$  pin also includes the housekeeping power of the PWM controller. An under-voltage lockout (UVLO) feature is associated with each of these pins, which is set to 4.2V for  $V_{CC}$  and 3.3V for  $V_C$ . A charge pump circuit comprised of C14, D1, and C16 applies adequate voltage to the  $V_C$  pin to allow fast driving capability, hence reducing the switching losses of the control FET (Q1). A 25Ω resistor (R11 in parallel with R12) is added in series with the charge pump circuit to maintain the  $V_C$  voltage below 20V to reduce the temperature of the PWM controller IC.

Upon application of the input power, the output starts ramping up to regulation within 4ms. The ramping time can be adjusted through the soft start capacitor C5. The output voltage of the synchronous buck regulator is set to 1.8V using the internal 0.8V reference voltage.

The following equations are used to calculate the MOSFET power loss. Refer to the IRF7823PBF and IRF7832ZPBF datasheets to select the parametric values of the power loss equations terms.

### Control FET Losses:

Eq (1):

$$P_{Q1} = I_{Q1}^{rms2} \cdot R_{DQ1} \cdot R_{Dn} + (I_o \cdot \frac{Q_{sw1}}{I_{g1}} \cdot V_{in} + Q_{gQ1} \cdot V_{dd} + Q_{ossQ1} \cdot V_{in}) \cdot F_{sw}$$

### Synchronous FET Losses:

Eq (2):

$$P_{Q2} = I_{Q2}^{rms2} \cdot R_{DQ2} \cdot R_{Dn} + \left( \frac{Q_{ossQ2}}{2} \cdot V_{in} + Q_{gQ2} \cdot V_{dd} + Q_{rrQ2} \cdot V_{in} \right) \cdot F_{sw}$$

### Deadtime losses:

Eq (3):

$$P_{td} = V_{SD} \cdot I_o \cdot t_d \cdot F_{sw}$$

### Total FET losses:

Eq (4):

$$P_{FET\_total} = P_{Q1} + P_{Q2} + P_{td}$$

Where,

$I_{Q1rms}$  and  $I_{Q2rms}$  are the rms currents for control and sync FETs respectively, in Amps

$I_o$  is the output load current in Amps  
 $R_D$  is the  $R_{DSON}$  in ohms of the FETs and  
 $R_{Dn}$  is the normalized  $R_{DSON}$  factor vs. temperature extracted from the MOSFET datasheets.

$Q_{sw}$  is the FET switch charge in nC

$V_{IN}$  is the input voltage of the sync buck converter

$Q_g$  is the total gate charge in nC.

$V_{dd}$  is the FET drive voltage, which is 8V.

$I_g$  is the drive current which is 0.25A.

$Q_{OSS}$  is the FET output charge in nC.

$Q_{rr}$  is the sync FET internal body diode reverse recovery charge in nC

$V_{SD}$  is the sync FET internal body diode forward voltage drop in volts. If an external Schottky diode is used, then  $V_{SD}$  needs to be the forward voltage drop of the Schottky diode.

$F_{sw}$  is the switching frequency of the sync buck converter in hertz.

$t_d$  is the dead time caused by the PWM controller IC in seconds. This parameter is specified in IR3637SPBF datasheet.

For design calculations related to programming the output voltage and the soft start time, selection of input/output capacitors and output inductor and control loop compensation, refer to the guidelines outlined in the IR3637SPBF PWM controller datasheet.

IR's online design tool POWIR+ should be used to customize a design for applications outside the standard 12V $\pm$ 10% input range and 1.8V output, and for varied design goal objectives.

## Layout Considerations

The IRPP3637-12A reference design PCB layout offers compact design with minimum parasitics at 400kHz switching frequency. The board is designed with 4 layers using 1 oz copper weight per layer. Figures 3a through 3d represent the layout of each layer. To minimize the parasitics, the following was observed:

1. The switch node connection path is made as short as possible by placing the output inductor L1 close to the drain of the synchronous FET.
2. The input decoupling 10 $\mu$ F ceramic capacitors C3 & C4, are placed across the drain of the control FET and the ground plane. The 680 $\mu$ F electrolytic capacitor C1 represents the input bulk capacitance of the synchronous buck regulator.
3. A solid ground plane is furnished in mid-layer 2. The connection of the signal ground to power ground is done at a single point in the bottom layer as shown in figure 3d.
4. The feedback track from the output  $V_{OUT}$  to FB pin of the IC is routed as far away from noise generating traces as possible in mid-layer 2 as shown in figure 3c.

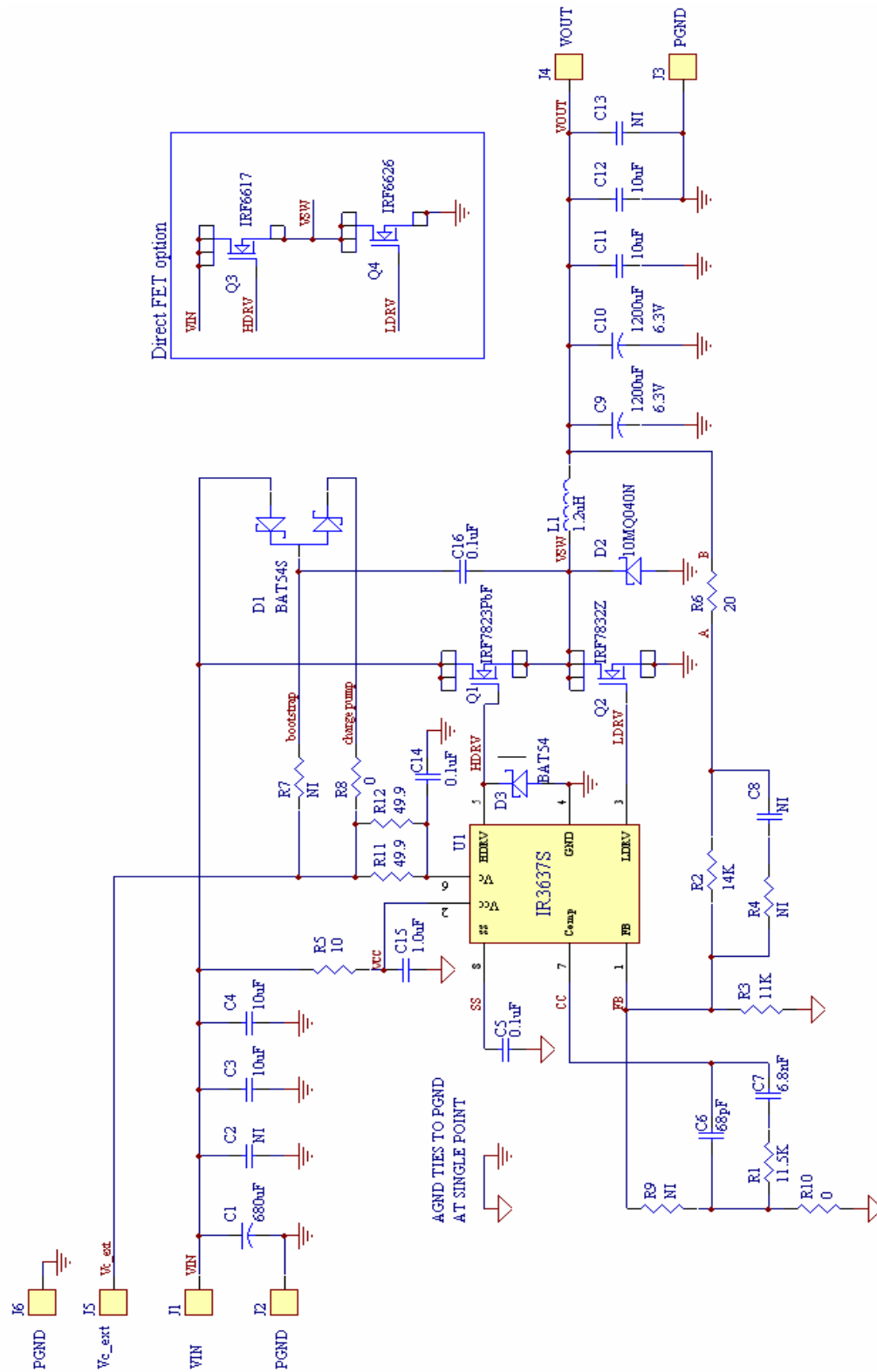

Figure 2: Schematic Diagram for IRPP3637-12A Reference Design

QTY	REF DESIGNATOR	DESCRIPTION	SIZE	MFR	PART NUMBER
1	C6	Capacitor, ceramic, 68pF, 50V,NPO, 5%	0603	KOA	NPO0603HTTD680J
1	C7	Capacitor, ceramic, 6.8nF,50V,X7R	0603	KOA	X7R0603HTTD682K
3	C5, C14, C16	Capacitor, ceramic, 0.1µF, 50V, X7R, 10%	0603	TDK	C1608X7R1H104K
1	C15	Capacitor, ceramic, 1.0µF, 16V, X5R, 10%	0603	TDK	C1608X7R1C105K
2	C3, C4	Capacitor, ceramic, 10uF, 16V, X5R, 20%	1206	TDK	C3216X7R1C106M
2	C11, C12	Capacitor, ceramic, 10uF, 6.3V, X5R, 20%	1206	TDK	C3216X5R0J106M
1	C1	Capacitor, aluminum electrolytic,680uF,16V	8mm X 16mm	Sanyo	16ME680WGL
2	C9,C10	Capacitor, aluminum electrolytic,1200uF,6.3V	8mm X 16mm	Sanyo	6ME1200WG
1	D3	Schottky Diode, 30V,200mA	SOT23	IRF	BAT54
1	D1	Schottky Diode, 30V,200mA	SOT23	IRF	BAT54S
1	D2	Schottky Diode, 40V,1.5A	D64	IRF	10MQ040N
3	J1, J4, J5	Red Banana Jacks-Insulated Solder Terminal	4.44mm	Johnson	108-0902-001
3	J2, J3, J6	Black Banana Jacks-Insulated Solder Terminal	4.44mm	Johnson	108-0903-001
4	J1, J4, J5, J6	Pan Head Slotted,screw 1/2"	-	McMaster-Carr	91792A081
2	J2, J3	Pan Head Slotted,screw 1/4"	-	McMaster-Carr	91792A077
6	J1, J2, J3, J4, J5, J6	Machine Screw Hex Nuts	-	McMaster-Carr	91841A003
1	L1	1.2uH,22A,2.5mΩ	11.5mmX10mmX5.5mm	Delta Electronics	MPL1055-1R2IR
1	R8	Resistor,thick film, 0Ω	0805	ROHM	MCR10EZJH000
1	R10	Resistor,thick film, 0Ω	0603	ROHM	MCR03EZJH000
1	R5	Resistor,thick film,10Ω, 5%	1206	DALE	CRCW1206-100JRT1
1	R6	Resistor,thick film,20Ω, 1%	0603	KOA	RK73H1JLTD20R0F
2	R11,R12	Resistor,thick film,49.9Ω, 1%	1206	KOA	RK73H2B49R9F
1	R1	Resistor,thick film,11.5kΩ, 1%	0603	KOA	RK73H1JLTD1152F
1	R3	Resistor,thick film,11kΩ, 1%	0603	KOA	RK73H1JLTD1102F
1	R2	Resistor,thick film,14kΩ, 1%	0603	KOA	RK73H1JLTD1402F
1	Q1	N-FET,30V,8.7mΩ,9.1nC	SO-8	IR	IRF7823PbF
1	Q2	N-FET,30V,3.8mΩ,30nC	SO-8	IR	IRF7832Z
1	U1	PWM Controller	SO-8	IR	IR3637SPbF
6	C2, C8, C13, R4, R7,	Not installed			

Table 1 – Complete Bill of Materials for IRPP3637-12A Reference Design

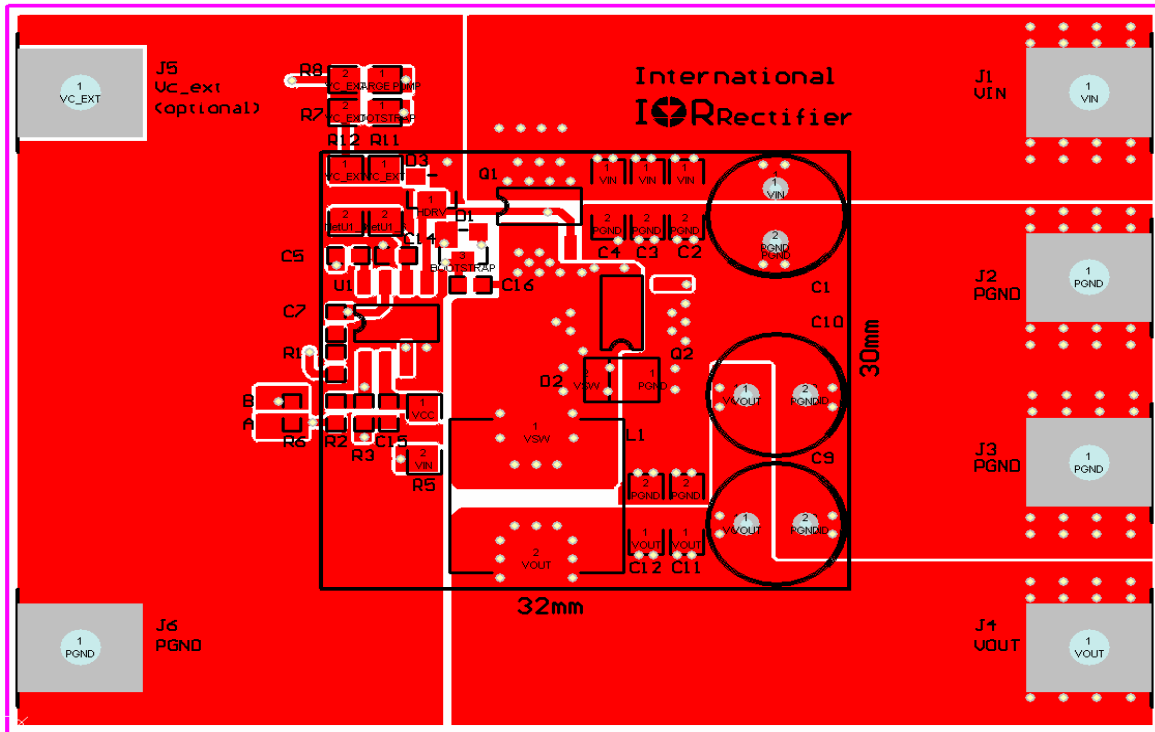

Figure 3a: IRPP3637-12A Reference Design top layer placement and layout.

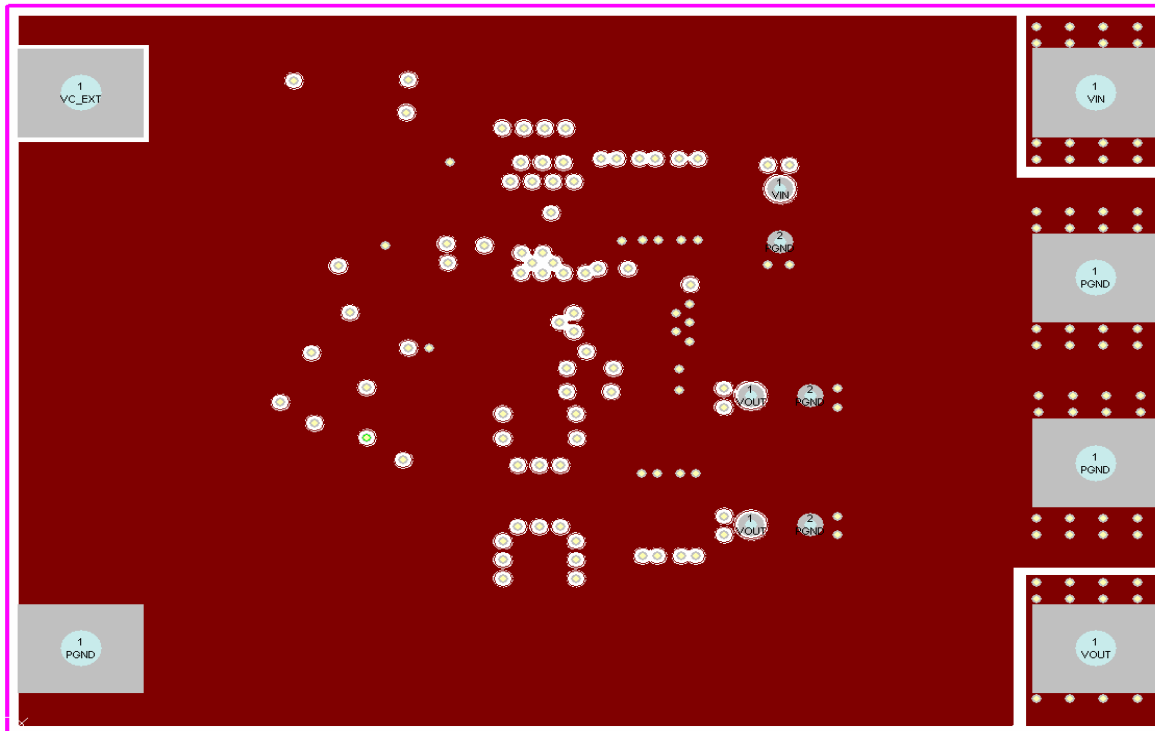

Figure 3b: IRPP3637-12A Reference Design mid-layer1 ground plane

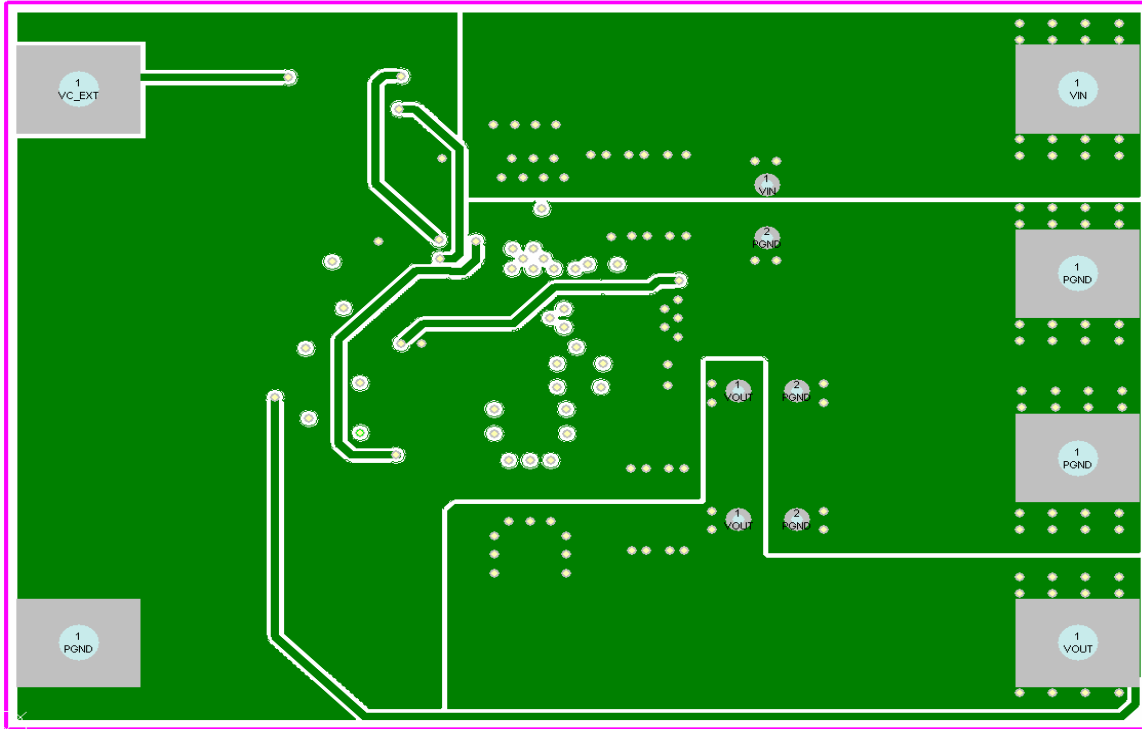

Figure 3c: IRPP3637-12A Reference Design mid-layer2 layout.

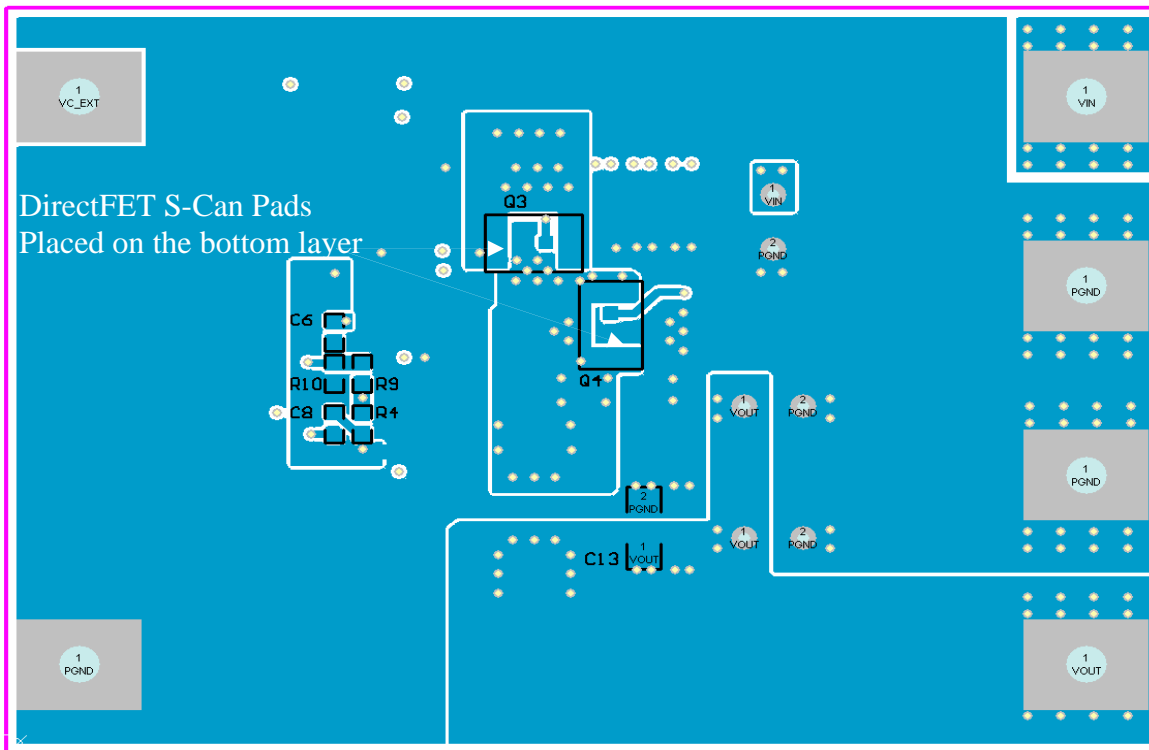

Figure 3d: IRPP3637-12A Reference Design bottom layer layout.



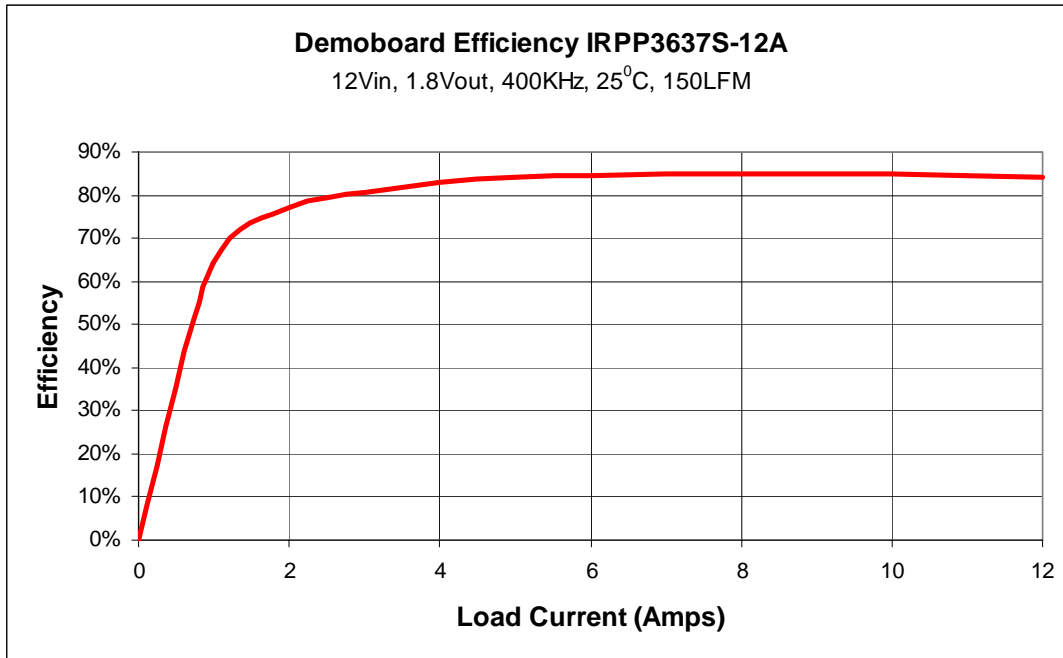

Figure 4a: IRPP3637-12A Reference Design Electrical Efficiency

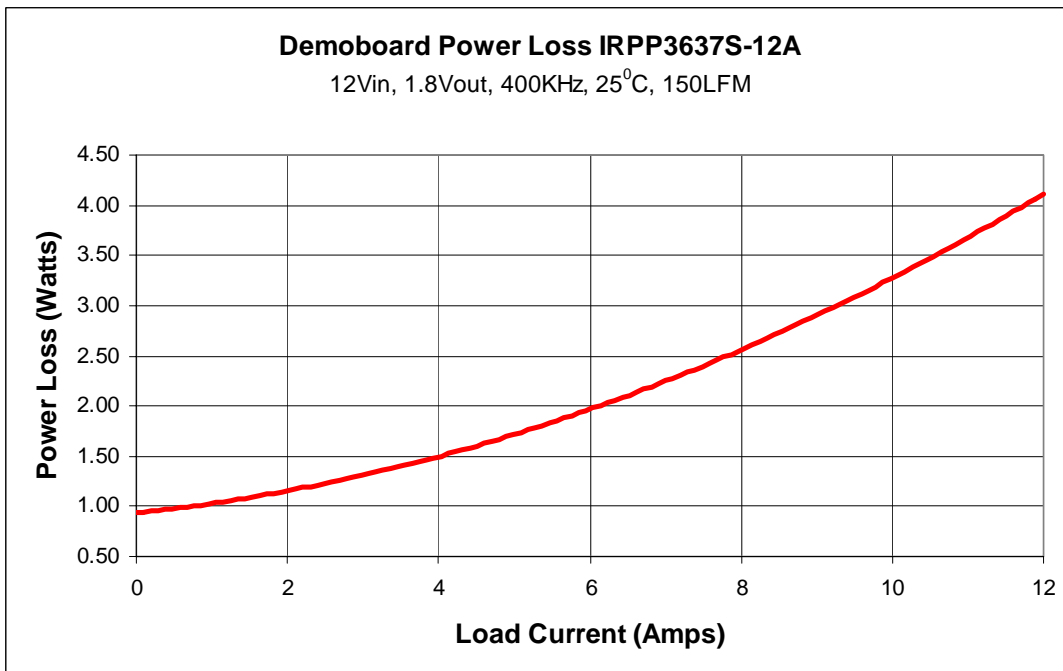

Figure 4b: IRPP3637-12A Reference Design Power Loss Curve

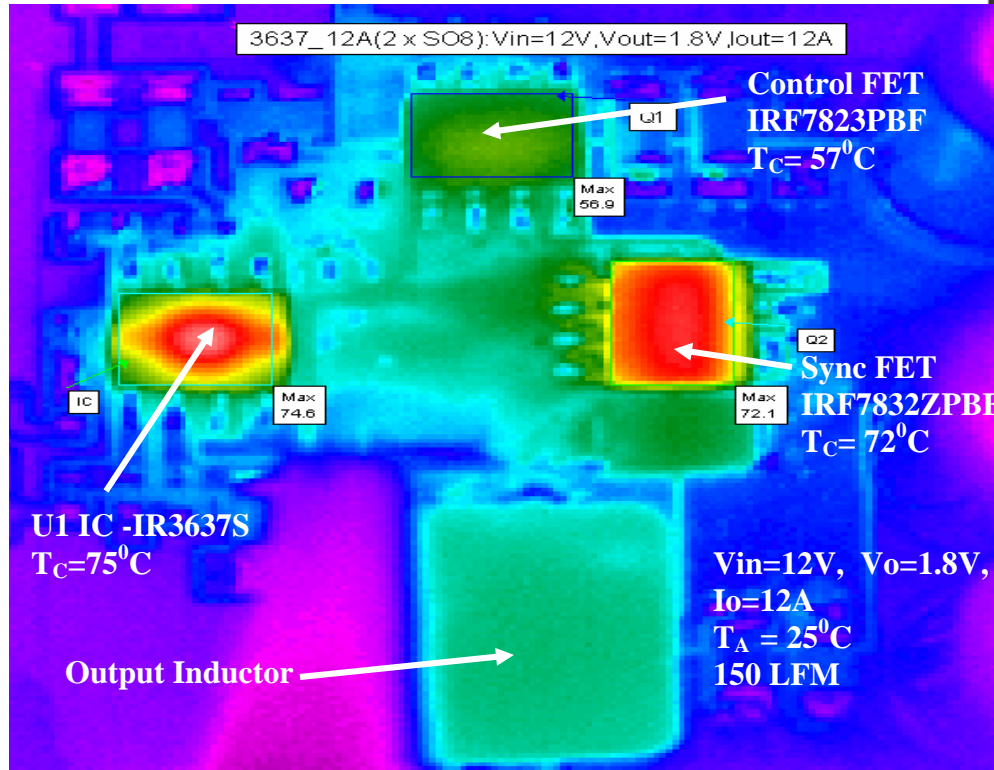

Figure 5: IRPP3637-12A Reference Design Thermograph at 12A load

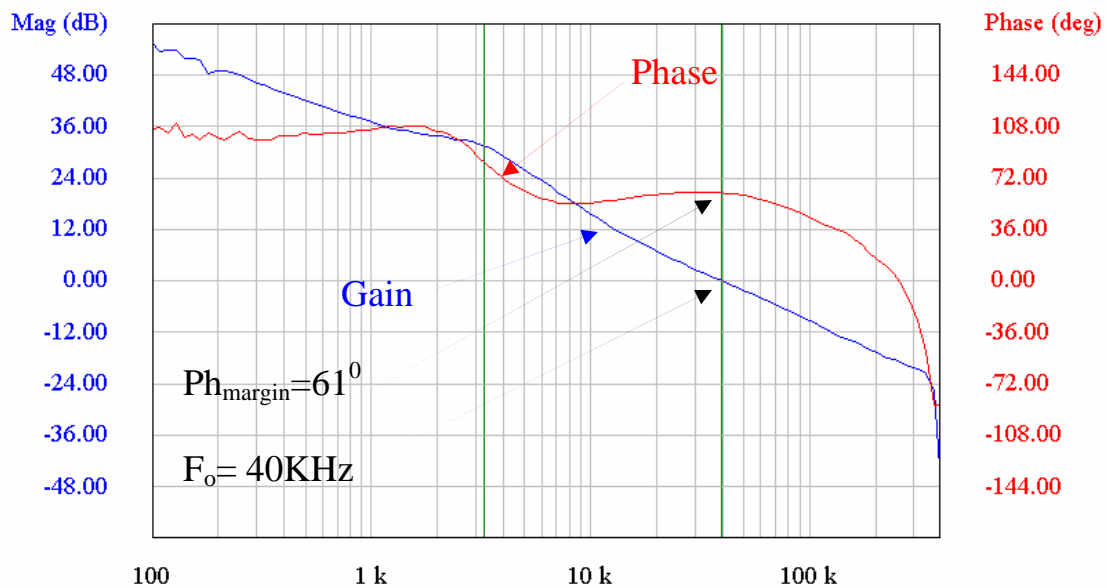

Figure 6: IRPP3637-12A Reference Design Bode Plot of the Control Loop at 12A load.



Figure 7: Input ripple,  $I_o=12A$

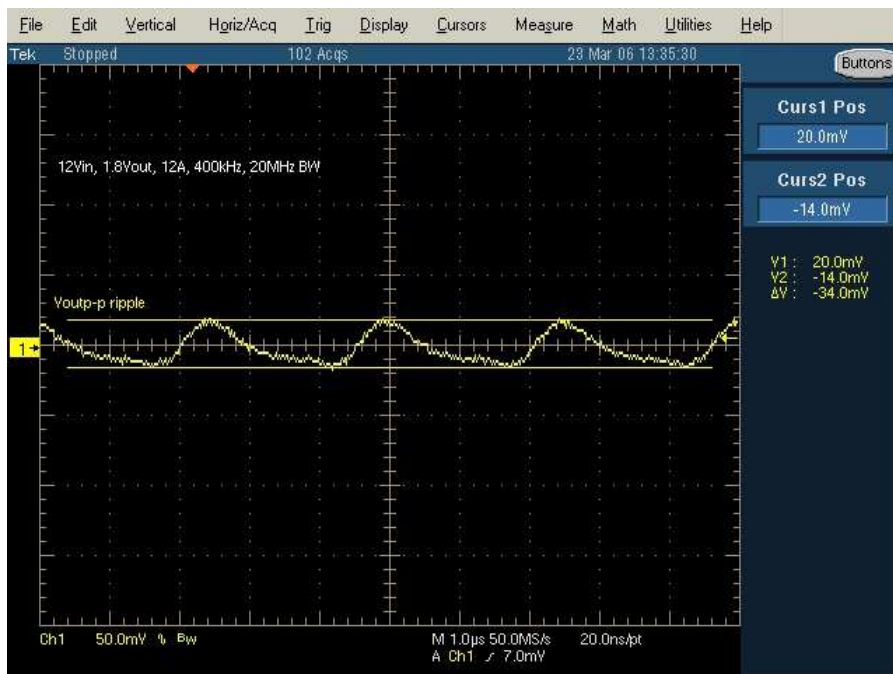

Figure 8: Output ripple,  $I_o=12A$



Figure 9: Output Voltage undershoot due to 1A to 12A load step,  $di/dt=2.5A/\mu s$

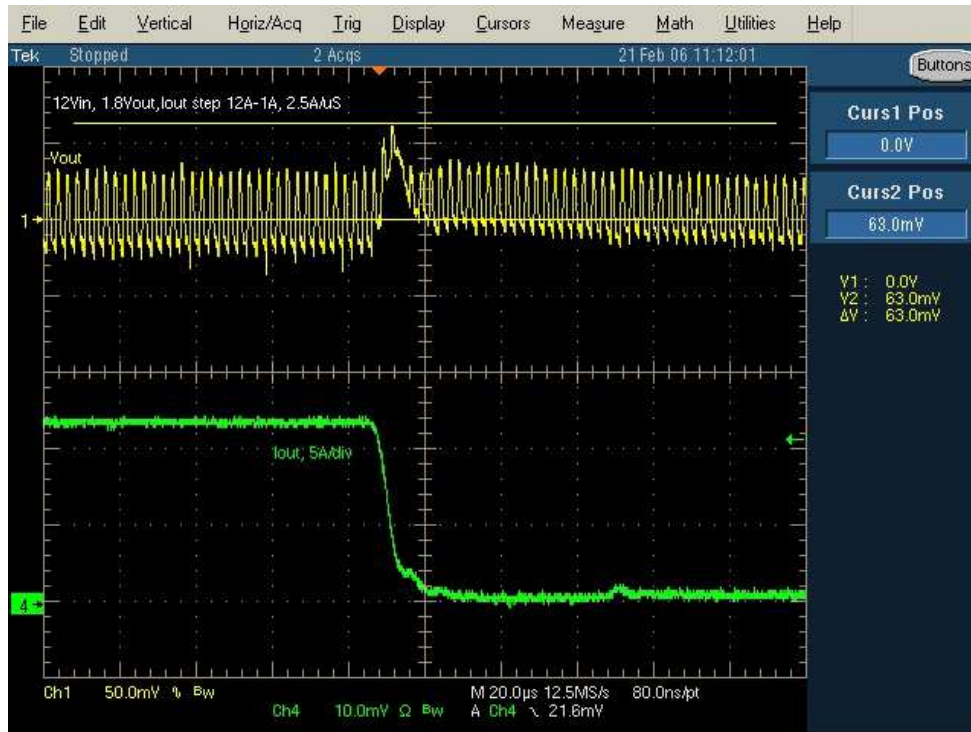

Figure 10: Output Voltage overshoot due to 12A to 1A load step,  $di/dt=2.5A/\mu s$

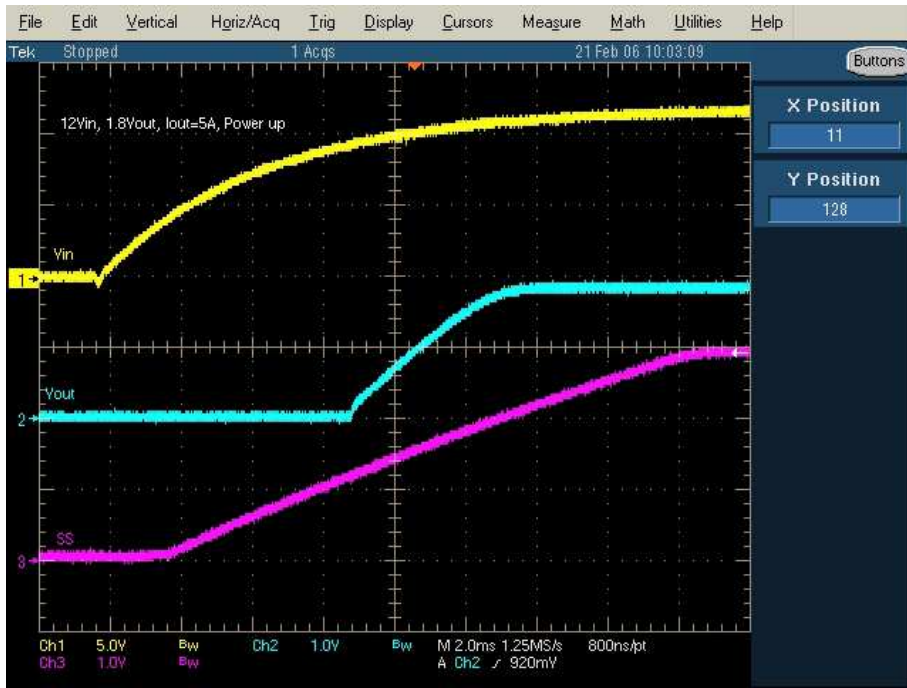

Figure 11: Power up. Ch1= $V_{IN}$ , Ch2= $V_{OUT}$ , Ch3=Soft Start

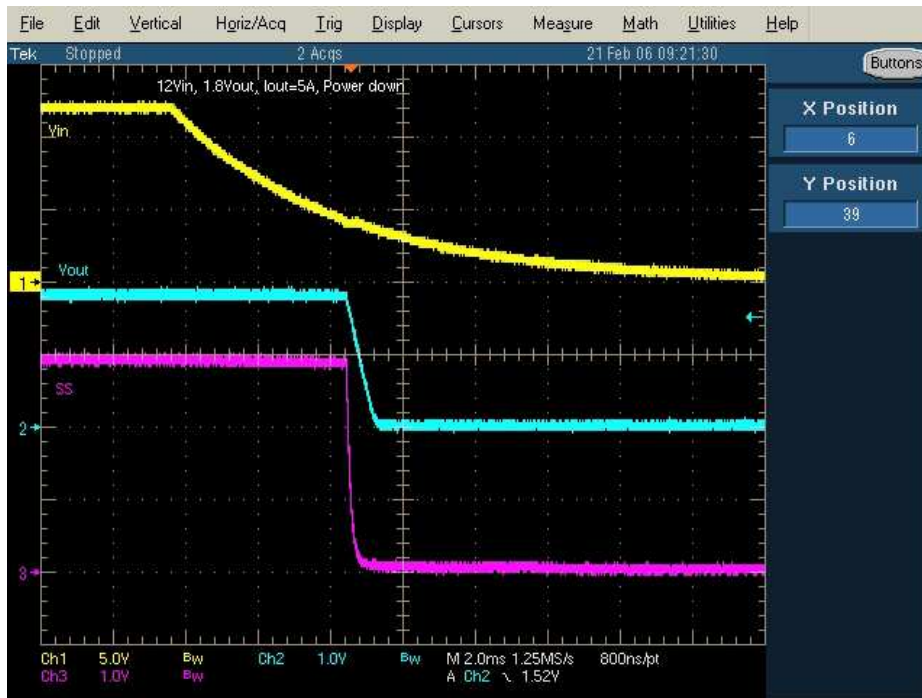

Figure 12: Power down. Ch1= $V_{IN}$ , Ch2= $V_{OUT}$ , Ch3=Soft Start

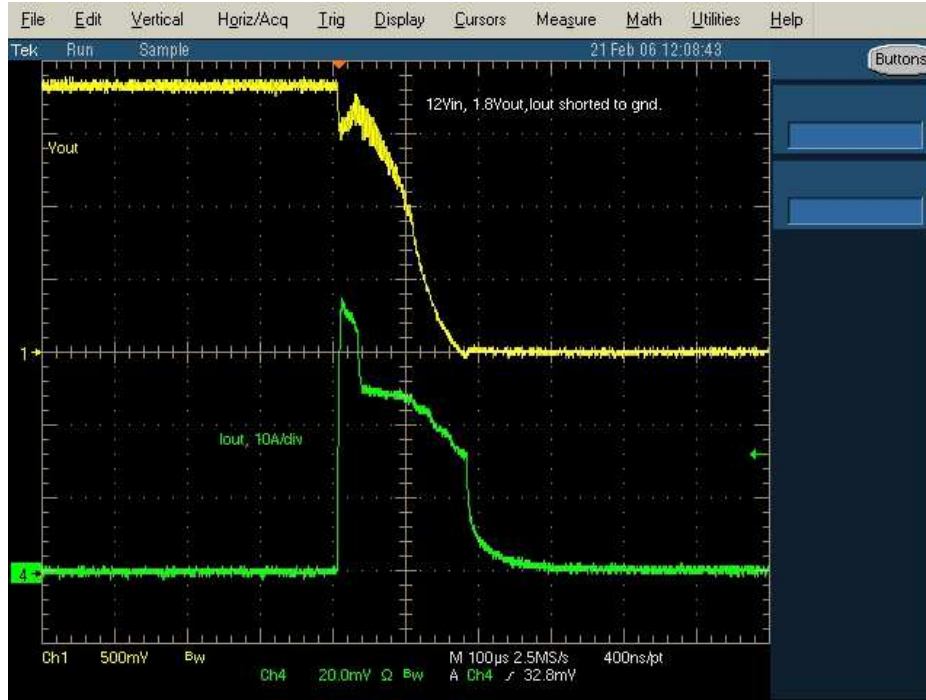

Figure 13: Output short circuit protection. Ch1=V<sub>OUT</sub>, Ch4=I<sub>OUT</sub>10A/div

V <sub>IN</sub> (V)	V <sub>OUT</sub> (V)	I <sub>OUT</sub> (A)	Max Power (W)	Efficiency (%), 25°C, 150 LFM	V <sub>IN</sub> ripple (mVp-p)	V <sub>OUT</sub> Tripple (mVp-p)	Line Regulation (%)	Load Regulation (%)
12V	1.8V	12A	22W	85%	510mV	34mV	0.05%	0.125%

Table 2 – IRPP3637-12A Reference Design Performance Summary (all values are typical)

Part Number	Input Voltage	Output Voltage	Output Current	Switching Frequency	Power Semi BOM	Delivery Time	Comments
IRPP3637-06A	5V	1.25V	6A	600kHz	IR3637AS (SO-8), IRF8910 (Dual SO-8)	24-48hrs	Standard Reference Designs Fixed BOM
IRPP3637-12A	12V	1.8V	12A	400kHz	IR3637S (SO-8), IRF7823 (SO-8), IRF7832Z (SO-8) Option to populate S-Can DirectFETs		
IRPP3637-18A	12V	3.3V	18A	400kHz	IR3637S (SO-8), IRLR8713 (D-Pak), IRLR7843 (D-Pak)		
Custom IRPP3637-06A	3.0V to 13.2V	0.8V to 5.0V	Up to 6A	400kHz or 600kHz	Various	1-2wks	Customizable Reference Designs via POWIR+ Chipset On-line Design Tool at <a href="http://powirplus.irf.com">http://powirplus.irf.com</a>
Custom IRPP3637-12A			Up to 12A				
Custom IRPP3637-18A			Up to 18A				

Table 3 – Complete IRPP3637-xxA Reference Design Selector Table