



# SME900-17

Low Cost Surface Mount Mixer

## Product Features

- RF 820 to 960 MHz
- LO 720 to 940 MHz
- IF 20 to 100 MHz
- High 3IIP: +29 dBm
- LO Drive: +17 dBm
- No Internal Solder Connections

## Product Photo



## Specifications

Parameter	Units	Typical	Guaranteed	
			+25°C	-40° to +70°C
SSB Conversion Loss (Max)	dB	6.2	7.2	7.7
Port-to-Port Isolation (Min)				
L-R	dB	34	27	28
L-I	dB	26	20	21
R-I	dB	32		
3rd Order Input Intercept Point	dBm	29		
VSWR				
R-Port		1.6:1		
L-Port		1.6:1		
I-Port		1.1:1		
1 dB Conversion Compression (Typ)	dBm	+14		

1. Measured in a 50-ohm system with nominal LO drive of +17 dBm, low side LO, and downconverter application only, unless otherwise specified.

2. Measured at RF = 820 MHz, LO = 750 MHz, IF = 70 MHz, unless otherwise specified.

## Absolute Maximum Ratings

Parameter	Rating
Operating Temperature	-40 to +70°C
Storage Temperature	-65 to +100°C
RF Input Power	+27 dBm at +25°C

## Ordering Information

Part No.	Description
SME900-17	Mixer (Available in tape and reel)
SME900-17-PCB	Fully Assembled Application Circuit

## Performance Charts

### IIP3 vs. Frequency

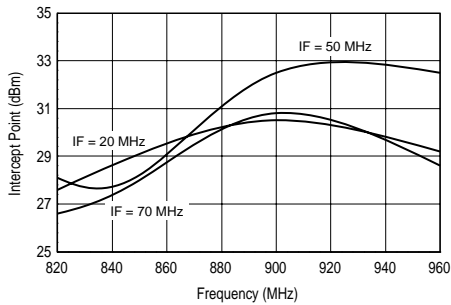

### IIP3 vs. LO Power

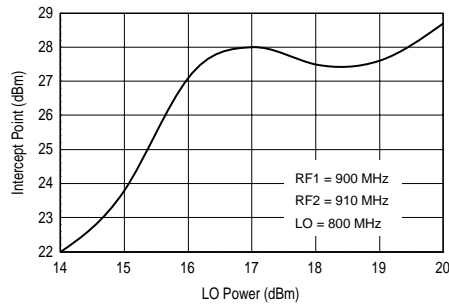

### Conversion Loss vs. Frequency

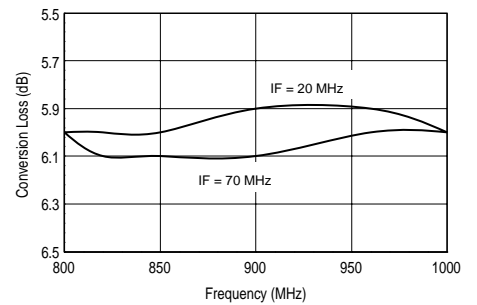

### Conversion Loss vs. RF Power

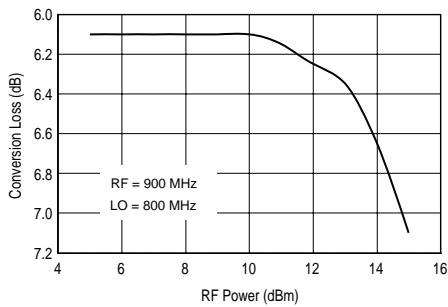

### Conversion Loss vs. LO Power

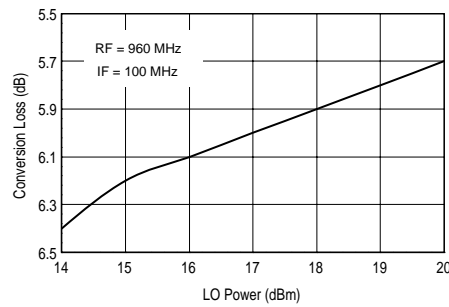

### Conversion Loss vs. Temperature

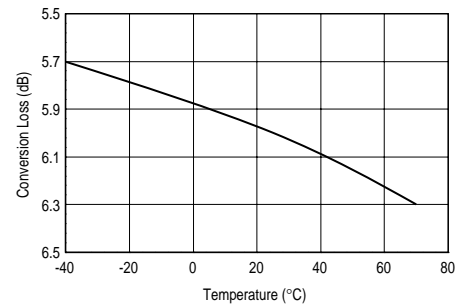

### VSWR vs. Frequency

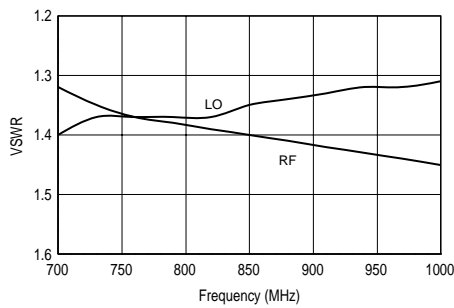

### IF VSWR vs. Frequency

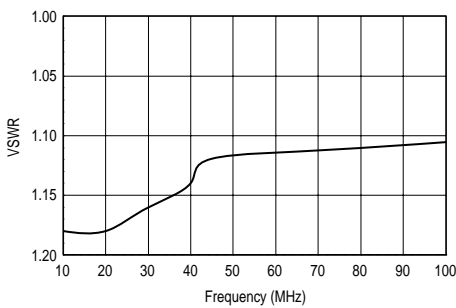

### Isolation vs. Frequency

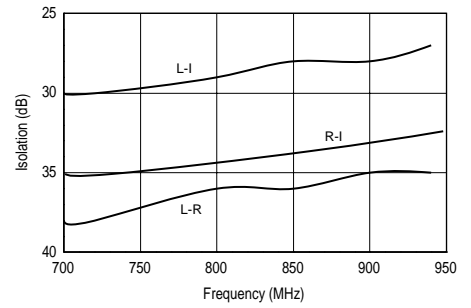

## Single-Tone IM Products

		Harmonics of fLO					
		0	1	2	3	4	5
Harmonics of fRF	0		21	35	44	39	40
	1	25	0	32	14	28	33
	2	65	61	66	74	74	59
	3	>80	>80	>80	>80	>80	77
	4	>80	>80	>80	>80	>80	>80
	5	>80	>80	>80	>80	>80	>80

LO Mult	RF Mult	LO MHz	RF MHz	IM Prod MHz	IM Prod dB
0	1	851	901	901	25
0	2	851	901	1802	65
0	3	851	901	2703	83
0	4	851	901	3604	96
0	5	851	901	4505	96
1	0	831	881	831	21
-1	1	831	881	50	0
1	-2	851	401	49	61
1	-3	851	267	50	82
1	-4	851	199	55	97
-1	5	851	181	54	95
2	0	831	881	1662	35
2	-1	851	1652	50	32
-2	2	826	851	50	66
-2	3	851	584	50	85
-2	4	851	438	50	95
-2	5	851	351	53	96
3	0	831	881	2493	44
-3	1	851	2603	50	14
-3	2	851	1301	49	74
-3	3	851	868	51	81
-3	4	851	651	51	98
-3	5	851	521	52	98
4	0	831	881	3324	39
-4	1	851	3454	50	28
-4	2	851	1727	50	74
-4	3	851	1152	52	84
-4	4	851	864	52	98
-4	5	851	691	51	98
5	0	831	881	4155	40
-5	1	851	4305	50	33
-5	2	851	2152	49	59
-5	3	851	1435	50	77
-5	4	851	1076	49	99
-5	5	851	861	50	95

Test Conditions RF at -10 dBm; LO at +17 dBm

RF harmonics and intermodulation products are referenced to a desired signal produced by fLO = 831 MHz and fRF = 881 MHz.

LO harmonics are referenced to the LO drive signal.

## Outline Drawing

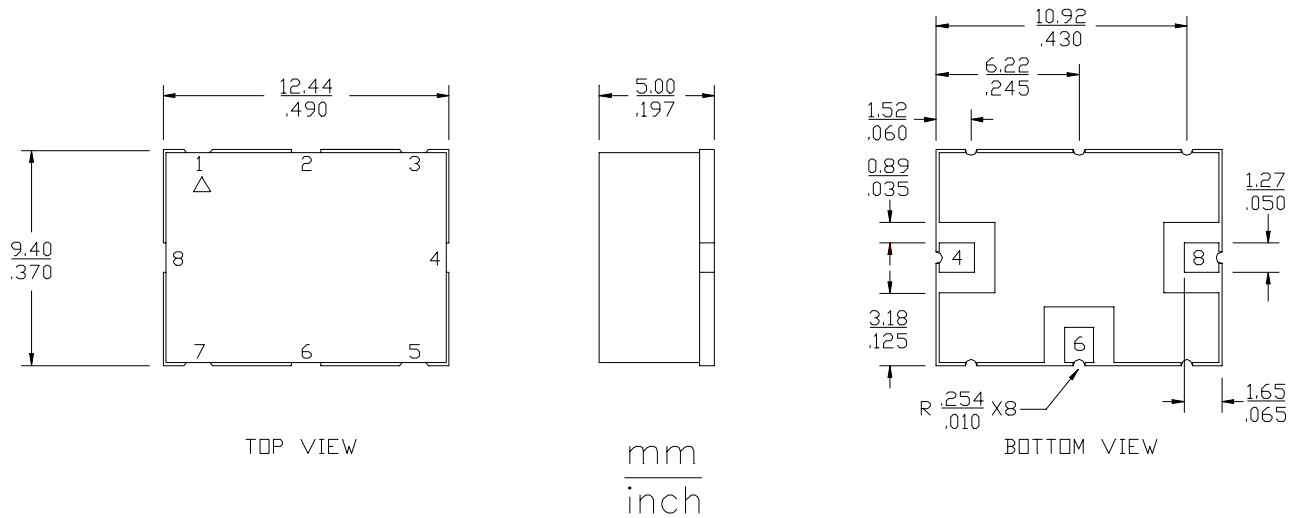

## Land Pattern

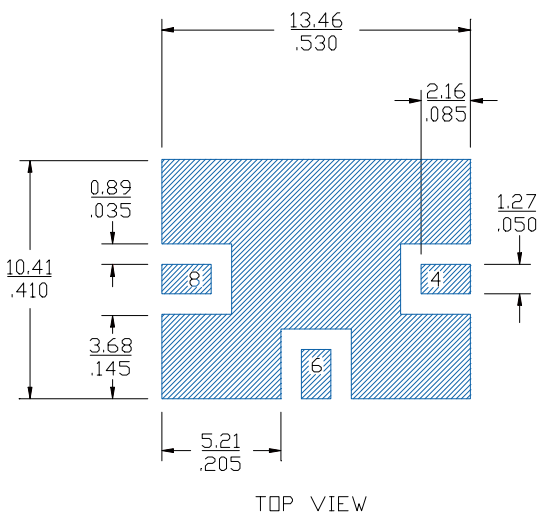

## Mounting Configuration

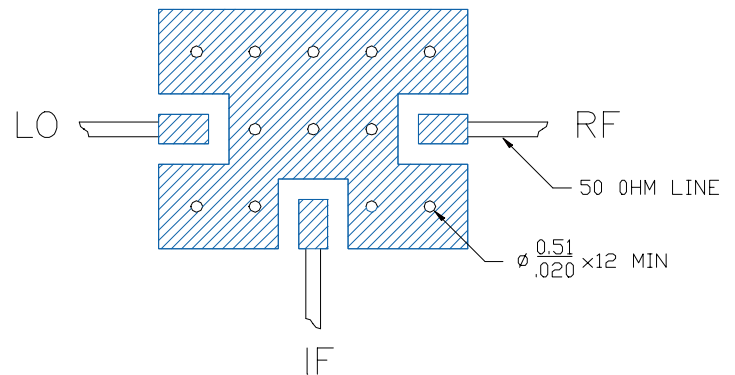

FUNCTION	PIN NO.
GROUND	1-3
RF	4
GROUND	5
IF	6
GROUND	7
LO	8

- Notes:
1. Ground vias are critical for thermal and RF grounding considerations.
  2. A minimum of 12 ground vias are required.
  3. If your PCB design rules allow, ground vias should be placed under the land pattern for better RF and thermal performance. Otherwise ground vias should be placed as close to land pattern as possible.
  4. Trace width depends on PC board.

Specifications and information are subject to change without notice.

