

DC/DC converter

Input 36-72 Vdc

Output up to 15A/60W

- Size 74.7x63.5x11.0 mm (2.94x2.50x0.433 in.)
- Efficiency typ 86% (5 V) at full load
- 1500 Vdc isolation voltage
- MTBF >200 years at +75°C case temperature
- Rugged mechanical design and efficient thermal management, max +100°C case temperature
- EMI measured according to EN 55 022 and FCC part 15J



Safety Approvals



Design for Environment



Meets requirements in high-temperature lead-free soldering processes.

The PKG series of DC/DC converters are members of the EriPower™ range of DC/DC converters for distributed power architectures in 48/60 VDC power systems. They provide up to 60W in single and dual output versions. The PKG units can be used as on-board distributed power modules, or serve as building blocks for more centralized power boards. The high efficiency makes it possible to operate over a wide temperature range without any extra heatsinks. At forced convection cooling >200 lfm (1 m/s), the PKG units can deliver full power without heatsinks up to +65°C ambient. With derated output power it can also operate in temperature controlled environments with

non-forced convection cooling. By adding external heatsinking, the temperature range can be extended even further. Thanks to its peak power capability, the PKG series is ideal for applications where max power is only required during short durations e.g. in disc drives. The PKG series uses ceramic substrates with plated copper in order to achieve good thermal management. These products are manufactured using highly automated manufacturing lines with a world-class quality commitment. Ericsson Power Modules AB is an ISO 9001/14001 certified supplier.

General

Absolute Maximum Ratings

Characteristics		min	max	Unit
T _C	Case temperature @ max output power	-45	+100	°C
T _S	Storage temperature	-55	+125	°C
V _I	Input voltage	-0.5	+80	V dc
V _{ISO}	Isolation voltage (input to output test voltage)	1500		V dc
V _{RC}	Remote control voltage pin 1	-10	+10	Vdc
V _{adj}	Output adjust voltage pin 10	-10	+10	Vdc

Stress in excess of Absolute Maximum Ratings may cause permanent damage. Absolute Maximum Ratings, sometimes referred to as no destruction limits, are normally tested with one parameter at a time exceeding the limits of Output data or Electrical Characteristics. If exposed to stress above these limits, function and performance may degrade in an unspecified manner.

Input T_C < T_C max

Characteristics		Conditions	min	typ	max	Unit
V _I	Input voltage range ¹⁾		36		72	V
V _{Ioff}	Turn-off input voltage			32		V
V _{Ion}	Turn-on input voltage			33		V
r _{Irush}	Equivalent inrush current resistance			30		mΩ
C _I	Input capacitance			1.8		μF
P _{Ii}	Input idling power	I _o =0, T _C = -30...+90 °C		1.5	2.0	W
P _{RC}	Input stand-by current	V _I = 53 V, T _C = +25 °C RC connected to pin 4		1.0		W

Environmental Characteristics

Characteristics	Test procedure & conditions		
Vibration (Sinusoidal)	IEC 68-2-6 F _C	Frequency Amplitude Acceleration Number of cycles	10...500 Hz 0.75 mm 10 g 10 in each axis
Random vibration	IEC 68-2-34 E _d	Frequency Acceleration density spectrum Duration Reproducibility	10...500 Hz 0.5 g ² /Hz 10 min in 3 directions medium (IEC 62-2-36)
Shock (Half sinus)	IEC 68-2-27 E _a	Peak acceleration Shock duration	200 g 3 ms
Temperature change	IEC 68-2-14 N _a	Temperature Number of cycles	-40°C...+125°C 100
Accelerated damp heat	IEC 68-2-3 C _a with bias	Temperature Humidity Duration	85°C 85% RH 1000 hours
Solder resistability	IEC 68-2-20 T _b 1A	Temperature, solder Duration	260°C 10...13 s
Resistance to cleaning solvents	IEC 68-2-45 XA Method 1	Water Isopropyl alcohol Terpens Method	+55 ±5°C +35 ±5°C +35 ±5°C with rubbing

Safety

The PKG 4000 I Series DC/DC converters are designed in accordance with EN 60 950 *Safety of information technology equipment including electrical business equipment* and certified by SEMKO. The isolation is an operational insulation in accordance with EN 60950.

The PKG DC/DC converter are re-cognized by UL and meet the applicable requirements in UL 1950 *Safety of information technology equipment*, the applicable Canadian safety requirements and UL 1012 *Standard for power supplies*.

The DC/DC converter shall be installed in an end-use equipment and is intended to be supplied by isolated secondary circuitry and shall be installed in compliance with the requirements of the ultimate application. When the supply to the DC/DC converter meets all the requirements for SELV (<60Vdc), the output is considered to remain within SELV limits (level 3). If connected to a 60 V DC power system reinforced insulation must be provided in the power supply that isolates the input from the ac mains. Single fault testing in the power supply must be performed in combination with the DC/DC converter to demonstrate that the output meets the requirement for SELV. One pole of the input and one pole of the output is to be grounded or both are to be kept floating. The terminal pins are only intended for connection to mating connectors of internal wiring inside the end-use equipment.

These DC/DC converters may be used in telephone equipment in accordance with paragraph 34 A.1 of UL 1459 (Standard for Telephone Equipment, second edition). The isolation voltage is a galvanic isolation and is verified in an electric strength test. Test voltage between input and output and between case and output is 1,500 V dc for 60 s. In production the test duration may be decreased to 1 s. The capacitor between input and output has a value of 4.7 nF (duals = 22 nF) and the leakage current is less than 1μA @ 50 Vdc.

Flammability ratings of the terminal support and internal plastic construction details meets UL 94V-0.

Note:

¹⁾ The input voltage range 36...72 V meets the requirements in the European Telecom Standard prETS 300 132-2 for Normal input voltage range in 48 V and 60 V DC power systems, -40.5...-57.0 V and -50.0...-72.0 V respectively. At input voltages exceeding 72 V (abnormal voltage) the power loss will be higher than at normal input voltage and T_C must be limited to max +90°C. Absolute max continuous input voltage is 80 Vdc. Output characteristics will be marginally affected at input voltages exceeding 72 V.

Mechanical Data

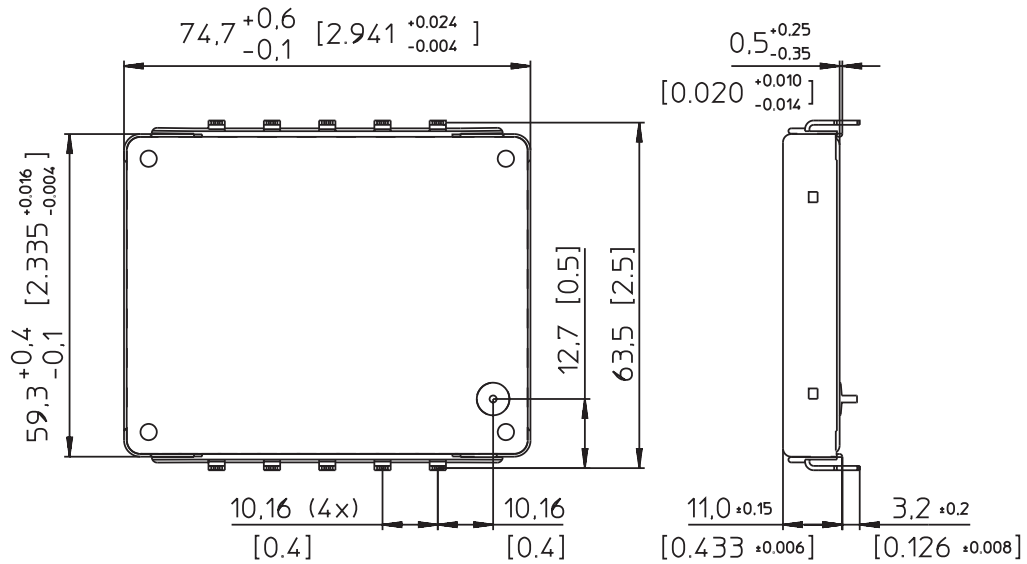

Recommended foot print

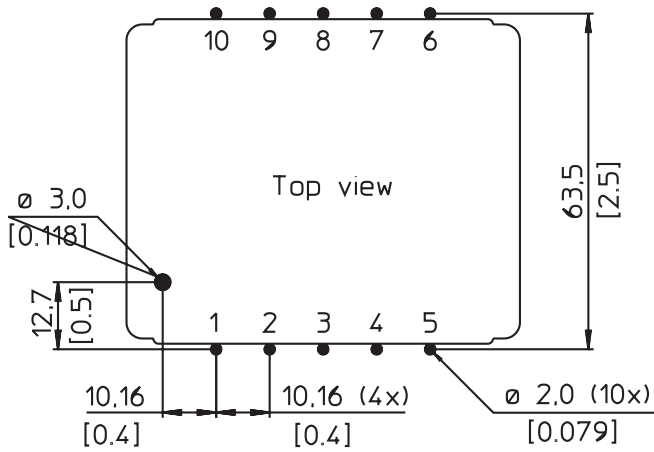

Dimensions in mm (in)

Connections

Pin	Designation	Function
1	RC	Remote control for turn-on and off.
2	NC	Not connected.
3	+In	Positive input. Connected to case.
4	-In	Negative input.
5	NC	Not connected.
6	-Out 2	Negative output 2.
7	+Out 2	Positive output 2.
8	-Out 1	Negative output 1.
9	+Out 1	Positive output 1.
10	V _{adj}	Output voltage adjust.

Weight

Maximum 75 g (2.66 oz).

Case

Blue anodized aluminium casing with embedded palladium plated copper pins.

Thermal Data

Two-parameter model

Power dissipation is generated in the components mounted on the ceramic substrate. The thermal properties of the PKG DC/DC converter is determined by thermal conduction in the connected pins and thermal convection from the substrate via the case.

The two-parameter model characterizes the thermal properties of the PKG DC/DC converter and the equation below can be used for thermal design purposes if detailed information is needed. The values are given for a module mounted on a printed board assembly (PBA).

Note that the thermal resistance between the substrate and the air,

$R_{th\ sub-A}$ is strongly dependent on the air velocity.

$$T_{sub} = P_d \times R_{th\ sub-P} \times R_{th\ sub-A} / (R_{th\ sub-P} + R_{th\ sub-A}) + (T_P - T_A) \times R_{th\ sub-A} / (R_{th\ sub-P} + R_{th\ sub-A}) + T_A$$

Where:

- P_d : dissipated power, calculated as $P_O \times (1/\eta - 1)$
- T_{sub} : max average substrate temperature, $\approx T_{C,max}$
- T_A : ambient air temperature at the lower side of the power module
- T_P : average pin temperature at the PB solder joint
- $R_{th\ sub-P}$: thermal resistance from T_{sub} to the pins
- $R_{th\ sub-A}$: thermal resistance from T_{sub} to T_A
- v : velocity of ambient air.

Air velocity in free convection is 0.2–0.3 m/s (40-60 lfm).

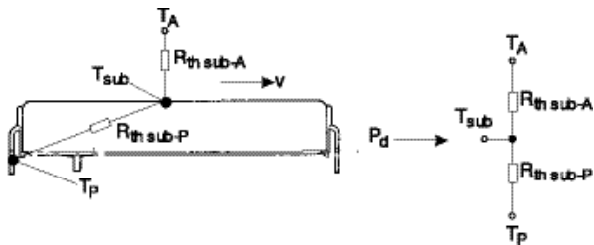
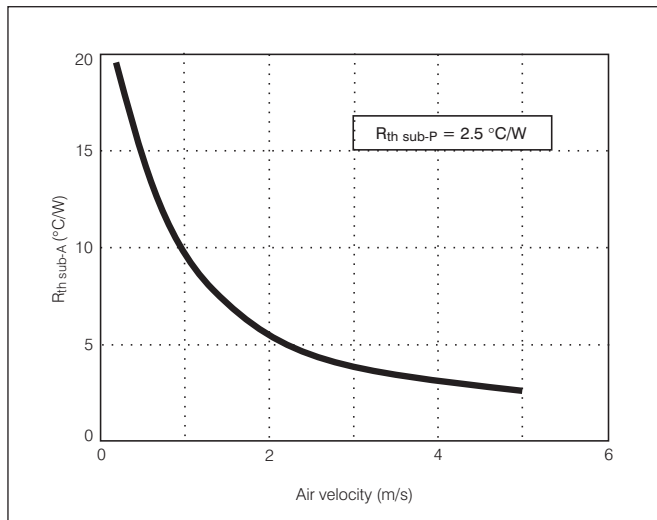

Over Temperature Protection (OTP)

The PKG DC/DC converters have an internal over temperature protection circuit. If the case temperature exceeds min +115°C the power module will go in to OTP-mode. As long as the case temperature exceeds min +115°C the power module will operate in OTP-mode.

During the OTP-mode the DC/DC converter will shut down completely and when the case temperature has decreased 25°C the converter will automatically restart.

Electrical Data

Fundamental circuit diagrams

Single output

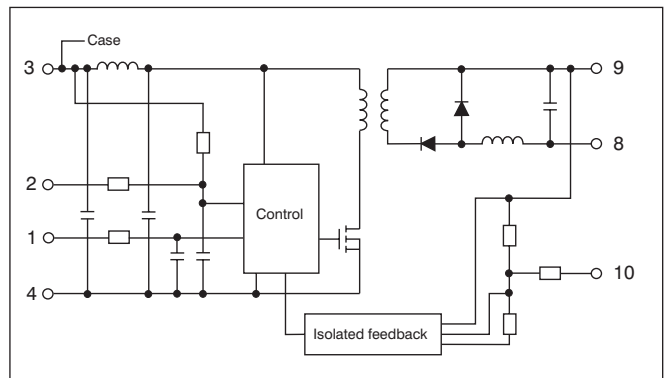

Dual output

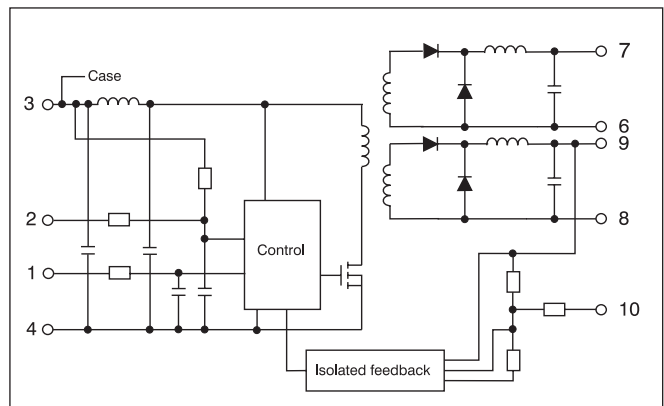

PKG 4319 PI

$T_C = -30...+90^{\circ}\text{C}$, $V_I = 36 \dots 72\text{V}$ unless otherwise specified.

Output

Characteristics		Conditions		Output 1			Unit
				min	typ	max	
V_{O_i}	Output voltage initial setting and accuracy	$T_C = +25^{\circ}\text{C}$, $I_O = 15\text{ A}$, $V_I = 53\text{ V}$		2.49	2.51	2.53	V
	Output adjust range ¹⁾			2.25		2.75	V
V_O	Output voltage tolerance band	Long term drift included	$I_O = 0.1 \dots 1.0 \times I_{O_{\text{max}}}$	2.43		2.57	V
	Idling voltage	$I_O = 0\text{ A}$				4.0	V
	Line regulation	$I_O = I_{O_{\text{max}}}$	$V_I = 36 \dots 60\text{ V}$	5			mV
			$V_I = 50 \dots 72\text{ V}$	5			
	Load regulation	$I_O = 0.1 \dots 1.0 \times I_{O_{\text{max}}}$, $V_I = 53\text{ V}$		30			mV
t_{tr}	Load transient recovery time	$I_O = 0.1 \dots 1.0 \times I_{O_{\text{max}}}$, $V_I = 53\text{ V}$ load step = $0.5 \times I_{O_{\text{max}}}$		100			μs
V_{tr}	Load transient voltage			+250			mV
				-500			mV
T_{coeff}	Temperature coefficient ²⁾	$I_O = I_{O_{\text{max}}}$, $T_C < T_{C_{\text{max}}}$		see PKG 4319 PI Temperature characteristics			
t_r	Ramp-up time	$I_O = 0.1 \dots 1.0 \times I_{O_{\text{max}}}$ $V_I = 53\text{ V}$	$0.1 \dots 0.9 \times V_O$	30			ms
t_s	Start-up time		From V_I connection to $V_O = 0.9 \times V_{O_i}$	60			ms
I_O	Output current			0		15	A
$P_{O_{\text{max}}}$	Max output power ³⁾	Calculated value		38			W
I_{lim}	Current limiting threshold	$T_C < T_{C_{\text{max}}}$		15.3			A
I_{sc}	Short circuit current	$V_O = 0.2 \dots 0.5\text{ V}$, $T_A = 25^{\circ}\text{C}$, $R_{\text{SC}} > 25\text{ m}\Omega$		22			A
$V_{O_{\text{ac}}}$	Output ripple	$I_O = I_{O_{\text{max}}}$	20 Hz...5 MHz	60		100	mV _{p-p}
SVR	Supply voltage rejection (ac)	$f = 100\text{ Hz}$ sine wave, 1 V_{p-p} , $V_I = 53\text{ V}$ ($\text{SVR} = 20 \log(1 \text{ V}_{p-p}/V_{O_{p-p}})$)		47			dB
OVP	Over voltage protection	$I_O > 0.1 \times I_{O_{\text{max}}}$		4.2			V

¹⁾ See Operating information.

²⁾ Temperature coefficient is positive at low temperatures and negative at high temperatures.

³⁾ See also Typical Characteristics, Power derating.

Miscellaneous

Characteristics		Conditions	min	typ	max	Unit
η	Efficiency	$I_O = I_{O_{\text{max}}}$, $V_I = 53\text{ V}$		78		%
P_d	Power dissipation	$I_O = I_{O_{\text{max}}}$, $V_I = 53\text{ V}$		10.7		W

PKG 4410 PI

$T_C = -30 \dots +90^\circ\text{C}$, $V_I = 36 \dots 72\text{V}$ unless otherwise specified.

Output

Characteristics		Conditions		Output 1			Unit
				min	typ	max	
V_{O_i}	Output voltage initial setting and accuracy	$T_C = +25^\circ\text{C}$, $I_O = 14\text{A}$, $V_I = 53\text{V}$		3.27	3.30	3.34	V
	Output adjust range ¹⁾			2.80		3.65	V
V_O	Output voltage tolerance band	Long term drift included	$I_O = 0.1 \dots 1.0 \times I_{O_{\text{max}}}$	3.10		3.40	V
	Idling voltage	$I_O = 0\text{A}$				4.0	V
	Line regulation	$I_O = I_{O_{\text{max}}}$	$V_I = 36 \dots 60\text{V}$	3			mV
			$V_I = 50 \dots 72\text{V}$	3			
	Load regulation	$I_O = 0.1 \dots 1.0 \times I_{O_{\text{max}}}$, $V_I = 53\text{V}$		35			mV
t_{tr}	Load transient recovery time	$I_O = 0.1 \dots 1.0 \times I_{O_{\text{max}}}$, $V_I = 53\text{V}$ load step = $0.5 \times I_{O_{\text{max}}}$		100			μs
V_{tr}	Load transient voltage			+200			mV
				-330			mV
T_{coeff}	Temperature coefficient ²⁾	$I_O = I_{O_{\text{max}}}$, $T_C < T_{C_{\text{max}}}$		see PKG 4410 PI Temperature characteristics			
t_r	Ramp-up time	$I_O = 0.1 \dots 1.0 \times I_{O_{\text{max}}}$ $V_I = 53\text{V}$	$0.1 \dots 0.9 \times V_O$	10			ms
t_s	Start-up time		From V_I connection to $V_O = 0.9 \times V_{O_i}$	20			ms
I_O	Output current			0		14	A
$P_{O_{\text{max}}}$	Max output power ³⁾	Calculated value		46			W
I_{lim}	Current limiting threshold	$T_C < T_{C_{\text{max}}}$		15.4			A
I_{sc}	Short circuit current	$V_O = 0.2 \dots 0.5\text{V}$, $T_A = 25^\circ\text{C}$		18			A
$V_{O_{\text{ac}}}$	Output ripple	$I_O = I_{O_{\text{max}}}$	20 Hz ... 5 MHz	60		100	mV _{p-p}
SVR	Supply voltage rejection (ac)	$f = 100\text{Hz}$ sine wave, $1 V_{p-p}$, $V_I = 53\text{V}$ (SVR = $20 \log(1 V_{p-p}/V_{O_{p-p}})$)		65			dB
OVP	Over voltage protection	$I_O > 0.1 \times I_{O_{\text{max}}}$		4			V

1) See Operating information.

2) Temperature coefficient is positive at low temperatures and negative at high temperatures.

3) See also Typical Characteristics, Power derating.

Miscellaneous

Characteristics		Conditions		min	typ	max	Unit
η	Efficiency	$I_O = I_{O_{\text{max}}}$, $V_I = 53\text{V}$			81		%
P_d	Power dissipation	$I_O = I_{O_{\text{max}}}$, $V_I = 53\text{V}$			11		W

PKG 4611 PI

$T_C = -30 \dots +90^\circ\text{C}$, $V_I = 36 \dots 72\text{V}$ unless otherwise specified.

Output

Characteristics		Conditions		Output 1			Unit
				min	typ	max	
V_{O_i}	Output voltage initial setting and accuracy	$T_C = +25^\circ\text{C}$, $I_O = 12\text{A}$, $V_I = 53\text{V}$		5.12	5.15	5.18	V
	Output adjust range ¹⁾			4.65		5.65	V
V_O	Output voltage tolerance band	Long term drift included	$I_O = 0.1 \dots 1.0 \times I_{O_{\text{max}}}$	5.00		5.20	V
	Idling voltage	$I_O = 0\text{A}$				5.9	V
	Line regulation	$I_O = I_{O_{\text{max}}}$	$V_I = 36 \dots 60\text{V}$	5			mV
			$V_I = 50 \dots 72\text{V}$	5			
	Load regulation	$I_O = 0.1 \dots 1.0 \times I_{O_{\text{max}}}$, $V_I = 53\text{V}$		50			mV
t_{tr}	Load transient recovery time	$I_O = 0.1 \dots 1.0 \times I_{O_{\text{max}}}$, $V_I = 53\text{V}$ load step = $0.5 \times I_{O_{\text{max}}}$		100			μs
V_{tr}	Load transient voltage			+350			mV
		-500			mV		
T_{coeff}	Temperature coefficient ²⁾	$I_O = I_{O_{\text{max}}}$, $T_C < T_{C_{\text{max}}}$		see PKG 4611 PI Temperature characteristics			
t_r	Ramp-up time	$I_O = 0.1 \dots 1.0 \times I_{O_{\text{max}}}$ $V_I = 53\text{V}$	$0.1 \dots 0.9 \times V_O$	10			ms
t_s	Start-up time		From V_I connection to $V_O = 0.9 \times V_{O_i}$	20			ms
I_O	Output current			0		12	A
$P_{O_{\text{max}}}$	Max output power ³⁾	Calculated value		60			W
I_{lim}	Current limiting threshold	$T_C < T_{C_{\text{max}}}$		12.1			A
I_{sc}	Short circuit current	$V_O = 0.2 \dots 0.5\text{V}$, $T_A = 25^\circ\text{C}$		13			A
$V_{O_{\text{ac}}}$	Output ripple	$I_O = I_{O_{\text{max}}}$	20 Hz ... 5 MHz	60		100	mV _{p-p}
SVR	Supply voltage rejection (ac)	$f = 100\text{Hz}$ sine wave, 1V_{p-p} , $V_I = 53\text{V}$ (SVR = $20 \log(1 \text{V}_{p-p}/V_{O_{p-p}})$)		50			dB
OVP	Over voltage protection	$I_O > 0.1 \times I_{O_{\text{max}}}$		6			V

¹⁾ See Operating information.

²⁾ Temperature coefficient is positive at low temperatures and negative at high temperatures.

³⁾ See also Typical Characteristics, Power derating.

Miscellaneous

Characteristics		Conditions	min	typ	max	Unit
η	Efficiency	$I_O = I_{O_{\text{max}}}$, $V_I = 53\text{V}$		85.5		%
P_d	Power dissipation	$I_O = I_{O_{\text{max}}}$, $V_I = 53\text{V}$		10		W

PKG 4617 PIOA

$T_C = -30...+90^{\circ}\text{C}$, $V_I = 36 \dots 72\text{V}$ unless otherwise specified.

Output

Characteristics		Conditions		Output 1			Unit
				min	typ	max	
V_{O_i}	Output voltage initial setting and accuracy	$T_C = +25^{\circ}\text{C}$, $I_O = 10\text{A}$, $V_I = 53\text{V}$		6.10	6.22	6.40	V
	Output adjust range ¹⁾			5.0		7.7	V
V_O	Output voltage tolerance band	Long term drift included	$I_O = 0.1 \dots 1.0 \times I_{O_{\text{max}}}$	6.00		6.40	V
	Idling voltage	$I_O = 0\text{A}$				7.5	V
	Line regulation	$I_O = I_{O_{\text{max}}}$	$V_I = 36 \dots 60\text{V}$	2			mV
			$V_I = 50 \dots 72\text{V}$	2			
	Load regulation	$I_O = 0.1 \dots 1.0 \times I_{O_{\text{max}}}$, $V_I = 53\text{V}$		15			mV
t_{tr}	Load transient recovery time	$I_O = 0.1 \dots 1.0 \times I_{O_{\text{max}}}$, $V_I = 53\text{V}$ load step = $0.5 \times I_{O_{\text{max}}}$		100			μs
V_{tr}	Load transient voltage			+150			mV
				-200			mV
T_{coeff}	Temperature coefficient ²⁾	$I_O = I_{O_{\text{max}}}$, $T_C < T_{C_{\text{max}}}$		see PKG 4617 PIOA Temperature characteristics			
t_r	Ramp-up time	$I_O = 0.1 \dots 1.0 \times I_{O_{\text{max}}}$ $V_I = 53\text{V}$	$0.1 \dots 0.9 \times V_O$	12			ms
t_s	Start-up time		From V_I connection to $V_O = 0.9 \times V_{O_i}$	15			ms
I_O	Output current			0		10	A
$P_{O_{\text{max}}}$	Max output power ³⁾	Calculated value		60			W
I_{lim}	Current limiting threshold	$T_C < T_{C_{\text{max}}}$		11.6			A
I_{sc}	Short circuit current	$V_O = 0.2 \dots 0.5\text{V}$, $T_A = 25^{\circ}\text{C}$		15			A
$V_{O_{\text{ac}}}$	Output ripple	$I_O = I_{O_{\text{max}}}$	20 Hz ... 5 MHz	60		100	mV _{p-p}
SVR	Supply voltage rejection (ac)	$f = 100\text{Hz}$ sine wave, $1 V_{p-p}$, $V_I = 53\text{V}$ ($\text{SVR} = 20 \log(1 V_{p-p}/V_{O_{p-p}})$)		60			dB
OVP	Over voltage protection	$I_O > 0.1 \times I_{O_{\text{max}}}$		8			V

1) See Operating information.

2) Temperature coefficient is positive at low temperatures and negative at high temperatures.

3) See also Typical Characteristics, Power derating.

Miscellaneous

Characteristics		Conditions		min	typ	max	Unit
η	Efficiency	$I_O = I_{O_{\text{max}}}$, $V_I = 53\text{V}$			84		%
P_d	Power dissipation	$I_O = I_{O_{\text{max}}}$, $V_I = 53\text{V}$			11		W

PKG 4428 PI

$T_C = -30...+90^{\circ}\text{C}$, $V_I = 36...72\text{V}$ unless otherwise specified. $I_{O1\text{ nom}} = 6.0\text{ A}$, $I_{O2\text{ nom}} = 4.0\text{ A}$.

Output

Characteristics		Conditions		Output 1			Output 2			Unit
				min	typ	max	min	typ	max	
V_{O1}	Output voltage initial setting and accuracy	$T_C = +25^{\circ}\text{C}$, $I_O = I_{O\text{ nom}}$, $V_I = 53\text{ V}$		3.27	3.30	3.33	5.10	5.27	5.40	V
	Output adjust range ¹⁾			2.90		3.70		4.60		5.90
V_O	Output voltage tolerance band	Long term drift included	$I_O = 0.2...1.0 \times I_{O\text{ nom}}$ $I_{O1} = 1.5 \times I_{O2}$	3.10		3.40		4.90	5.40	V
	Idling voltage	$I_O = 0\text{ A}$		4.0			7.0		V	
	Line regulation	$I_O = I_{O\text{ nom}}$	$V_I = 36...60\text{ V}$	5		15			mV	
			$V_I = 50...72\text{ V}$	5		15				
	Load regulation	$I_{O1} = 0.1...1.0 \times I_{O1\text{ nom}}$, $I_{O2} = I_{O2\text{ nom}}$, $V_I = 53\text{ V}$		15						mV
t_{tr}	Load transient recovery time	$I_O = 0.1...1.0 \times I_{O1\text{ nom}}$, $V_I = 53\text{ V}$ load step = $0.5 \times I_{O1\text{ nom}}$, $I_{O2} = I_{O2\text{ nom}}$		100			100			μs
V_{tr}	Load transient voltage			+150			+150			mV
				-200			-200			mV
T_{coeff}	Temperature coefficient ²⁾	$I_O = I_{O\text{ nom}}$, $T_C < T_{C\text{ max}}$		see PKG 4428 PI Temperature characteristics						
t_r	Ramp-up time	$I_O = 0.1...1.0 \times I_{O\text{ max}}$ $V_I = 53\text{ V}$	$0.1...0.9 \times V_O$	12		12			ms	
t_s	Start-up time		From V_I connection to $V_O = 0.9 \times V_{O1}$	15		15			ms	
I_O	Output current			0	9.6		⁰⁴⁾	6.4		A
$P_{O\text{ max}}$	Max total output power ³⁾	Calculated value		min 40					W	
I_{lim}	Current limiting threshold	$T_C < T_{C\text{ max}}$		min $1.02 \times P_{O\text{ max}}^5)$						
I_{sc}	Short circuit current	$V_O = 0.2... 0.5\text{ V}$, $T_A = 25^{\circ}\text{C}$, $R_{\text{SC}} > 0.1\ \Omega$		15					A	
$V_{O\text{ ac}}$	Output ripple	$I_O = I_{O\text{ nom}}$	20 Hz...5 MHz	100	150		100	150		mV _{p-p}
SVR	Supply voltage rejection (ac)	$f = 100\text{ Hz}$ sine wave, 1 V_{p-p} , $V_I = 53\text{ V}$ ($\text{SVR} = 20 \log(1\text{ V}_{p-p}/V_{O\text{ p-p}})$)		60		60			dB	
OVP	Over voltage protection	$I_O > 0.1 \times I_{O\text{ max}}$		4						V

¹⁾ See Operating information.

²⁾ Temperature coefficient is positive at low temperatures and negative at high temperatures.

³⁾ See also Typical Characteristics, Power derating.

⁴⁾ At full load on output 1 output 2 must have min 0.6 A load.

⁵⁾ I_{lim} on each output is set by the total load.

Miscellaneous

Characteristics		Conditions	min	typ	max	Unit
η	Efficiency	$I_O = I_{O\text{ nom}}$, $V_I = 53\text{ V}$		84		%
P_d	Power dissipation	$I_O = I_{O\text{ nom}}$, $V_I = 53\text{ V}$		7.6		W

PKG 4623 PI

$T_C = -30 \dots +90^\circ\text{C}$, $V_I = 36 \dots 72\text{V}$ unless otherwise specified. $I_{O1 \text{ nom}} = 2.5 \text{ A}$, $I_{O2 \text{ nom}} = 2.5 \text{ A}$.

Output

Characteristics		Conditions		Output 1			Output 2			Unit
				min	typ	max	min	typ	max	
V_{O_i}	Output voltage initial setting and accuracy	$T_C = +25^\circ\text{C}$, $I_O = I_{O \text{ nom}}$, $V_I = 53 \text{ V}$		11.94	12.10	12.26	11.94	12.10	12.26	V
	Output adjust range ¹⁾			10.80		13.20	10.80		13.20	V
V_O	Output voltage tolerance band	Long term drift included	$I_O = 0.1 \dots 1.0 \times I_{O \text{ nom}}$ $I_{O1} = I_{O2}$	11.70		12.50	11.70		12.60	V
	Idling voltage	$I_O = 0 \text{ A}$				13.35			20	V
	Line regulation	$I_O = I_{O \text{ nom}}$	$V_I = 36 \dots 60 \text{ V}$	10			10			mV
			$V_I = 50 \dots 72 \text{ V}$	10			10			
	Load regulation	$I_{O1} = 0.1 \dots 1.0 \times I_{O1 \text{ nom}}$, $I_{O2} = I_{O2 \text{ nom}}$, $V_I = 53 \text{ V}$		30						mV
t_{tr}	Load transient recovery time	$I_O = 0.1 \dots 1.0 \times I_{O \text{ nom}}$, $V_I = 53 \text{ V}$ load step = $0.5 \times I_{O \text{ nom}}$, $I_{O1} = I_{O2}$		100			100			μs
V_{tr}	Load transient voltage			+850			+850			mV
		-850			-850			mV		
T_{coeff}	Temperature coefficient ²⁾	$I_O = I_{O \text{ nom}}$, $T_C < T_{C \text{ max}}$		see PKG 4623 PI Temperature characteristics						
t_r	Ramp-up time	$I_O = 0.1 \dots 1.0 \times I_{O \text{ max}}$ $V_I = 53 \text{ V}$	$0.1 \dots 0.9 \times V_O$	10			10			ms
t_s	Start-up time		From V_I connection to $V_O = 0.9 \times V_{O_i}$	30			30			ms
I_O	Output current			0		4.0	0		4.0	A
$P_{O \text{ max}}$	Max total output power ³⁾	Calculated value		min 60						W
I_{lim}	Current limiting threshold	$T_C < T_{C \text{ max}}$		min $1.02 \times P_{O \text{ max}}$ ⁴⁾						
I_{sc}	Short circuit current	$V_O = 0.2 \dots 0.5 \text{ V}$, $T_A = 25^\circ\text{C}$, $R_{\text{SC}} > 0.1 \Omega$		7			7			A
$V_{O \text{ ac}}$	Output ripple	$I_O = I_{O \text{ nom}}$	20 Hz ... 5 MHz	100	150		100	150		mV _{p-p}
SVR	Supply voltage rejection (ac)	$f = 100 \text{ Hz}$ sine wave, $1 V_{p-p}$, $V_I = 53 \text{ V}$ (SVR = $20 \log(1 V_{p-p}/V_{O \text{ p-p}})$)		43			43			dB
OVP	Over voltage protection	$I_O > 0.1 \times I_{O \text{ max}}$		14.5						V

1) See Operating information.

2) Temperature coefficient is positive at low temperatures and negative at high temperatures.

3) See also Typical Characteristics, Power derating.

4) I_{lim} on each output is set by the total load.

Miscellaneous

Characteristics		Conditions	min	typ	max	Unit
η	Efficiency	$I_O = I_{O \text{ nom}}$, $V_I = 53 \text{ V}$		89		%
P_d	Power dissipation	$I_O = I_{O \text{ nom}}$, $V_I = 53 \text{ V}$		7.4		W

PKG 4625 PI

$T_C = -30 \dots +90^\circ\text{C}$, $V_I = 36 \dots 72\text{V}$ unless otherwise specified. $I_{O1 \text{ nom}} = 2.0 \text{ A}$, $I_{O2 \text{ nom}} = 2.0 \text{ A}$.

Output

Characteristics		Conditions		Output 1			Output 2			Unit			
				min	typ	max	min	typ	max				
V_{O_i}	Output voltage initial setting and accuracy	$T_C = +25^\circ\text{C}$, $I_O = I_{O \text{ nom}}$, $V_I = 53 \text{ V}$		14.90	15.00	15.10	14.90	15.00	15.10	V			
	Output adjust range ¹⁾			12.00		16.50		12.00		16.50		V	
V_O	Output voltage tolerance band	Long term drift included	$I_O = 0.1 \dots 1.0 \times I_{O \text{ nom}}$ $I_{O1} = I_{O2}$		14.20		15.65		14.20		15.65		V
	Idling voltage	$I_O = 0 \text{ A}$		17			26			V			
	Line regulation	$I_O = I_{O \text{ nom}}$	$V_I = 36 \dots 60 \text{ V}$		15			15			mV		
			$V_I = 50 \dots 72 \text{ V}$		15			15					
	Load regulation	$I_{O1} = 0.1 \dots 1.0 \times I_{O1 \text{ nom}}$, $I_{O2} = I_{O2 \text{ nom}}$, $V_I = 53 \text{ V}$		50			50			mV			
t_{tr}	Load transient recovery time	$I_O = 0.1 \dots 1.0 \times I_{O \text{ nom}}$, $V_I = 53 \text{ V}$ load step = $0.5 \times I_{O \text{ nom}}$, $I_{O1} = I_{O2}$		150			150			μs			
V_{tr}	Load transient voltage			+600			+600			mV			
				-600			-600			mV			
T_{coeff}	Temperature coefficient ²⁾	$I_O = I_{O \text{ nom}}$, $T_C < T_{C \text{ max}}$		see PKG 4625 PI Temperature characteristics									
t_r	Ramp-up time	$I_O = 0.1 \dots 1.0 \times I_{O \text{ max}}$ $V_I = 53 \text{ V}$	$0.1 \dots 0.9 \times V_O$		5			5			ms		
t_s	Start-up time		From V_I connection to $V_O = 0.9 \times V_{O_i}$		15			15			ms		
I_O	Output current			0		3.2		0		3.2		A	
$P_{O \text{ max}}$	Max total output power ³⁾	Calculated value		min 60						W			
I_{lim}	Current limiting threshold	$T_C < T_{C \text{ max}}$		min $1.02 \times P_{O \text{ max}}$ ⁴⁾									
I_{sc}	Short circuit current	$V_O = 0.2 \dots 0.5 \text{ V}$, $T_A = 25^\circ\text{C}$, $R_{\text{SC}} > 0.1 \Omega$		9			9			A			
$V_{O \text{ ac}}$	Output ripple	$I_O = I_{O \text{ nom}}$	20 Hz ... 5 MHz		60		150		60		150		mV _{p-p}
SVR	Supply voltage rejection (ac)	$f = 100 \text{ Hz}$ sine wave, $1 V_{p-p}$, $V_I = 53 \text{ V}$ (SVR = $20 \log(1 V_{p-p}/V_{O \text{ p-p}})$)		45			45			dB			
OVP	Over voltage protection	$I_O > 0.1 \times I_{O \text{ max}}$		18.5						V			

1) See Operating information.

2) Temperature coefficient is positive at low temperatures and negative at high temperatures.

3) See also Typical Characteristics, Power derating.

4) I_{lim} on each output is set by the total load.

Miscellaneous

Characteristics		Conditions		min	typ	max	Unit
η	Efficiency	$I_O = I_{O \text{ nom}}$, $V_I = 53 \text{ V}$		88			%
P_d	Power dissipation	$I_O = I_{O \text{ nom}}$, $V_I = 53 \text{ V}$		8.2			W

PKG 4627 PI

$T_C = -30...+90^{\circ}\text{C}$, $V_I = 36 \dots 72\text{V}$ unless otherwise specified. $I_{O1 \text{ nom}} = 6.0 \text{ A}$, $I_{O2 \text{ nom}} = 2.5 \text{ A}$.

Output

Characteristics		Conditions		Output 1			Output 2			Unit
				min	typ	max	min	typ	max	
V_{O_i}	Output voltage initial setting and accuracy	$T_C = +25^{\circ}\text{C}$, $I_O = I_{O \text{ nom}}$, $V_I = 53 \text{ V}$		5.11	5.15	5.19	11.92	12.10	12.28	V
	Output adjust range ¹⁾			4.63	5.67		10.80	13.20		V
V_O	Output voltage tolerance band	Long term drift included	$I_O = 0.1 \dots 1.0 \times I_{O \text{ nom}}$ $I_{O1} = 2.4 \times I_{O2}$	5.00	5.25		11.70	12.60		V
	Idling voltage	$I_O = 0 \text{ A}$		5.9			20		V	
	Line regulation	$I_O = I_{O \text{ nom}}$	$V_I = 36 \dots 60 \text{ V}$	12			25			mV
			$V_I = 50 \dots 72 \text{ V}$	4			8			
	Load regulation	$I_{O1} = 0.1 \dots 1.0 \times I_{O1 \text{ nom}}$, $I_{O2} = I_{O2 \text{ nom}}$, $V_I = 53 \text{ V}$		10						mV
t_{tr}	Load transient recovery time	$I_O = 0.1 \dots 1.0 \times I_{O \text{ nom}}$, $V_I = 53 \text{ V}$ load step = $0.5 \times I_{O \text{ nom}}$		100			100			μs
V_{tr}	Load transient voltage			+350			+850			mV
		-400			-850			mV		
T_{coeff}	Temperature coefficient ²⁾	$I_O = I_{O \text{ nom}}$, $T_C < T_{C \text{ max}}$		see PKG 4627 PI Temperature characteristics						
t_r	Ramp-up time	$I_O = 0.1 \dots 1.0 \times I_{O \text{ max}}$ $V_I = 53 \text{ V}$	$0.1 \dots 0.9 \times V_O$	10			10			ms
t_s	Start-up time		From V_I connection to $V_O = 0.9 \times V_{O_i}$	30			30			ms
I_O	Output current			0	9.0		0	3.0		A
$P_{O \text{ max}}$	Max total output power ³⁾	Calculated value		min 60						W
I_{lim}	Current limiting threshold	$T_C < T_{C \text{ max}}$		min $1.02 \times P_{O \text{ max}}^4)$						
I_{sc}	Short circuit current	$V_O = 0.2 \dots 0.5 \text{ V}$, $T_A = 25^{\circ}\text{C}$, $R_{\text{SC}} > 0.1 \Omega$		17			7			A
$V_{O \text{ ac}}$	Output ripple	$I_O = I_{O \text{ nom}}$	20 Hz ... 5 MHz	100	150		100	150		mV _{p-p}
SVR	Supply voltage rejection (ac)	$f = 100 \text{ Hz}$ sine wave, $1 V_{p-p}$, $V_I = 53 \text{ V}$ (SVR = $20 \log(1 V_{p-p}/V_{O \text{ p-p}})$)		43			43			dB
OVP	Over voltage protection	$I_O > 0.1 \times I_{O \text{ max}}$		6						V

1) See Operating information.

2) Temperature coefficient is positive at low temperatures and negative at high temperatures.

3) See also Typical Characteristics, Power derating.

4) I_{lim} on each output is set by the total load.

Miscellaneous

Characteristics		Conditions		min	typ	max	Unit
η	Efficiency	$I_O = I_{O \text{ nom}}$, $V_I = 53 \text{ V}$			88		%
P_d	Power dissipation	$I_O = I_{O \text{ nom}}$, $V_I = 53 \text{ V}$			8.2		W

Typical Characteristics

PKG 4319 PI

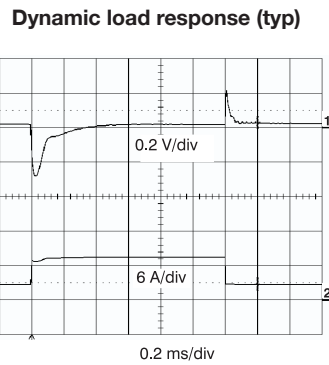
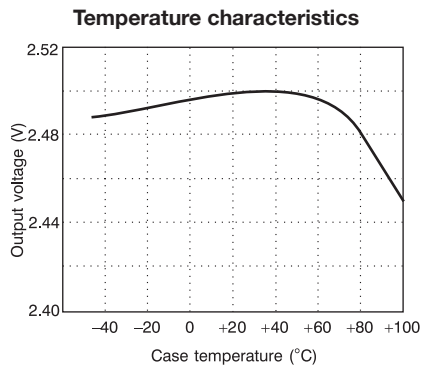
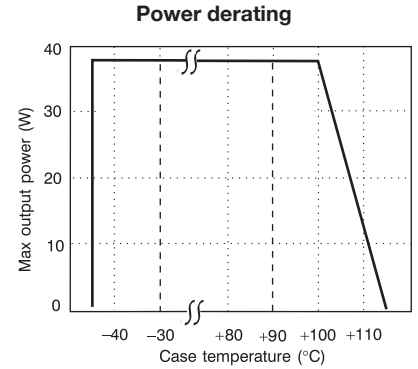
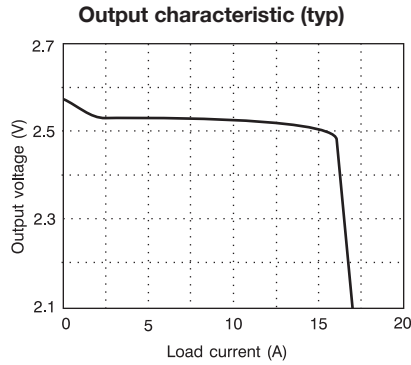
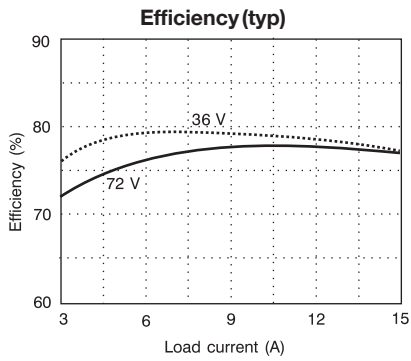

1. Maximum deviation $\Delta V_O < 0.1 \times V_{O_i}$
 Recover time $t_r < 100 \mu s$
 The output voltage deviation is determined by the load transient (di/dt)

2. Load change:
 $0.25 \times I_{O_{nom}} \dots 0.75 \times I_{O_{nom}} \dots 0.25 \times I_{O_{nom}}$
 $di/dt \approx 5A/\mu s$

PKG 4410 PI

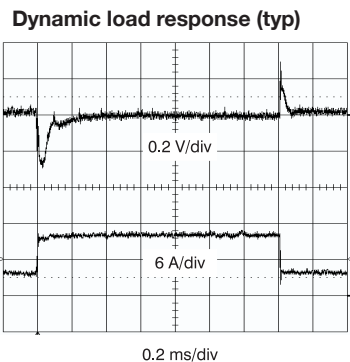
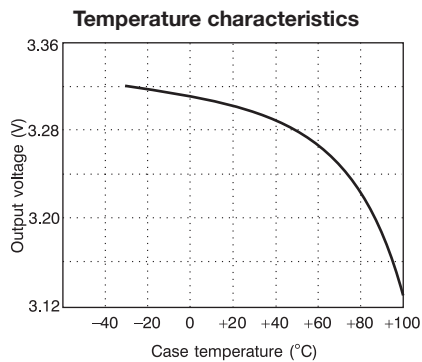
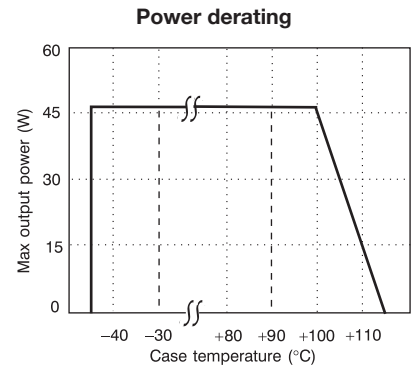
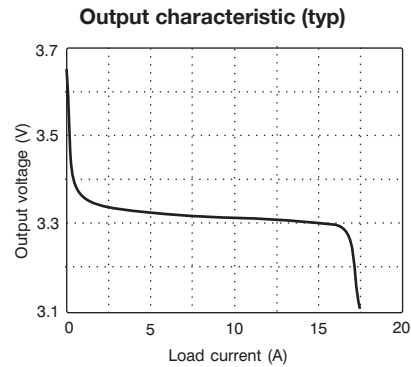
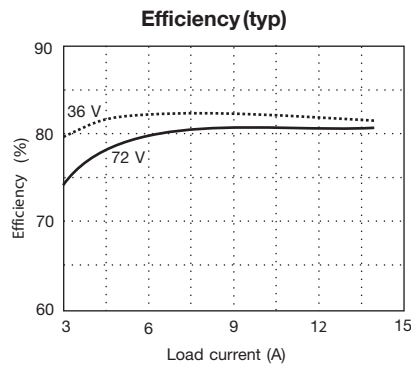

1. Maximum deviation $\Delta V_O < 0.1 \times V_{O_i}$
 Recover time $t_r < 100 \mu s$
 The output voltage deviation is determined by the load transient (di/dt)

2. Load change:
 $0.25 \times I_{O_{nom}} \dots 0.75 \times I_{O_{nom}} \dots 0.25 \times I_{O_{nom}}$
 $di/dt \approx 5A/\mu s$

PKG 4611 PI

Efficiency (typ)

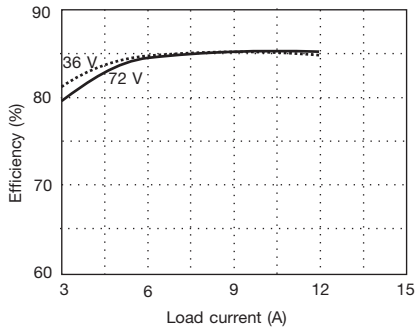

Output characteristic (typ)

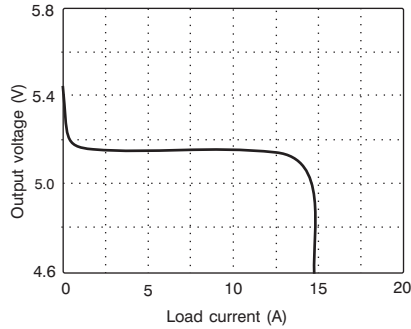

Power derating

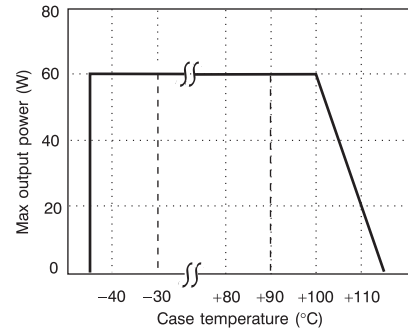

Temperature characteristics

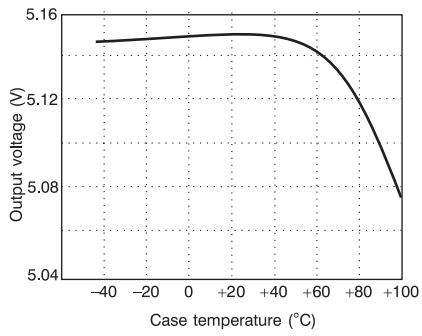

Dynamic load response (typ)

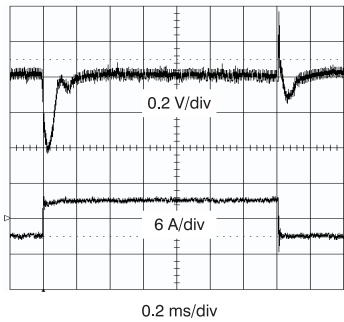

1. Maximum deviation $\Delta V_O < 0.1 \times V_{O1}$
Recover time $t_r < 100 \mu s$
The output voltage deviation is determined by the load transient (di/dt)
2. Load change:
 $0.25 \times I_{O\text{nom}} \dots 0.75 \times I_{O\text{nom}} \dots 0.25 \times I_{O\text{nom}}$
 $di/dt \approx 5A/\mu s$

PKG 4617 PIOA

Efficiency (typ)

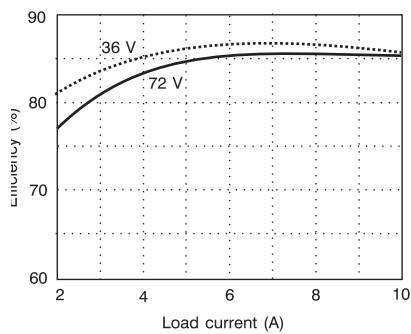

Output characteristic (typ)

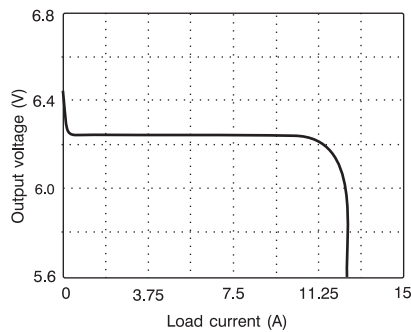

Power derating

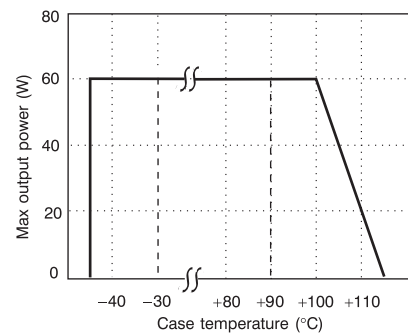

Temperature characteristics

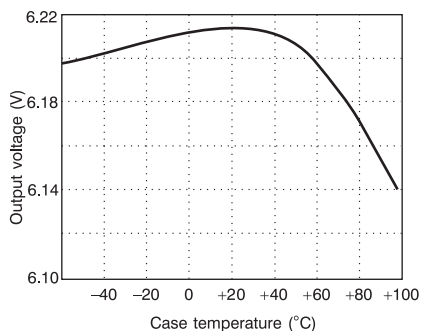

Dynamic load response (typ)

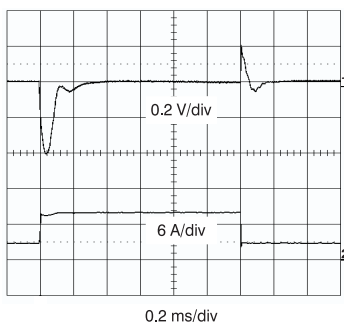

1. Maximum deviation $\Delta V_O < 0.1 \times V_{O1}$
Recover time $t_r < 100 \mu s$
The output voltage deviation is determined by the load transient (di/dt)
2. Load change:
 $0.25 \times I_{O\text{nom}} \dots 0.75 \times I_{O\text{nom}} \dots 0.25 \times I_{O\text{nom}}$
 $di/dt \approx 5A/\mu s$

PKG 4428 PI

Efficiency (typ)

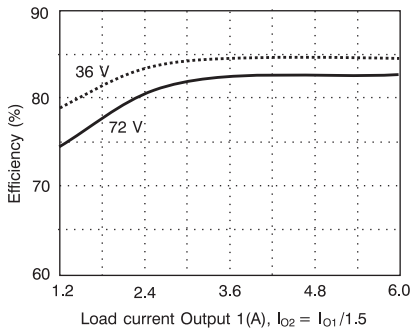

Output characteristic (typ)

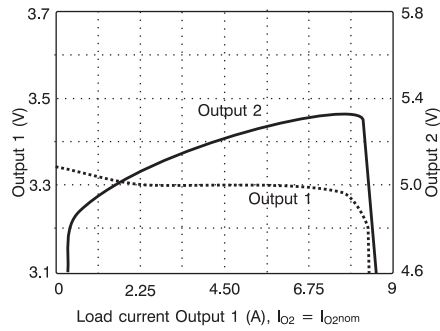

Power derating

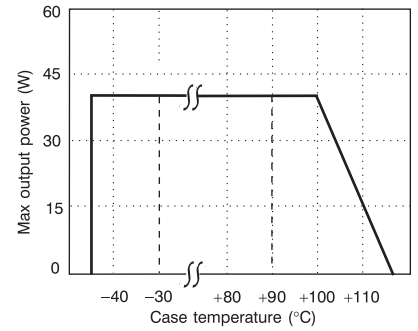

Temperature characteristics

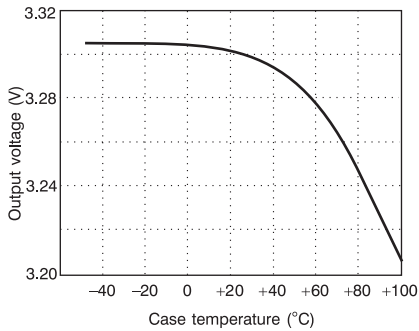

Dynamic load response (typ)

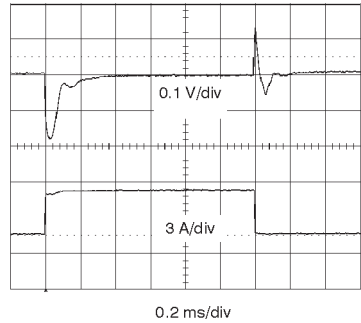

1. Maximum deviation $\Delta V_O < 0.1 \times V_{O1}$
Recover time $t_r < 100 \mu s$
The output voltage deviation is determined by the load transient (dI/dt)

2. Load change:
 $0.25 \times I_{O nom} \dots 0.75 \times I_{O nom} \dots 0.25 \times I_{O nom}$
 $dI/dt \approx 5 A/\mu s$

PKG 4623 PI

Efficiency (typ)

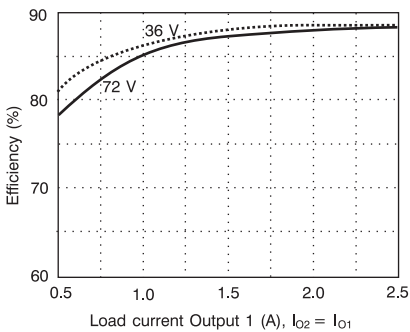

Output characteristic (typ)

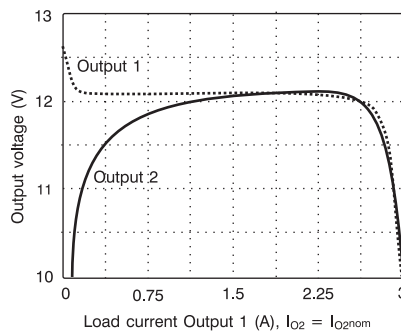

Power derating

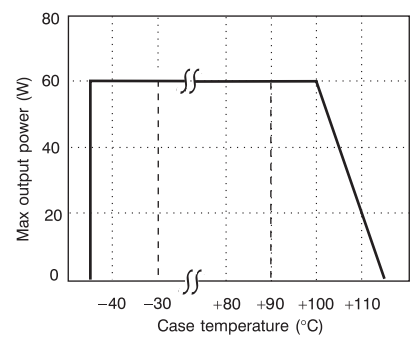

Temperature characteristics

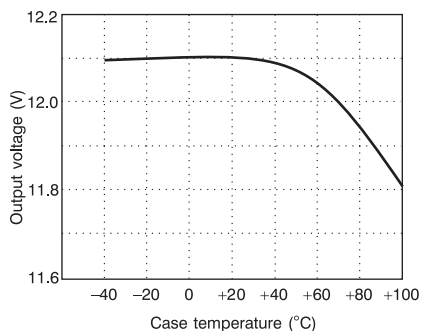

Dynamic load response (typ)¹⁾

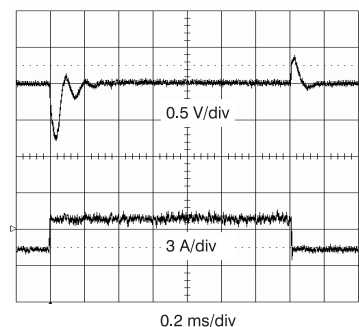

1. Maximum deviation $\Delta V_O < 0.1 \times V_{O1}$
Recover time $t_r < 100 \mu s$
The output voltage deviation is determined by the load transient (dI/dt)

2. Load change:
 $0.25 \times I_{O nom} \dots 0.75 \times I_{O nom} \dots 0.25 \times I_{O nom}$
 $dI/dt \approx 5 A/\mu s$

1) Outputs paralleled.

PKG 4625 PI

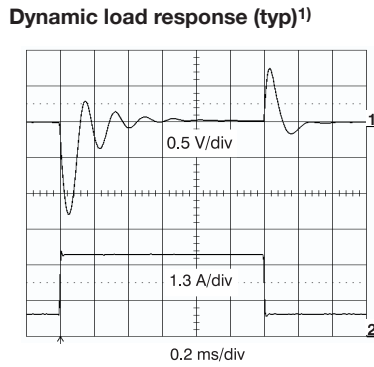
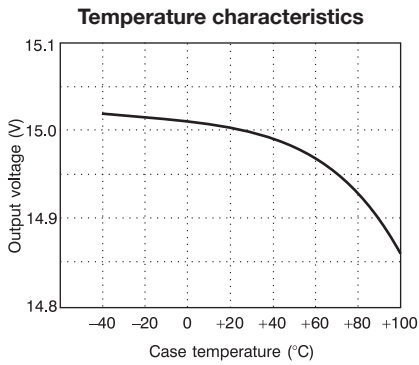
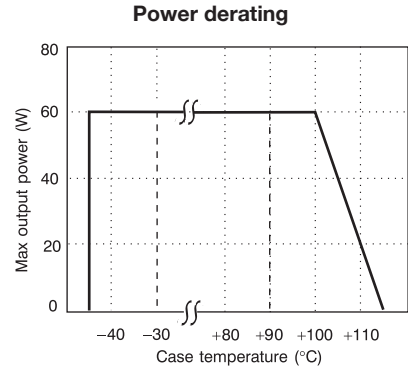
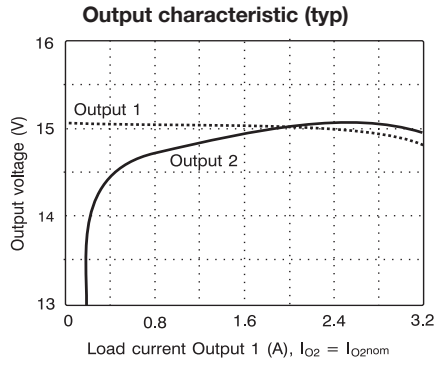
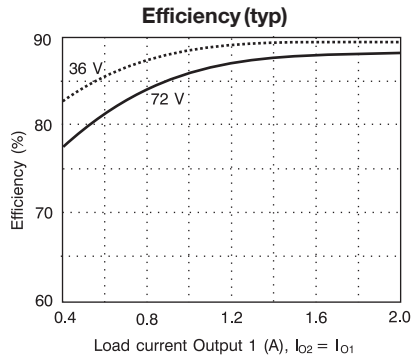

1. Maximum deviation $\Delta V_O < 0.1 \times V_{O_i}$
The output voltage deviation is determined by the load transient (di/dt)

2. Load change:
 $0.25 \times I_{O2nom} \dots 0.75 \times I_{O2nom} \dots 0.25 \times I_{O2nom}$
 $di/dt \approx 5A/\mu s$

¹⁾ Outputs paralleled.

PKG 4627 PI

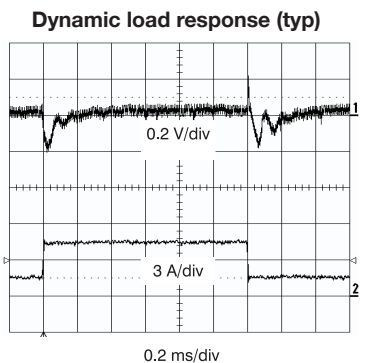
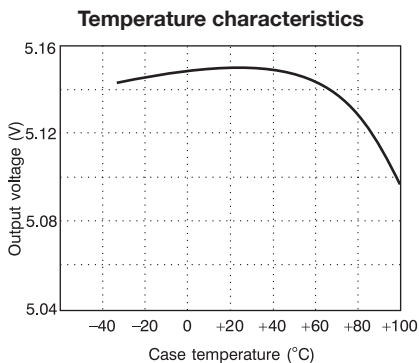
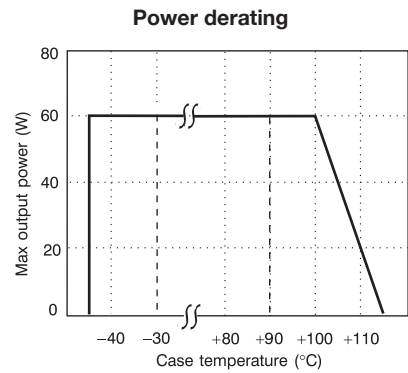
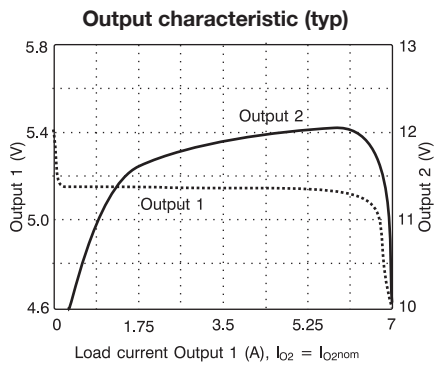
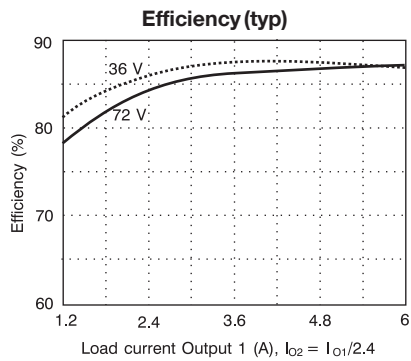

1. Maximum deviation $\Delta V_O < 0.1 \times V_{O_i}$
Recover time $t_r < 100 \mu s$
The output voltage deviation is determined by the load transient (di/dt)

2. Load change:
 $0.25 \times I_{O2nom} \dots 0.75 \times I_{O2nom} \dots 0.25 \times I_{O2nom}$
 $di/dt \approx 5A/\mu s$

EMC Specifications

The PKG DC/DC converter is mounted on a double sided printed circuit board (PB) with groundplane during EMC measurements. The fundamental switching frequency is 510 kHz $\pm 5\%$ @ $V_I = 53V$, $I_O = (0.1...1.0) \times I_{O\ max}$.

Conducted EMI Input terminal value (typ)

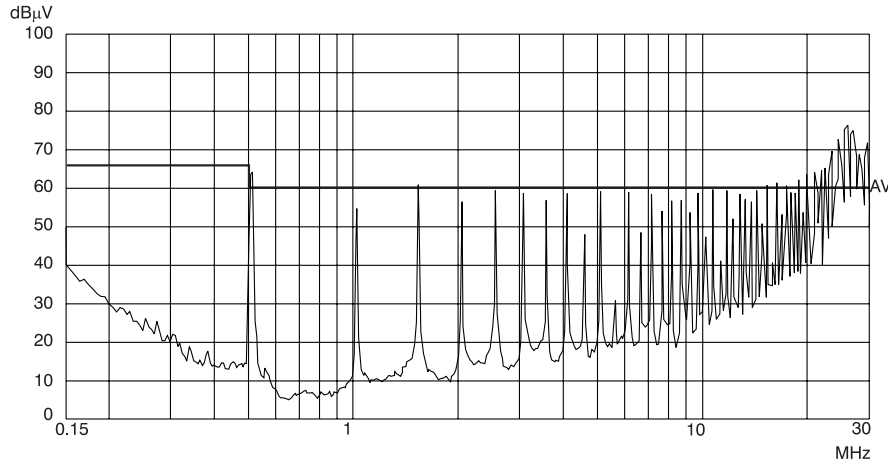

External Filter (class B)

Required external input filter in order to meet class B in EN 55022, CISPR 22 and FCC part 15J.

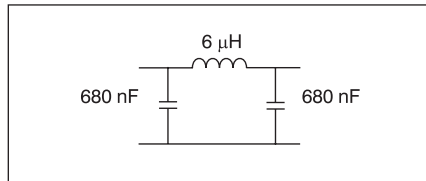

The capacitors are of ceramic type. The low ESR is critical for the result.

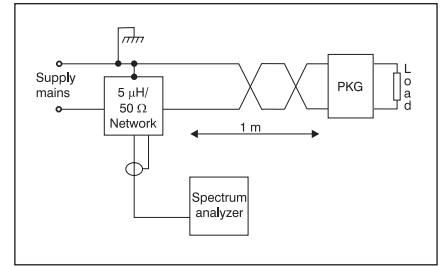
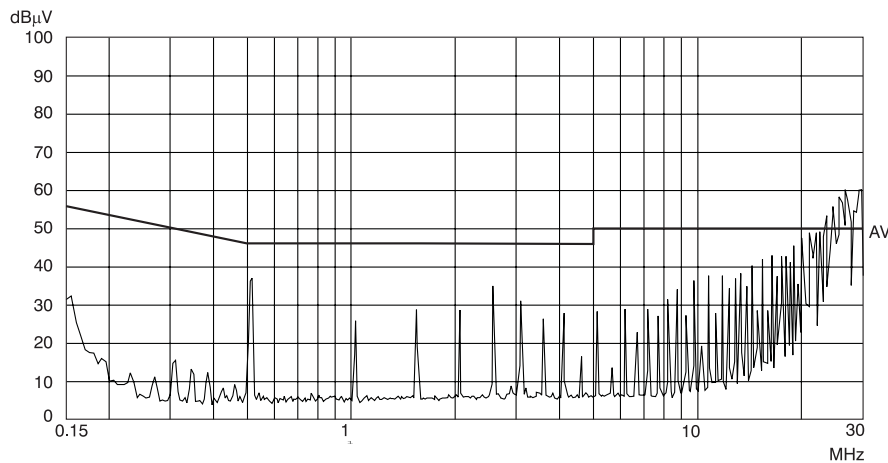

Test Set-up according to CISPR publ. 1A.

Radiated EMS (Electro-Magnetic Fields)

Radiated EMS is measured according to test methods in IEC Standard publ. 801-3. No deviation outside the V_O tolerance band will occur under the following conditions:

Frequency range	Voltage level
0.01...200 MHz	3 V_{rms}/m
200...1,000 MHz	3 V_{rms}/m
1...12 GHz	10 V_{rms}/m

EFT

Electrical Fast Transients on the input terminals may cause output deviations outside what is tolerated by the electronic circuits, i.e. $\pm 5\%$.

The PKG power module can withstand EFT levels of 0.5 kV keeping V_O within the tolerance band and 2.0 kV without destruction. Tested according to IEC publ. 801-4.

Output Ripple & Noise (V_{Oac})

Output ripple is measured as the peak to peak voltage of the fundamental switching frequency.

Operating information

Remote Control (RC)

Remote turn-on and turn-off can be realized by using the RC-pin. Normal operation is achieved if pin 1 is open (NC). If pin 1 is connected to pin 4 the PKG DC/DC converter turns off. To ensure safe turn-off the voltage difference between pin 1 and 4 shall be less than 0.6 V. RC is TTL open collector compatible (see fig. 1).

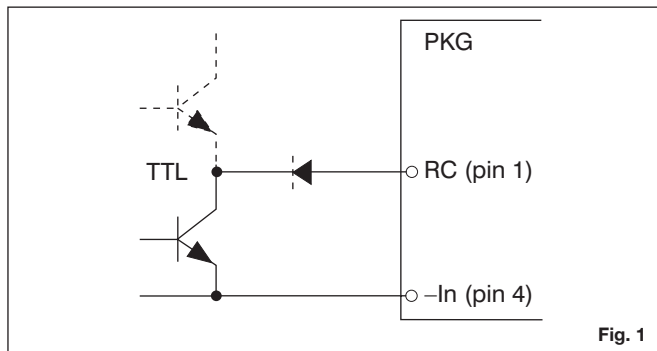

Fig. 1

Over Voltage Protection (OVP)

The PKG 4000 I DC/DC converter series has an internal Over Voltage Protection circuitry (latching). The circuitry will detect over voltage conditions on the output and stop the converter operation. The recommended way to reset the OVP is by removing the input voltage. The OVP can not be triggered from the output (it can not be tested by applying high voltage on the output pins) and occurs only if the DC/DC converter has a real failure.

Output Voltage Adjust (V_{adj})

To decrease the output voltage the resistor should be connected between pin 10 and pin 9 (+Out 1). To increase the output voltage the resistor should be connected between pin 10 and pin 8 (-Out1). Output voltage, V_O , can be adjusted by using an external resistor. A 0.1 M Ω resistor will change V_O approximately 5%. For more information see AN 104 G.

Maximum Capacitive Load

The PKG DC/DC converter series has no limitation of maximum connected capacitance on the output, however the converter may operate in current limiting mode during start-up, affecting the ramp-up and the start-up time if large capacitance values are connected. For optimum performance we recommend a maximum of 100 $\mu\text{F}/\text{A}$ of I_O for dual outputs. Connect capacitors at the point of load for best performance.

Parallel Operation

The load regulation characteristics and temperature coefficients of the PKG DC/DC converter are designed to allow parallel operation. Paralleling of several modules is easily accomplished by connection of the output voltage terminal pins. The connections should be symmetrical, i.e. the resistance between the output terminal and the common connection point of each module should be equal. Good paralleling performance is achieved if you allow the resistance to be 10 m Ω . 10 m Ω equals 50 mm (2 in) of 35 μm (1 oz/ft²) copper with a trace width of 2.5 mm (0.1 in). It is recommended not to exceed $P_O = n \times 0.8 \times P_{Omax}$, where P_{Omax} is the maximum converter output power and n the number of paralleled converters, in order to avoid overloading any of the converters and thereby decreasing the reliability. Paralleling performance may be further improved by voltage matching. Voltage matching is accomplished by using the Output Adjust function and trim the outputs to the same voltage.

Current Limiting Protection

The output power is limited at loads above the output current limiting threshold (I_{lim}), specified as a minimum value.

Input and Output Impedance

Both the source impedance of the power feeding and the load impedance will interact with the impedance of the DC/DC converter. It is most important to have the ratio between L and C as low as possible, i.e. a low characteristic impedance, both at the input and output, as the converters have a low energy storage capability. Use an electrolytic capacitor across the input or output if the source or load inductance is larger than 10 μH . Their equivalent series resistance together with the capacitance acts as a lossless damping filter. Suitable capacitor values are in the range 10–100 μF .

Delivery Package Information

PKG 4000I series standard delivery package is a 50 pcs box (One box contains 5 full trays).

Tray Specification

Material:	Polystyrene (PS)
Max surface resistance:	10 M Ω /sq
Color:	Black
Capacity:	10 pcs/tray
Loaded tray stacking pitch:	17 mm
Weight:	133 g

Quality

Reliability

Meantime between failure (MTBF) is calculated to >1.7 million hours at full output power and a case temperature of +75°C ($T_A = +40^\circ\text{C}$), using the Ericsson failure rate data system. The Ericsson failure rate data system is based on field failure rates and is continuously updated. The data corresponds to actual failure rates of component used in Information Technology and Telecom equipment in temperature controlled environments ($T_A = -5\dots+65^\circ\text{C}$). The data is considered to have a confidence level of 90%. For more information see Design Note 002.

Compatibility with RoHS requirements

The products are compatible with the relevant clauses and requirements of the RoHS directive 2002/95/EC and have a maximum concentration value of 0.1% by weight in homogeneous materials for lead, mercury, hexavalent chromium, PBB and PBDE and of 0.01% by weight in homogeneous materials for cadmium.

Exemptions in the RoHS directive utilized in Ericsson Power Modules products include:

- Lead in high melting temperature type solder (used to solder the die in semiconductor packages)
- Lead in glass of electronics components and in electronic ceramic parts (e.g. fill material in chip resistors)
- Lead as an alloying element in copper alloy containing up to 4% lead by weight (used in connection pins made of Brass)

Quality Statement

The products are designed and manufactured in an industrial environment where quality systems and methods like ISO 9000, 6σ and SPC, are intensively in use to boost the continuous improvements strategy. Infant mortality or early failures in the products are screened out by a burn-in procedure and an ATE-based final test. Conservative design rules, design reviews and product qualifications, as well as high competence of an engaged work force, contribute to the high quality of our products.

Warranty

Warranty period and conditions are defined in Ericsson Power Modules General Terms and Conditions of Sale.

Limitation of Liability

Ericsson Power Modules does not make any other warranties, expressed or implied including any warranty of merchantability or fitness for a particular purpose (including, but not limited to, use in life support applications, where malfunctions of product can cause injury to a person's health or life).

Product Program

V _i	V _o /I _o max		P _o max	Ordering No.
	Output 1	Output 2		
48/60 V	2.5 V/15 A		38 W	PKG 4319 PI
	3.3 V/14 A		46 W	PKG 4410 PI
	5 V/12 A		60 W	PKG 4611 PI
	6.2 V/10 A		60 W	PKG 4617 PIOA
	3.3 V/9.6 A	5 V/6.4 A	40 W	PKG 4428 PI
	12 V/4 A	12 V/4 A	60 W	PKG 4623 PI
	15 V/3.2 A	15 V/3.2 A	60 W	PKG 4625 PI
	5 V/9 A	12 V/3 A	60 W	PKG 4627 PI

Information given in this data sheet is believed to be accurate and reliable.
 No responsibility is assumed for the consequences of its use nor for any infringement of patents or other rights of third parties which may result from its use.
 No license is granted by implication or otherwise under any patent or patent rights of Ericsson Power Modules. These products are sold only according to Ericsson Power Modules' general conditions of sale, unless otherwise confirmed in writing. Specifications subject to change without notice.

Ericsson Power Modules

SE-126 25 Stockholm, Sweden
 Telephone: +46 8 568 69620

For local sales contacts, please refer to our website
www.ericsson.com/powermodules
 or call: Int +46 8 568 69620, Fax: +46 8 568 69599

Americas

Ericsson Inc., Power Modules
 +1-972 583 5254, +1-972 583
 6910

Americas

Asia/Pacific Ericsson Ltd.

The latest and most complete information can be found on our website!

Datasheet

EN/LZT 146 04 R3A
 © Ericsson Power Modules AB, April 2007