

RS5/RD5-R10/RD10

- 8 Pin SIL/ 16Pin DIL Package
- Wide 2:1 Input Range
- 1000VDC Isolation
- Up to 3000VDC Isolation
- Continuous Short Circuit Protection
- Efficiency up to 77%
- Operating Temperature Range
-40° ~ +85°C
- Non Conductive Black Plastic Case,
Metal Case (optional)
- Remote on/off Control (optional)

RoHS



OUTPUT SPECIFICATION	ENVIRONMENTAL SPECIFICATION
Voltage accuracy: ±2%	Operating Temperature range: -40°C ~+85°C (see Derating Curve)
Maximum Output Current: See table	Maximum Case Temperature: 100°C
Line regulation: ± 0.5% max.	Storage Temperature : -40°C ~+125°C
LOAD REGULATION: from 25% to 100% Loading: ±1% max.	Cooling : Nature Convection
Cross Regulation (Dual Output): ± 5%	PHYSICAL SPECIFICATIONS:
Short Circuit Protection : Indefinite (Automatic Recovery)	Case Material:Non-conductive Black Plastic (UL94V-0 rated)
Ripple noise (20Mhz bandwidth): 80mV pk-pk max.	Nickel-coated Copper
Temperature coefficient: ±0.02%/°C	PIN Material SIP Case: Alloy42 Solder-coated
Capacitor load: See table	PIN Material DIP Case: Brass Solder-coated Ø 0.5mm
INPUT SPECIFICATIONS	Potting Material: Epoxy (UL94V-0 rated)
Voltage Range: See table	Weight Case-Sip: 4.5g, (6.0g Metal Case)
Max. Input Current: See table	Weight Case-DIP: 6.5g, (8g Metal-Case)
No-Load/Full-Load Input Current: See table	Dimmension SIP: 0.86 x 0.36 x 0.44"
Input Filter: Capacitors	Dimmension DIP: 0.92 x 0.55 x 0.40"
Input Reflected Ripple Current : 35mA pk-pk	ABSOLUTE MAXIMUM RATINGS (1)
GENERAL SPECIFICATIONS	Input Surge Voltage (100ms)/
Efficiency: See table	5 V Models: 12VDC max.
I/O Isolation Voltage (60sec): 1000 ~ 3000VDC	12V Models: 24VDC max.
I/O Isolation Voltage Metal Case: 1000VDC	24V Models: 40VDC max.
I/O Isolation Capacitance: 60pF typ. max.	48V Models: 80VDC max.
I/O Isolation Resistance: 1000M Ohm, min	Soldering Temperature: 260°C max.
Switching Frequency: 100 - 650kHz	EMC SPECIFICATIONS (2)
Humidity: 95% rel H	Radiated-/Conducted Emissions:EN55022 Class A (see EMI Filter note)
Reliability Calculated MTBF : > 1.66Mhrs (MIL-HDBK-217 f)	ESD: IEC 61000-4-2 Perf.Criteria B
Safety Standard: (designed to meet): IEC EN 60950-1	RS: IEC 61000-4-3 Perf.Criteria A
Remote ON/OFF Controll: see note	EFT: IEC 61000-4-4 Perf.Criteria B
	SURGE: IEC 61000-4-5 Perf.Criteria B
	CS: IEC 61000-4-6 Perf.Criteria A
	PFMF IEC 61000-4-8 Perf.Criteria A

1) These are stress ratings. Exposure of devices to any of these conditions may adversely affect long-term reliability.
2) (1.5mm from case 10sec Max.)
3) All specifications typical at TA= 25°C, nominal input voltage and full load unless otherwise specified.
4) The information and specification contained in this data sheet are believed to be correct at time of publication. However RSG accepts no responsibility for consequences arising from printing errors or inaccuracies. Specifications are subject to change without notice.

NUMBER STRUCTURE

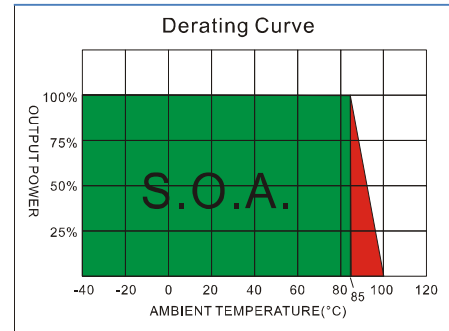
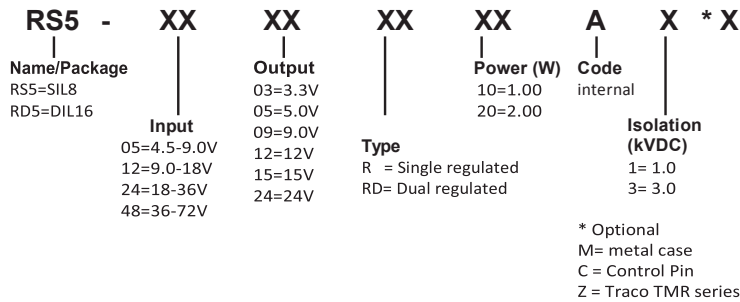

MODEL SELECTION GUIDE

MODEL NUMBER	INPUT Voltage Range (Vdc)	INPUT Current		OUTPUT Voltage (Vdc)	OUTPUT Current		EFFICIENCY @FL (%)	Capacitor Load(uF)
		No-Load	Full Load		Min. load	Full load		
RS5-0503R10AX	4.5-9	15	298	3.3	76	303	67	3300
RS5-0505R10AX	4.5-9	15	298	5	50	200	67	3300
RS5-0509R10AX	4.5-9	40	285	9	28	111	70	470
RS5-0512R10AX	4.5-9	55	285	12	21	83	70	470
RS5-0515R10AX	4.5-9	55	285	15	17	67	70	470
RS5-0524R10AX	4.5-9	70	294	24	10	42	68	220
RS5-1203R10AX	9-18	15	119	3.3	76	303	70	3300
RS5-1205R10AX	9-18	15	115	5	50	200	72	3300
RS5-1209R10AX	9-18	15	108	9	28	111	77	470
RS5-1212R10AX	9-18	15	108	12	21	83	77	470
RS5-1215R10AX	9-18	15	108	15	17	67	77	470
RS5-1224R10AX	9-18	15	114	24	10	42	73	220
RS5-2403R10AX	18-36	8	59	3.3	76	303	70	3300
RS5-2405R10AX	18-36	8	57	5	50	200	72	3300
RS5-2409R10AX	18-36	8	55	9	28	111	75	470
RS5-2412R10AX	18-36	8	55	12	21	83	75	470
RS5-2415R10AX	18-36	8	55	15	17	67	75	470
RS5-2424R10AX	18-36	8	55	24	10	42	75	220
RS5-4803R10AX	36-72	6	31	3.3	76	303	66	3300
RS5-4805R10AX	36-72	6	30	5	50	200	68	3300
RS5-4809R10AX	36-72	6	29	9	28	111	70	470
RS5-4812R10AX	36-72	6	29	12	21	83	70	470
RS5-4815R10AX	36-72	6	29	15	17	67	70	470
RS5-4824R10AX	36-72	6	30	24	10	42	68	220
RD5-0503R10AX	4.5-9	15	298	3.3	76	303	67	3300
RD5-0505R10AX	4.5-9	15	298	5	50	200	67	3300
RD5-0509R10AX	4.5-9	40	285	9	28	111	70	470
RD5-0512R10AX	4.5-9	55	285	12	21	83	70	470
RD5-0515R10AX	4.5-9	55	285	15	17	67	70	470
RD5-0524R10AX	4.5-9	70	294	24	10	42	68	220
RD5-1203R10AX	9-18	15	119	3.3	76	303	70	3300
RD5-1205R10AX	9-18	15	115	5	50	200	72	3300
RD5-1209R10AX	9-18	15	108	9	28	111	77	470
RD5-1212R10AX	9-18	15	108	12	21	83	77	470
RD5-1215R10AX	9-18	15	108	15	17	67	77	470
RD5-1224R10AX	9-18	15	114	24	10	42	73	220

Suffix "3" means 3KVdc isolation Suffix "C" means with control pin Suffix "M" means with Metal Case

RS5/RD5-R10/RD10

MODEL NUMBER	INPUT Voltage Range (Vdc)	INPUT Current		OUTPUT Voltage (Vdc)	OUTPUT Current		EFFICIENCY @FL(%)	Capacitor Load(uF)
		No-Load (mA)	Full Load (mA)		Min. load (mA)	Full load (mA)		
RD5-2403R10AX	18-36	8	59	3.3	76	303	70	3300
RD5-2405R10AX	18-36	8	57	5	50	200	72	3300
RD5-2409R10AX	18-36	8	55	9	28	111	75	470
RD5-2412R10AX	18-36	8	55	12	21	83	75	470
RD5-2415R10AX	18-36	8	55	15	17	67	75	470
RD5-2424R10AX	18-36	8	55	24	10	42	75	220
RD5-4803R10AX	36-72	6	31	3.3	76	303	66	3300
RD5-4805R10AX	36-72	6	30	5	50	200	68	3300
RD5-4809R10AX	36-72	6	29	9	28	111	70	470
RD5-4812R10AX	36-72	6	29	12	21	83	70	470
RD5-4815R10AX	36-72	6	29	15	17	67	70	470
RD5-4824R10AX	36-72	6	30	24	10	42	68	220
RS5-0503RD10AX	4.5-9	15	285	±3.3	±38	±152	70	±1000
RS5-0505RD10AX	4.5-9	15	270	±5	±25	±100	74	±1000
RS5-0509RD10AX	4.5-9	20	270	±9	±14	±56	74	±220
RS5-0512RD10AX	4.5-9	20	266	±12	±10	±42	75	±220
RS5-0515RD10AX	4.5-9	40	285	±15	±8	±33	70	±220
RS5-0524RD10AX	4.5-9	70	298	±24	±5	±21	67	±100
RS5-1203RD10AX	9-18	15	119	±3.3	±38	±152	70	±1000
RS5-1205RD10AX	9-18	15	115	±5	±25	±100	72	±1000
RS5-1209RD10AX	9-18	15	109	±9	±14	±56	76	±220
RS5-1212RD10AX	9-18	15	109	±12	±10	±42	76	±220
RS5-1215RD10AX	9-18	15	112	±15	±8	±33	74	±220
RS5-1224RD10AX	9-18	40	124	±24	±5	±21	67	±100
RS5-2403RD10AX	18-36	8	59	±3.3	±38	±152	70	±1000
RS5-2405RD10AX	18-36	8	59	±5	±25	±100	70	±1000
RS5-2409RD10AX	18-36	8	54	±9	±14	±56	76	±220
RS5-2412RD10AX	18-36	8	54	±12	±10	±42	77	±220
RS5-2415RD10AX	18-36	8	55	±15	±8	±33	75	±220
RS5-2424RD10AX	18-36	20	59	±24	±5	±21	70	±100
RS5-4803RD10AX	36-72	6	30	±3.3	±38	±152	70	±1000
RS5-4805RD10AX	36-72	6	30	±5	±25	±100	70	±1000
RS5-4809RD10AX	36-72	6	28	±9	±14	±56	74	±220
RS5-4812RD10AX	36-72	6	27	±12	±10	±42	76	±220
RS5-4815RD10AX	36-72	6	29	±15	±8	±33	72	±220
RS5-4824RD10AX	36-72	12	30	±24	±5	±21	70	±100
RD5-0503RD10AX	4.5-9	15	285	±3.3	±38	±152	70	±1000
RD5-0505RD10AX	4.5-9	15	270	±5	±25	±100	74	±1000
RD5-0509RD10AX	4.5-9	20	270	±9	±14	±56	74	±220
RD5-0512RD10AX	4.5-9	20	266	±12	±10	±42	75	±220
RD5-0515RD10AX	4.5-9	40	285	±15	±8	±33	70	±220
RD5-0524RD10AX	4.5-9	70	298	±24	±5	±21	67	±100
RD5-1203RD10AX	9-18	15	119	±3.3	±38	±152	70	±1000
RD5-1205RD10AX	9-18	15	115	±5	±25	±100	72	±1000
RD5-1209RD10AX	9-18	15	109	±9	±14	±56	76	±220
RD5-1212RD10AX	9-18	15	109	±12	±10	±42	76	±220
RD5-1215RD10AX	9-18	15	112	±15	±8	±33	74	±220
RD5-1224RD10AX	9-18	40	124	±24	±5	±21	67	±100
RD5-2403RD10AX	18-36	8	59	±3.3	±38	±152	70	±1000
RD5-2405RD10AX	18-36	8	59	±5	±25	±100	70	±1000

Suffix "3" means 3KVdc isolation

Suffix "C" means with control pin

Suffix "M" means with Metal Case

MODEL NUMBER	INPUT Voltage Range	INPUT Current		OUTPUT Voltage (Vdc)	OUTPUT Current		EFFICIENCY @FL(%)	Capacitor Load(μF)
		No-Load (mA)	Full Load (mA)		Min. load (mA)	Full load (mA)		
RD5-2409RD10AX	18-36	8	54	±9	±14	±56	76	±220
RD5-2412RD10AX	18-36	8	54	±12	±10	±42	77	±220
RD5-2415RD10AX	18-36	8	55	±15	±8	±33	75	±220
RD5-2424RD10AX	18-36	20	59	±24	±5	±21	70	±100
RD5-4803RD10AX	36-72	6	30	±3.3	±38	±152	70	±1000
RD5-4805RD10AX	36-72	6	30	±5	±25	±100	70	±1000
RD5-4809RD10AX	36-72	6	28	±9	±14	±56	74	±220
RD5-4812RD10AX	36-72	6	27	±12	±10	±42	76	±220
RD5-4815RD10AX	36-72	6	29	±15	±8	±33	72	±220
RD5-4824RD10AX	36-72	12	30	±24	±5	±21	70	±100

Suffix "3" means 3KVdc isolation

Suffix "C" means with control pin

Suffix "M" means with Metal Case

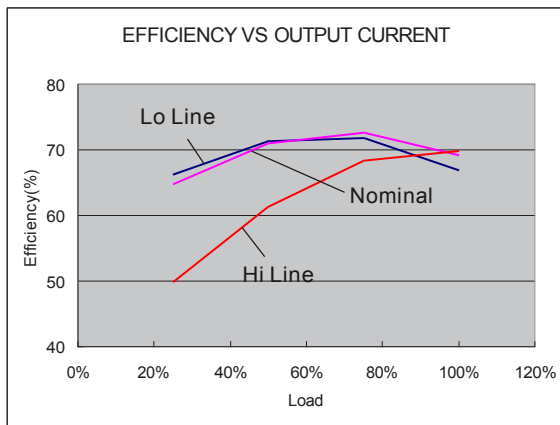

05 Models

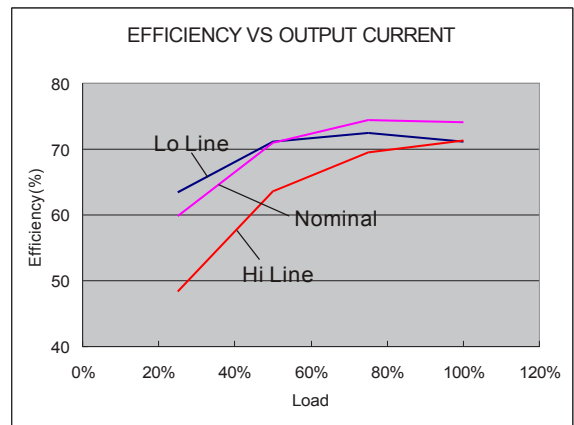

12 Models

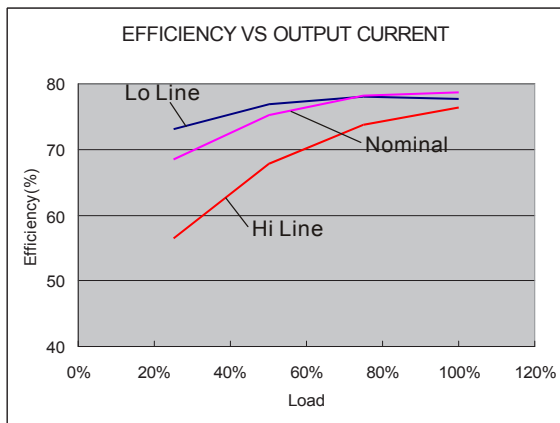

24 Models

1. Maximum value at nominal input voltage and full load.
2. Typical value at nominal input voltage and full load.
3. 25% minimum loading is needed.
4. One load is 25% to 100% load, the other load is 100% load, the output voltage variable rate is within ±5%.
5. Ripple/Noise measured with 20MHz bandwidth.
6. Test by nominal input voltage and constant resistor load.
7. Measured Input reflected ripple current with a simulated source inductance of 12μH.
8. Exceeding the absolute ratings of the unit could cause damage. It is not allowed for continuous operating.
9. Operation under no-load conditions will not damage these devices, however they may not meet all listed specifications.
10. It's necessary to add minimum capacitor in output for some models, please check single model datasheet for detail value.

11. MCU (Master Control Unit)

The MCU Pin Voltage is referenced to -Vin(Pin 1)

ON:0 ~ 0.8VDC Max.

(Short circuit Pin 1 and Pin 3) or open circuit

OFF: 4.5 to 15VDC Max.(or 3.5mA to 15mA Max.)(via R1 \ D1)

OFF idle current: 5mA typ

Connection example



- 12. Input filter components are required to help meet conducted emission class A, which application refer to the EMI Filter of design & test configuration.
- 13. An external filter capacitor is required if the module has to meet IEC61000-4-4 and IEC61000-4-5. The filter capacitor RSG suggest: Nippon - chemi - con KY series, 220uF/100V.

Input Reflected Ripple Current Test Step

Input reflected ripple current is measured through a source inductor Lin(12uH) and a source capacitor Cin(47uF, ESR<1.0@ at 100KHz) at nominal input and full load.

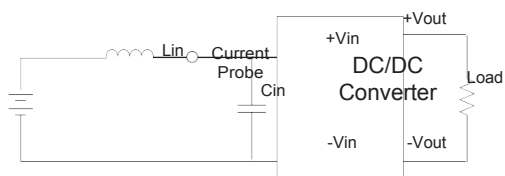

Output Ripple & Noise Measurement Test

The Scope measurement bandwidth is 20MHz.

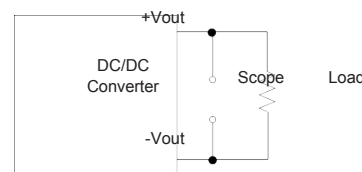

EMI Filter

Input filter components (C1, L) are used to help meet conducted emissions requirement for the module. These components should be mounted as close as possible to the module; and all leads should be minimized to decrease radiated noise.

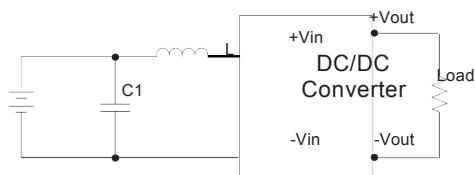

	C1	L
RS5/RD5 -1W	100uF/100V	12uH

The models listed above are just for standard type.
If you need the special specification product, please contact us:
info@rsg-electronic.de

RS5/RD5-R10/RD10

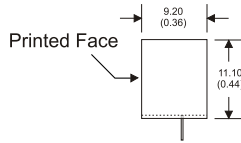
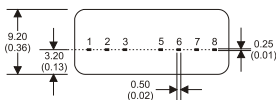
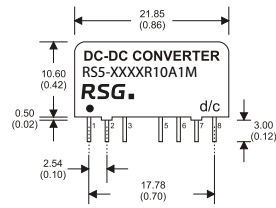
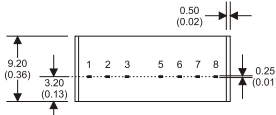
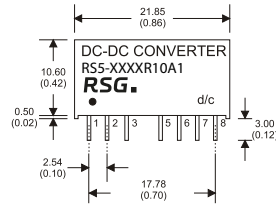

8 Pin SIL Package
Non-Conductive Plastic

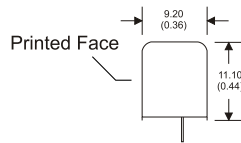

8 Pin SIL Package
Nickel-Coated Copper

Notes: All dimensions are typical in millimeters (inches).
1. Pin diameter: 0.5 ±0.05 (0.02 ±0.002)
2. Pin pitch and length tolerance: ±0.35 (±0.014)
3. Case Tolerance: ±0.5 (±0.02)

PIN CONNECTIONS			
PIN NUMBER	SINGLE	DUAL/(SD)	DUAL/(SZ)
1	-V Input	-V Input	-V Input
2	+V Input	+V Input	+V Input
3	N.P.	N.C.	N.C.
5	N.P.	N.C.	N.C.
6	+V Output	+V Output	+V Output
7	-V Output	-V Output	Common
8	N.C.	Common	-V Output
PIN NUMBER	SINGLE+C	DUAL/(SD+C)	DUAL/(SZ+C)
1	-V Input	-V Input	-V Input
2	+V Input	+V Input	+V Input
3	Remote On/Off	Remote On/Off	Remote On/Off
5	N.C.	N.C.	N.C.
6	+V Output	+V Output	+V Output
7	-V Output	-V Output	Common
8	N.C.	Common	-V Output

(The Pin Connection of high isolation one is the same with normal one.)

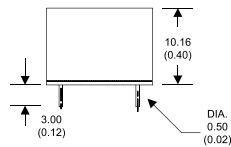
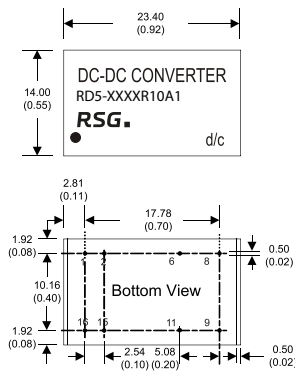

16 Pin DIL Package
Non-Conductive Plastic

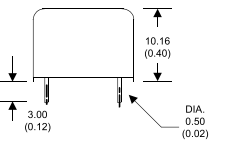
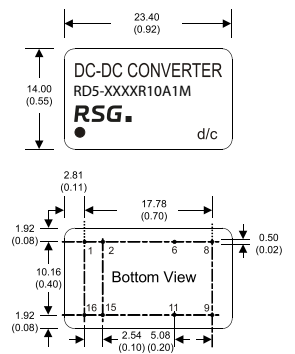

16 Pin DIL Package
Nickel-Coated Copper

PIN CONNECTIONS		
PIN NUMBER	SINGLE	DUAL
1	-V Input	-V Input
2	-V Input	-V Input
6	N.C.	Common
8	N.C.	-V Output
9	+V Output	+V Output
11	-V Output	Common
15	+V Input	+V Input
16	+V Input	+V Input

(The Pin Connection of high isolation one is the same with normal one.)

The models listed here are just standard type. If you need a product with special specification or you have questions regarding packing standards (Tube oder Tape/Reel) as well as application support, please contact our specialists: sales@rsg-electronic.de or +49 69-984047-41/-28