



# N-Channel Depletion-Mode Vertical DMOS FET

## Features

- ▶ High input impedance
- ▶ Low input capacitance
- ▶ Fast switching speeds
- ▶ Low on-resistance
- ▶ Free from secondary breakdown
- ▶ Low input and output leakage

## Applications

- ▶ Normally-on switches
- ▶ Solid state relays
- ▶ Converters
- ▶ Linear amplifiers
- ▶ Constant current sources
- ▶ Power supply circuits
- ▶ Telecom

## General Description

These depletion-mode (normally-on) transistors utilize an advanced vertical DMOS structure and Supertex's well-proven silicon-gate manufacturing process. This combination produces devices with the power handling capabilities of bipolar transistors and with the high input impedance and positive temperature coefficient inherent in MOS devices. Characteristic of all MOS structures, these devices are free from thermal runaway and thermally-induced secondary breakdown.

Supertex's vertical DMOS FETs are ideally suited to a wide range of switching and amplifying applications where high breakdown voltage, high input impedance, low input capacitance, and fast switching speeds are desired.

## Ordering Information

Part Number	Package Options	Packing
SN3545N3-G	TO-92	1000/Bag
SN3545N3-G P002	TO-92	2000/Reel
SN3545N3-G P003	TO-92	2000/Reel
SN3545N3-G P005	TO-92	2000/Reel
SN3545N3-G P013	TO-92	2000/Reel
SN3545N3-G P014	TO-92	2000/Reel
SN3545N8-G	TO-243AA (SOT-89)	2000/Reel

-G denotes a lead (Pb)-free / RoHS compliant package.  
 Contact factory for Wafer / Die availability.  
 Devices in Wafer / Die form are lead (Pb)-free / RoHS compliant.  
 Refer to 'P0xx' Tape & Reel Specs for P002, P003, P005, P013, and P014 TO-92 Taping Specifications and Winding Styles

## Absolute Maximum Ratings

Parameter	Value
Drain-to-source voltage	$BV_{DSX}$
Drain-to-gate voltage	$BV_{DGX}$
Gate-to-source voltage	$\pm 20V$
Operating and storage temperature	$-55^{\circ}C$ to $+150^{\circ}C$

Absolute Maximum Ratings are those values beyond which damage to the device may occur. Functional operation under these conditions is not implied. Continuous operation of the device at the absolute rating level may affect device reliability. All voltages are referenced to device ground.

## Product Summary

$BV_{DSX}/BV_{DGX}$	$R_{DS(ON)}$ (max)	$I_{DSS}$ (min)
450V	20 $\Omega$	200mA

## Pin Configuration

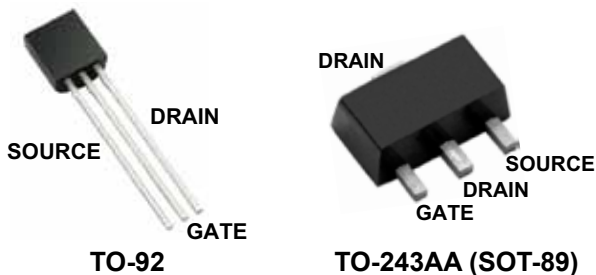

## Product Marking



YY = Year Sealed  
 WW = Week Sealed  
 \_\_\_\_\_ = "Green" Packaging

Package may or may not include the following marks: Si or

**TO-92**



W = Code for week sealed  
 \_\_\_\_\_ = "Green" Packaging

Package may or may not include the following marks: Si or

**TO-243AA (SOT-89)**

## Typical Thermal Resistance

Package	$\theta_{ja}$
TO-92	132 $^{\circ}C/W$
TO-243AA (SOT-89)	133 $^{\circ}C/W$

## Thermal Characteristics

Package	$I_D$ (continuous) <sup>†</sup>	$I_D$ (pulsed)	Power Dissipation @ $T_A = 25^\circ\text{C}$	$I_{DR}$ <sup>†</sup>	$I_{DRM}$
T0-92 (D-PAK)	136mA	1600mA	0.74W	136mA	1600mA
TO-243AA	200mA	300mA	1.6W <sup>‡</sup>	200mA	300mA

**Notes:**

- <sup>†</sup>  $I_D$  (continuous) is limited by max rated  $T_r$ .
- <sup>‡</sup> Mounted on FR4 board, 25mm x 25mm x 1.57mm.

## Electrical Characteristics ( $T_A = 25^\circ\text{C}$ unless otherwise specified)

Sym	Parameter	Min	Typ	Max	Units	Conditions
$BV_{DSX}$	Drain-to-source breakdown voltage	450	-	-	V	$V_{GS} = -5.0\text{V}, I_D = 100\mu\text{A}$
$V_{GS(OFF)}$	Gate-to-source off voltage	-1.5	-	-3.5	V	$V_{DS} = 25\text{V}, I_D = 10\mu\text{A}$
$\Delta V_{GS(OFF)}$	Change in $V_{GS(OFF)}$ with temperature	-	-	-4.5	mV/°C	$V_{DS} = 25\text{V}, I_D = 10\mu\text{A}$
$I_{GSS}$	Gate body leakage current	-	-	100	nA	$V_{GS} = \pm 20\text{V}, V_{DS} = 0\text{V}$
$I_{D(OFF)}$	drain-to-source leakage current	-	-	1.0	$\mu\text{A}$	$V_{GS} = -5.0\text{V}, V_{DS} = \text{Max Rating}$
		-	-	1.0	mA	$V_{GS} = -5.0\text{V}, V_{DS} = 0.8\text{Max Rating}$ $T_A = 125^\circ\text{C}$
$I_{DSS}$	Saturated drain-to-source current	200	-	-	mA	$V_{GS} = 0\text{V}, V_{DS} = 15\text{V}$
$R_{DS(ON)}$	Static drain-to-source on-state resistance	-	-	20	$\Omega$	$V_{GS} = 0\text{V}, I_D = 150\text{mA}$
$\Delta R_{DS(ON)}$	Change in $R_{DS(ON)}$ with temperature	-	-	1.1	%/°C	$V_{GS} = 0\text{V}, I_D = 150\text{mA}$
$G_{FS}$	Forward transductance	150	-	-	mmho	$I_D = 100\text{mA}, V_{DS} = 10\text{V}$
$C_{ISS}$	Input capacitance	-	-	360	pF	$V_{GS} = -5.0\text{V}, V_{DS} = 25\text{V},$ $f = 1.0\text{MHz}$
$C_{OSS}$	Common source output capacitance	-	-	40		
$C_{RSS}$	Reverse transfer capacitance	-	-	15		
$t_{d(ON)}$	Turn-on delay time	-	-	20	ns	$V_{DD} = 25\text{V}, I_D = 150\text{mA},$ $R_{GEN} = 25\Omega, V_{GS} = 0\text{V to } -10\text{V}$
$t_r$	Rise time	-	-	30		
$t_{d(OFF)}$	Turn-off delay time	-	-	30		
$t_f$	Fall time	-	-	40		
$V_{SD}$	Diode forward voltage drop	-	-	1.8	V	$V_{GS} = -5.0\text{V}, I_{SD} = 150\text{mA}$
$t_{rr}$	Reverse recovery time	-	800	-	ns	$V_{GS} = -5.0\text{V}, I_{SD} = 150\text{mA}$

**Notes:**

- All D.C. parameters 100% tested at 25°C unless otherwise stated. (Pulse test: 300µs pulse, 2% duty cycle.)
- All A.C. parameters sample tested.

## Switching Waveforms and Test Circuit

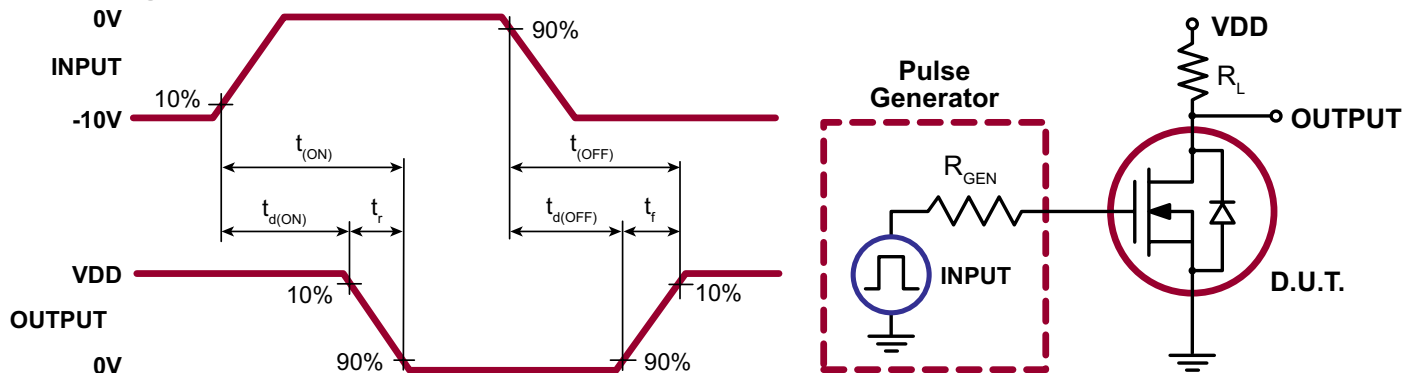

# Typical Performance Curves

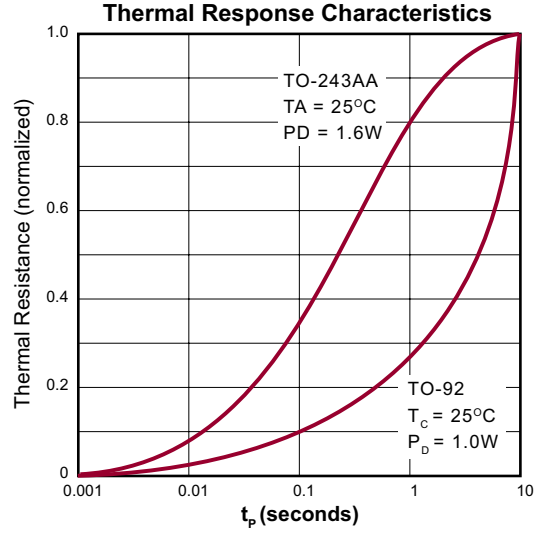
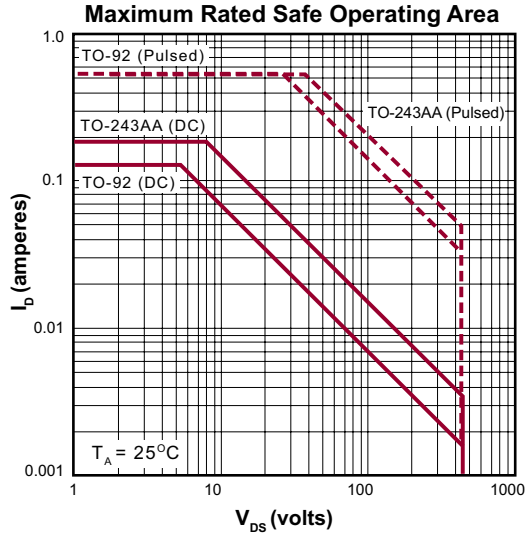
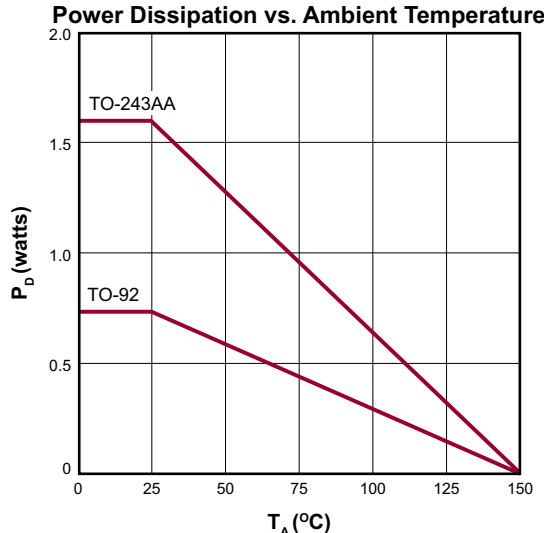
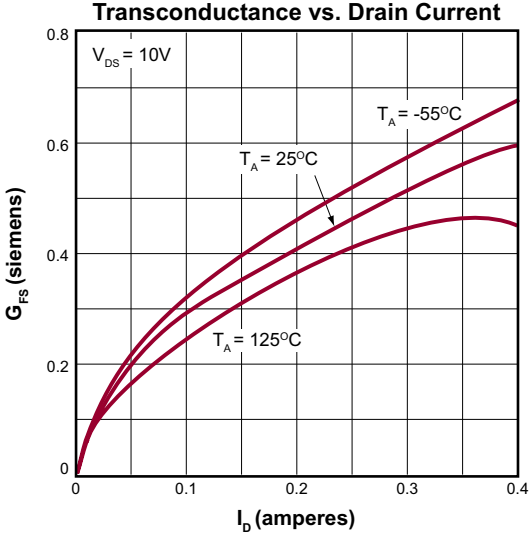
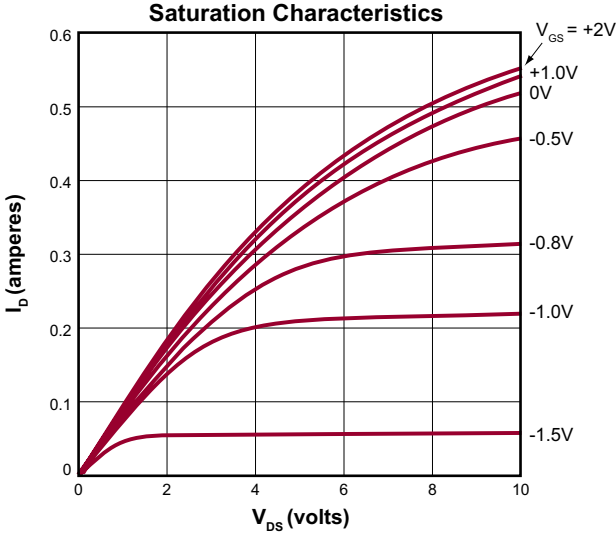
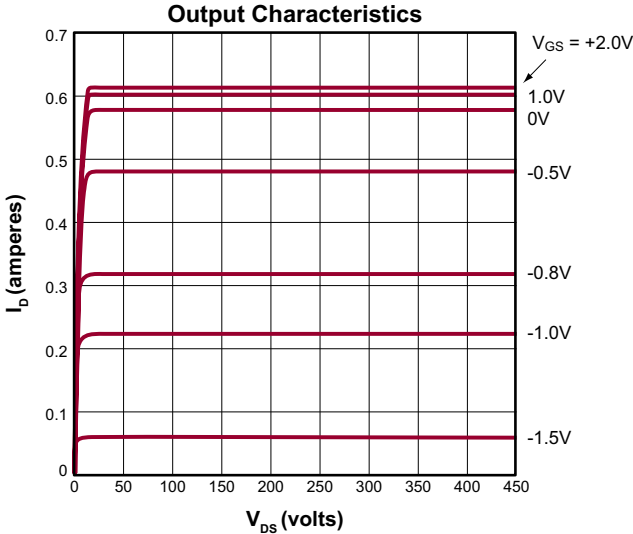

Typical Performance Curves (cont.)

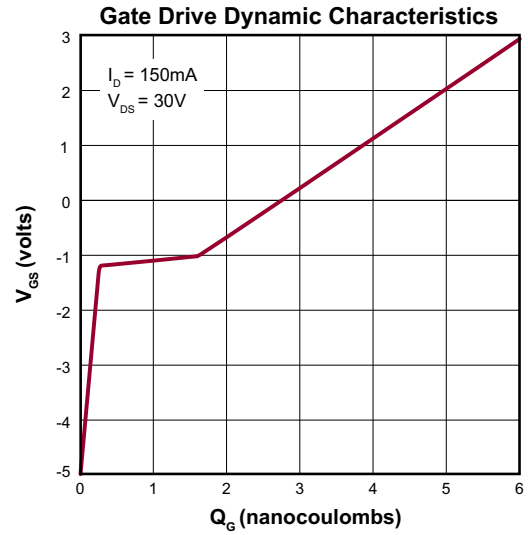
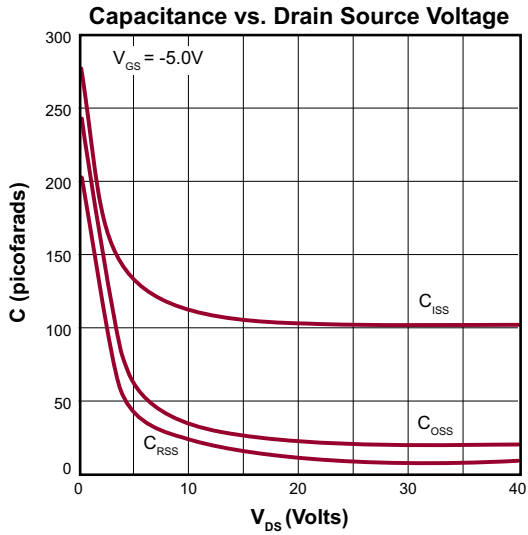
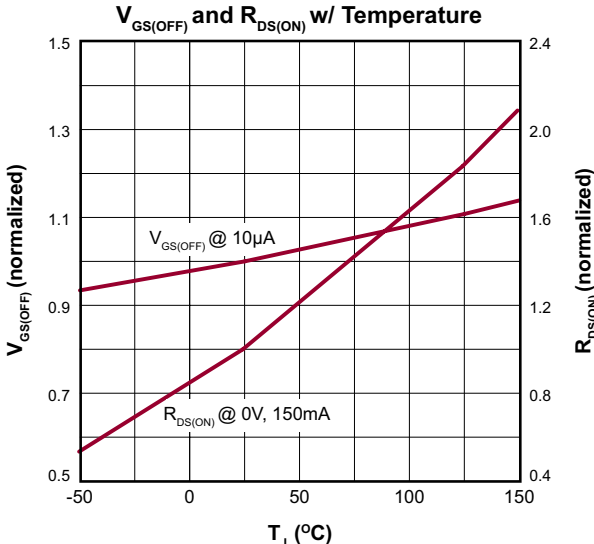
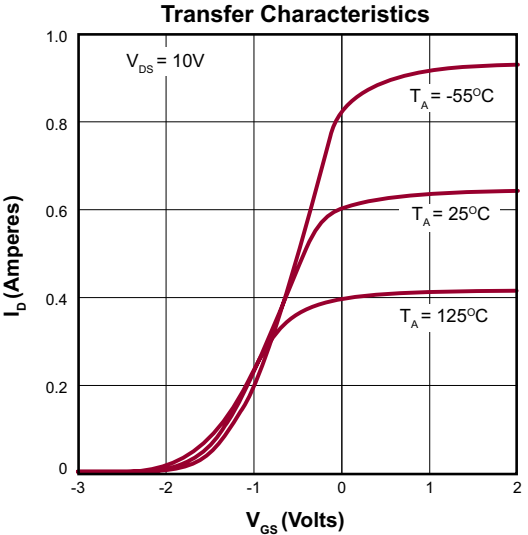
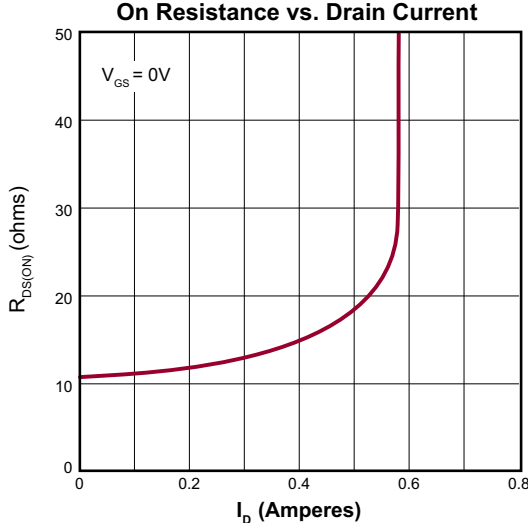
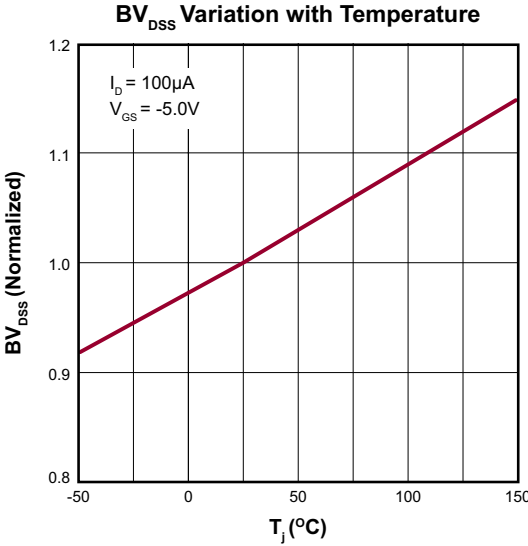

### 3-Lead TO-92 Package Outline (N3)

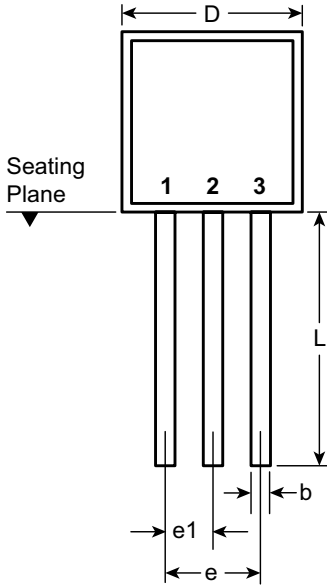

**Front View**

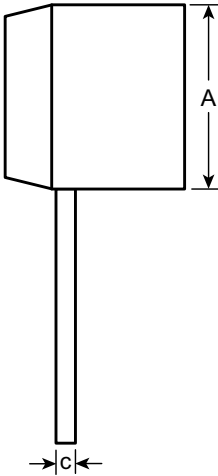

**Side View**

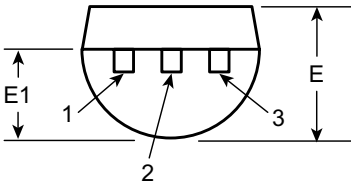

**Bottom View**

Symbol	A	b	c	D	E	E1	e	e1	L	
Dimensions (inches)	MIN	.170	.014 <sup>†</sup>	.014 <sup>†</sup>	.175	.125	.080	.095	.045	.500
	NOM	-	-	-	-	-	-	-	-	-
	MAX	.210	.022 <sup>†</sup>	.022 <sup>†</sup>	.205	.165	.105	.105	.055	.610*

JEDEC Registration TO-92.  
 \* This dimension is not specified in the JEDEC drawing.  
 † This dimension differs from the JEDEC drawing.  
**Drawings not to scale.**  
 Supertex Doc.#: DSPD-3TO92N3, Version E041009.

# 3-Lead TO-243AA (SOT-89) Package Outline (N8)

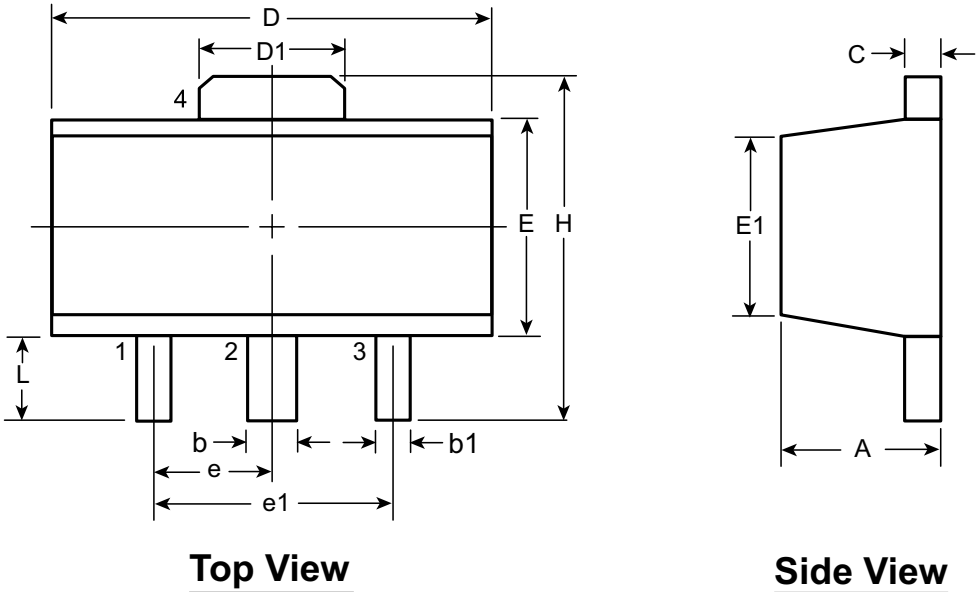

**Top View**

**Side View**

Symbol		A	b	b1	C	D	D1	E	E1	e	e1	H	L		
Dimensions (mm)	MIN	1.40	0.44	0.36	0.35	4.40	1.62	2.29	2.00 <sup>†</sup>	1.50 BSC	3.00 BSC	3.94	0.73 <sup>†</sup>		
	NOM	-	-	-	-	-	-	-	-			-	-	-	-
	MAX	1.60	0.56	0.48	0.44	4.60	1.83	2.60	2.29			4.25	1.20		

JEDEC Registration TO-243, Variation AA, Issue C, July 1986.

<sup>†</sup> This dimension differs from the JEDEC drawing

Drawings not to scale.

Supertex Doc. #: DSPD-3TO243AAN8, Version F111010.

(The package drawing(s) in this data sheet may not reflect the most current specifications. For the latest package outline information go to <http://www.supertex.com/packaging.html>.)

**Supertex inc.** does not recommend the use of its products in life support applications, and will not knowingly sell them for use in such applications unless it receives an adequate "product liability indemnification insurance agreement." **Supertex inc.** does not assume responsibility for use of devices described, and limits its liability to the replacement of the devices determined defective due to workmanship. No responsibility is assumed for possible omissions and inaccuracies. Circuitry and specifications are subject to change without notice. For the latest product specifications refer to the **Supertex inc.** (website: <http://www.supertex.com>)