

IRS21844MPBF HALF-BRIDGE DRIVER

Features

- Floating channel designed for bootstrap operation
- Fully operational to + 600 V
- Tolerant to negative transient voltage, dV/dt immune
- Gate drive supply range from 10 V to 20 V
- Undervoltage lockout for both channels
- 3.3 V and 5 V input logic compatible
- Matched propagation delay for both channels
- Logic and power ground +/- 5 V offset
- Lower di/dt gate driver for better noise immunity
- Output source/sink current capability 1.4 A/1.8 A
- Lead free, RoHS compliant

Product Summary

Topology	Half-Bridge
V_{OFFSET}	600 V
V_{OUT}	10 V – 20 V
$I_{\text{o+}}$ & $I_{\text{o-}}$ (typical)	1.9 A & 2.3 A
t_{on} & t_{off} (typical)	680 ns & 270 ns
Deadtime (typical)	400 ns ($R_{\text{DT}} = 0 \Omega$) 5 μs ($R_{\text{DT}} = 200 \text{ k}\Omega$)

Package Options



MLPQ4x4 16- Leads
(Without 2 leads)

Typical Connection

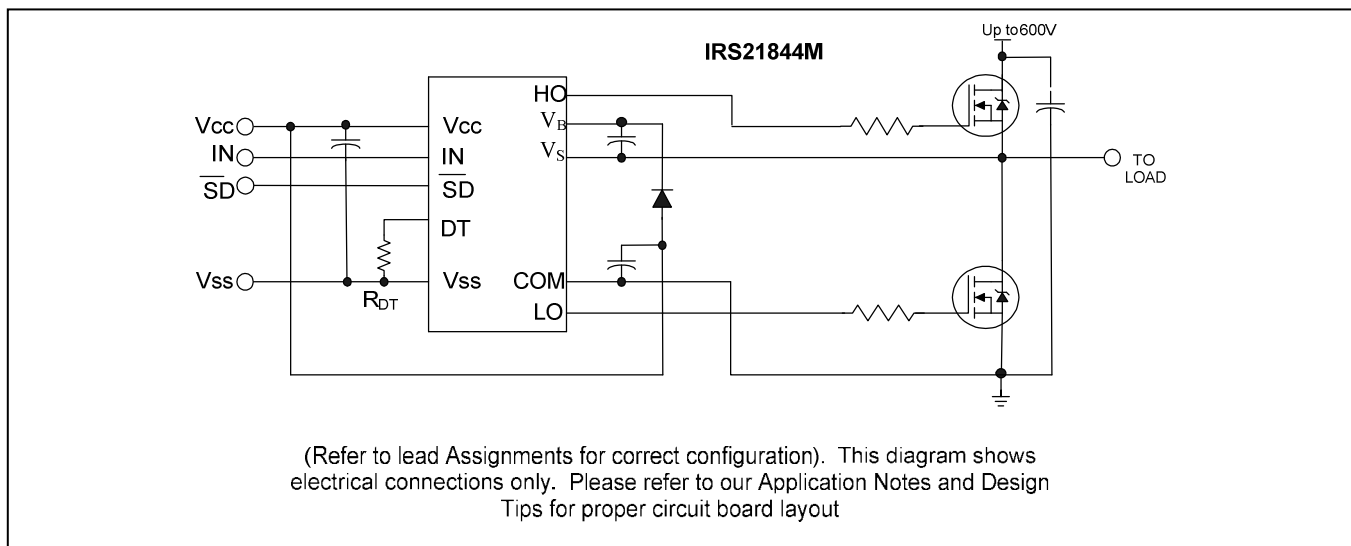

Description

The IRS21844MPBF is a high voltage, high speed power MOSFET and IGBT drivers with dependent high and low-side referenced output channels. Proprietary HVIC and latch immune CMOS technologies enable ruggedized monolithic construction. The logic input is compatible with standard CMOS or LSTTL output, down to 3.3 V logic. The output drivers feature a high pulse current buffer stage designed for minimum driver cross-conduction. The floating channel can be used to drive an N-channel power MOSFET or IGBT in the high-side configuration which operates up to 600 V.

Feature Comparison: IRS2181(4)/IRS2183(4)/IRS2184(4)

Part	Input Logic	Cross-Conduction Prevention logic	Dead-Time	Ground Pins	Ton/Toff
2181	HIN/LIN	no	none	COM	180/220 ns
21814				V _{SS} /COM	
2183	HIN/LIN	yes	Internal 500ns	COM	180/220 ns
21834			Programmable 0.4 – 5 us	V _{SS} /COM	
2184	IN/SD	yes	Internal 500ns	COM	680/270 ns
21844			Programmable 0.4 – 5 us	V _{SS} /COM	

Qualification Information[†]

Qualification Level		Industrial ^{††} (per JEDEC JESD 47)	
		Comments: This IC has passed JEDEC's Industrial qualification. IR's Consumer qualification level is granted by extension of the higher Industrial level.	
Moisture Sensitivity Level		MLPQ4x4 14L	MSL2 ^{†††} (per IPC/JEDEC J-STD-020)
ESD	Machine Model	Class A (+/-100V) (per JEDEC standard JESD22-A115)	
	Human Body Model	Class 1C (+/-1500V) (per EIA/JEDEC standard EIA/JESD22-A114)	
	Charged Device Model	Class III (+/-1000V) (per JEDEC standard JESD22-C101)	
IC Latch-Up Test		Class II, Level A (per JESD78A)	
RoHS Compliant		Yes	

† Qualification standards can be found at International Rectifier's web site <http://www.irf.com/>

†† Higher qualification ratings may be available should the user have such requirements. Please contact your International Rectifier sales representative for further information.

††† Higher MSL ratings may be available for the specific package types listed here. Please contact your International Rectifier sales representative for further information.

Absolute Maximum Ratings

Absolute Maximum Ratings indicate sustained limits beyond which damage to the device may occur. All voltage parameters are absolute voltages referenced to COM. The thermal resistance and power dissipation ratings are measured under board mounted and still air conditions.

Symbol	Definition	Min	Max	Units
V_B	High-side floating absolute voltage	-0.3	620	V
V_S	High-side floating supply offset voltage	$V_B - 25$	$V_B + 0.3$	
V_{HO}	High-side floating output voltage	$V_S - 0.3$	$V_B + 0.3$	
V_{CC}	Low-side and logic fixed supply voltage	-0.3	20 [†]	
V_{LO}	Low-side output voltage	-0.3	$V_{CC} + 0.3$	
DT	Programmable deadtime pin voltage	$V_{SS} - 0.3$	$V_{CC} + 0.3$	
V_{IN}	Logic input voltage (IN & \overline{SD})	$V_{SS} - 0.3$	$V_{CC} + 0.3$	
V_{SS}	Logic ground	$V_{CC} - 20$	$V_{CC} + 0.3$	
dV_S/dt	Allowable offset supply voltage transient	—	50	
P_D	Package power dissipation @ $T_A \leq 25^\circ\text{C}$	—	2.08	W
R_{thJA}	Thermal resistance, junction to ambient	—	36	$^\circ\text{C}/\text{W}$
T_J	Junction temperature	—	150	$^\circ\text{C}$
T_S	Storage temperature	-50	150	
T_L	Lead temperature (soldering, 10 seconds)	—	300	

† All supplies are fully tested at 25 V and an internal 20 V clamp exists for each supply.

Recommended Operating Conditions

The input/output logic timing diagram is shown in Figure 1. For proper operation the device should be used within the recommended conditions. The V_S and V_{SS} offset rating are tested with all supplies biased at a 15 V differential.

Symbol	Definition	Min	Max	Units
V_B	High-side floating supply absolute voltage	$V_S + 10$	$V_S + 20$	V
V_S	High-side floating supply offset voltage	(††)	600	
V_{HO}	High-side floating output voltage	V_S	V_B	
V_{CC}	Low-side and logic fixed supply voltage	10	20	
V_{LO}	Low-side output voltage	0	V_{CC}	
V_{IN}	Logic input voltage (IN & \overline{SD}) (†††)	V_{SS}	V_{CC}	
DT	Programmable deadtime pin voltage	V_{SS}	V_{CC}	
V_{SS}	Logic ground	-5	5	
T_A	Ambient temperature	-40	125	$^\circ\text{C}$

†† Logic operational for V_S of -5 V to +600 V. Logic state held for V_S of -5 V to $-V_{BS}$. (Please refer to Design Tip DT97-3 for more details).

††† HIN and LIN are internally clamped with a 5.2 V zener diode.

Dynamic Electrical Characteristics

V_{BIAS} (V_{CC} , V_{BS}) = 15 V, V_{SS} = COM, C_L = 1000 pF, T_A = 25°C, $DT = V_{SS}$ unless otherwise specified.

Symbol	Definition	Min	Typ	Max	Units	Test Conditions
t_{on}	Turn-on propagation delay	—	680	900	ns	$V_S = 0$ V
t_{off}	Turn-off propagation delay	—	270	400		$V_S = 0$ V or 600 V
t_{sd}	Shut-down propagation delay	—	180	270		
MT_{on}	Delay matching, HS & LS turn-on	—	0	90		
MT_{off}	Delay matching, HS & LS turn-off	—	0	40		
t_r	Turn-on rise time	—	40	60		$V_S = 0$ V
t_f	Turn-off fall time	—	20	35		
DT	Deadtime: LO turn-off to HO turn-on (DT_{LO-HO}) & HO turn-off to LO turn-on (DT_{HO-LO})	280	400	520	μ s	$R_{DT} = 0$ Ω
		4	5	6		$R_{DT} = 200$ k Ω
MDT	Deadtime matching $DT_{LO-HO} - DT_{HO-LO}$	—	0	50	ns	$R_{DT} = 0$ Ω
		—	0	600		$R_{DT} = 200$ k Ω

Static Electrical Characteristics

V_{BIAS} (V_{CC} , V_{BS}) = 15 V, V_{SS} = COM, $DT = V_{SS}$ and $T_A = 25^\circ\text{C}$ unless otherwise specified. The V_{IL} , V_{IH} and I_{IN} parameters are referenced to V_{SS}/COM and are applicable to the respective input leads: IN and \overline{SD} . The V_O , I_O and R_{on} parameters are referenced to COM and are applicable to the respective output leads: HO and LO.

Symbol	Definition	Min	Typ	Max	Units	Test Conditions
V_{IH}	Logic "1" input voltage for HO & logic "0" for LO	2.5	—	—	V	$V_{CC} = 10$ V to 20 V
V_{IL}	Logic "0" input voltage for HO & logic "1" for LO	—	—	0.8		
$V_{SD,TH+}$	\overline{SD} input positive going threshold	2.5	—	—		
$V_{SD,TH-}$	\overline{SD} input negative going threshold	—	—	0.8		
V_{OH}	High level output voltage, $V_{BIAS} - V_O$	—	—	1.4		$I_O = 0$ A
V_{OL}	Low level output voltage, V_O	—	—	0.2		$I_O = 20$ mA
I_{LK}	Offset supply leakage current	—	—	50	μ A	$V_B = V_S = 600$ V
I_{QBS}	Quiescent V_{BS} supply current	20	60	150	mA	$V_{IN} = 0$ V or 5 V
I_{QCC}	Quiescent V_{CC} supply current	0.4	1.0	1.6		
I_{IN+}	Logic "1" input bias current	—	25	60	μ A	$IN = 5$ V, $\overline{SD} = 0$ V
I_{IN-}	Logic "0" input bias current	—	—	5.0		$IN = 0$ V, $\overline{SD} = 5$ V
V_{CCUV+} V_{BSUV+}	V_{CC} and V_{BS} supply undervoltage positive going threshold	8.0	8.9	9.8	V	
V_{CCUV-} V_{BSUV-}	V_{CC} and V_{BS} supply undervoltage negative going threshold	7.4	8.2	9.0		
V_{CCUVH} V_{BSUVH}	Hysteresis	0.3	0.7	—		
I_{O+}	Output high short circuit pulsed current	1.4	1.9	—	A	$V_O = 0$ V, $PW \leq 10$ μ s
I_{O-}	Output low short circuit pulsed current	1.8	2.3	—		$V_O = 15$ V, $PW \leq 10$ μ s

Functional Block Diagram: IRS21844

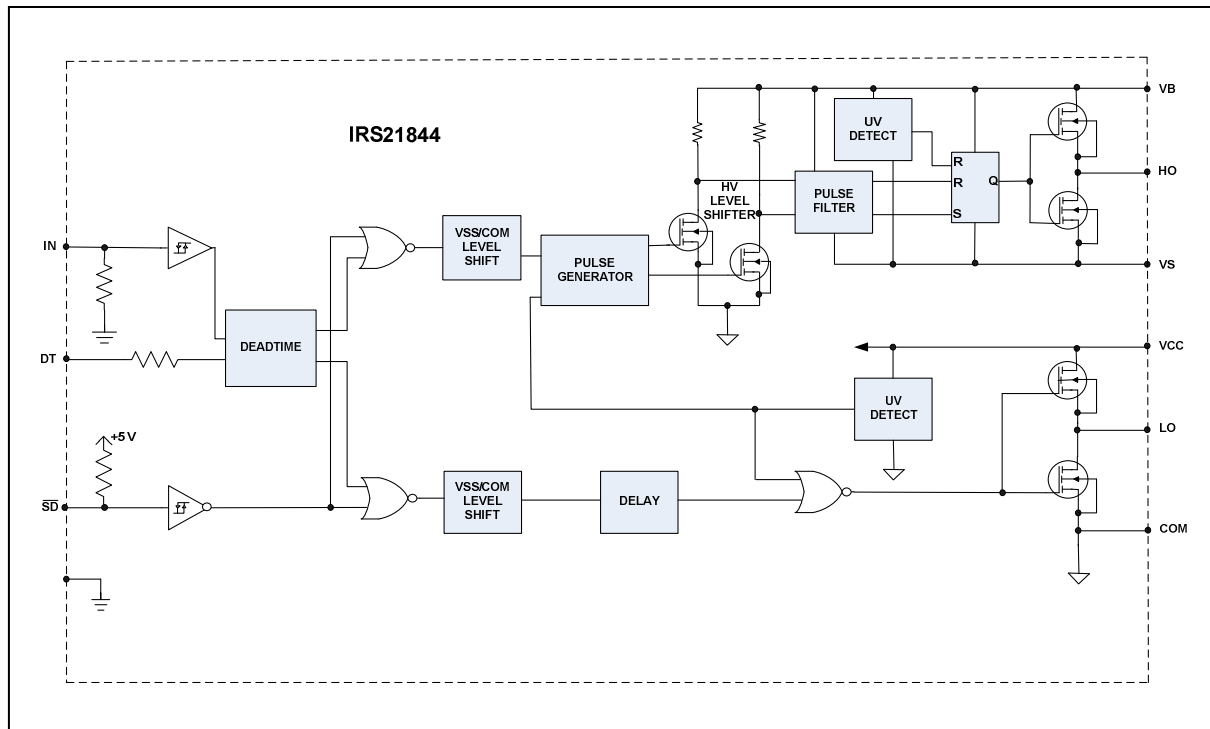

Input/Output Pin Equivalent Circuit Diagrams: IRS21844

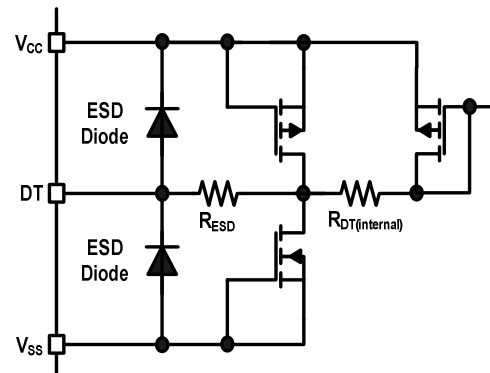
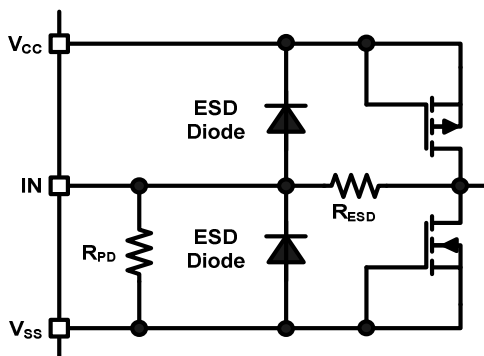
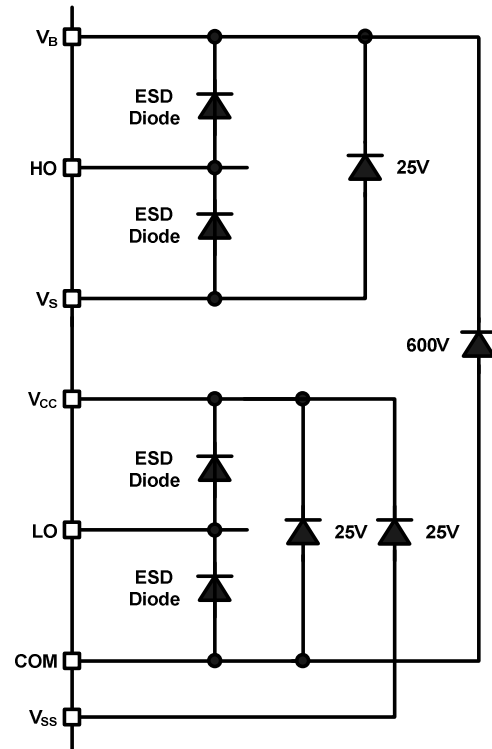
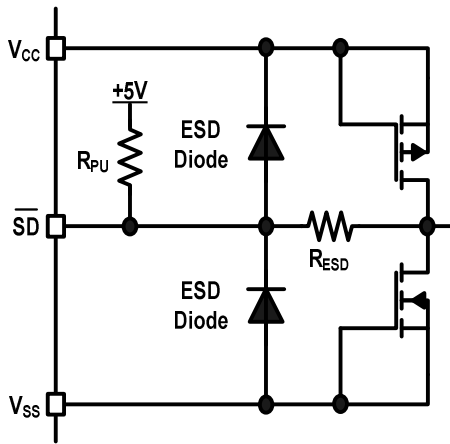

Lead Definitions

PIN	Symbol	Description
1	\overline{SD}	Logic input for shutdown (referenced to V_{SS})
2	V_{SS}	Logic ground
3	DT	Programmable deadtime lead, referenced to V_{SS}
4	COM	Low-side return
5	LO	Low-side gate drive output
6	NC	No Connection
7	V_{CC}	Low-side and logic fixed supply
8	NC	No Connection
9	NC	No Connection
10	NC	No Connection (removed lead)
11	V_S	High-side floating supply return
12	HO	High-side gate drive output
13	V_B	High-side floating supply
14	NC	No Connection
15	NC	No Connection (removed lead)
16	IN	Logic input for high-side gate driver output (HO), in phase

Lead Assignments: IRS21844

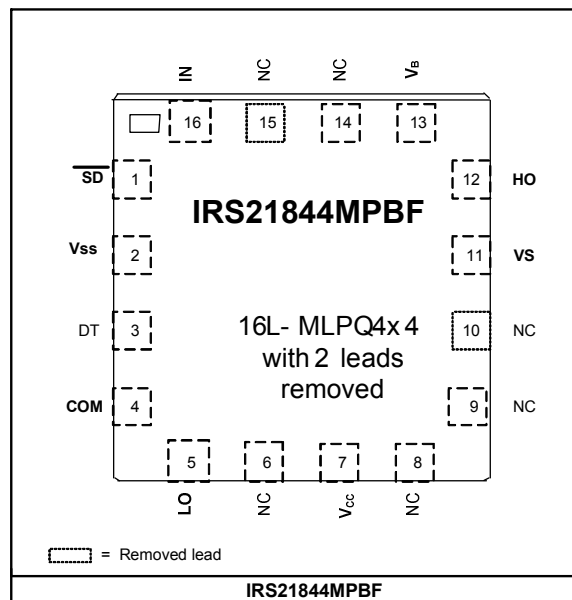

Application Information and Additional Details

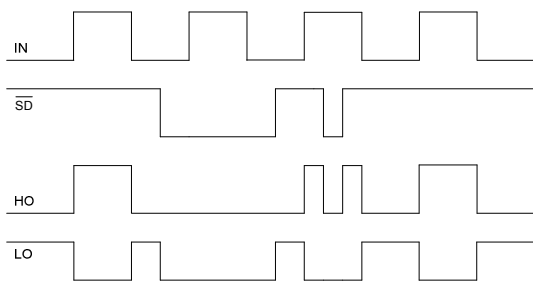

Figure 1: Input/Output Timing Diagram

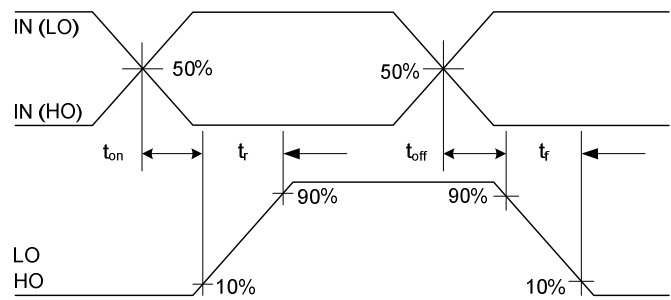

Figure 2: Switching Time Waveform Definitions

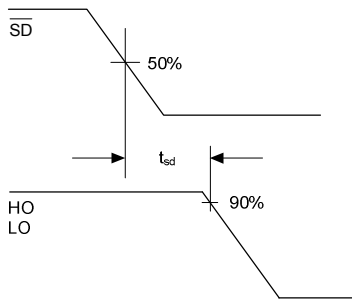

Figure 3: Shutdown Waveform Definitions

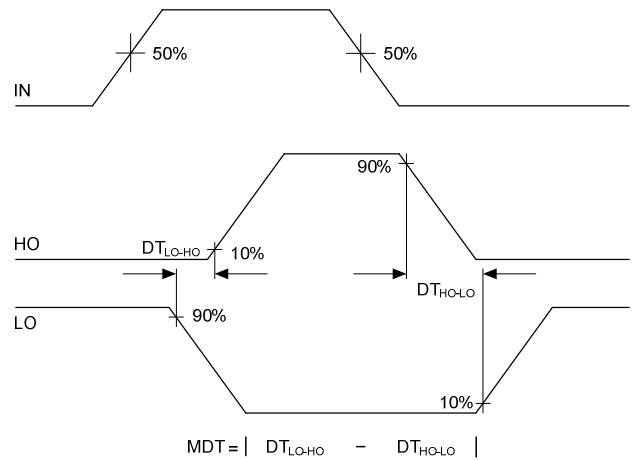

Figure 4: Deadtime Waveform Definitions

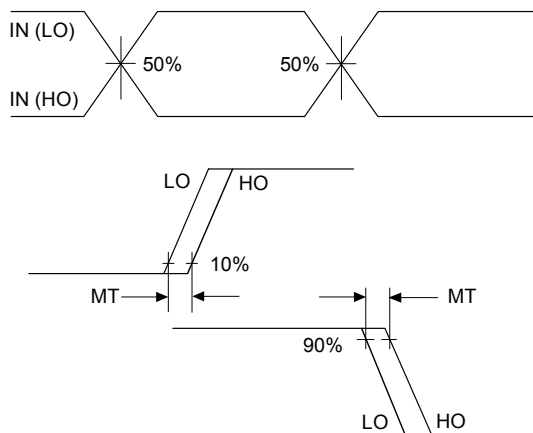

Figure 5: Delay Matching Waveform Definitions

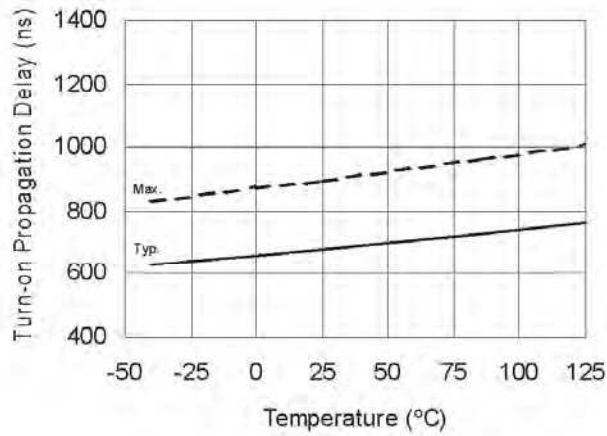

Figure 6A. Turn-On Propagation Delay vs. Temperature

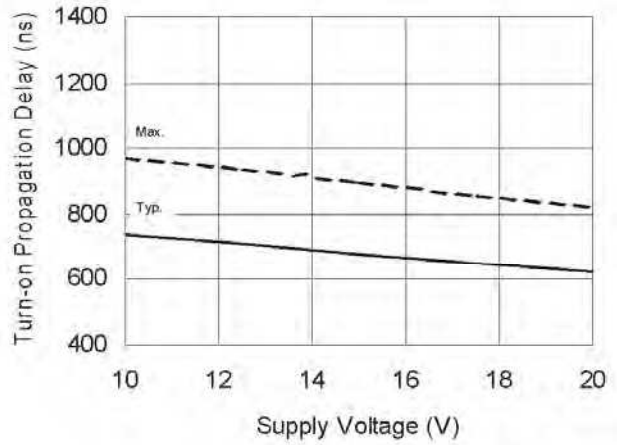

Figure 6B. Turn-On Propagation Delay vs. Supply Voltage

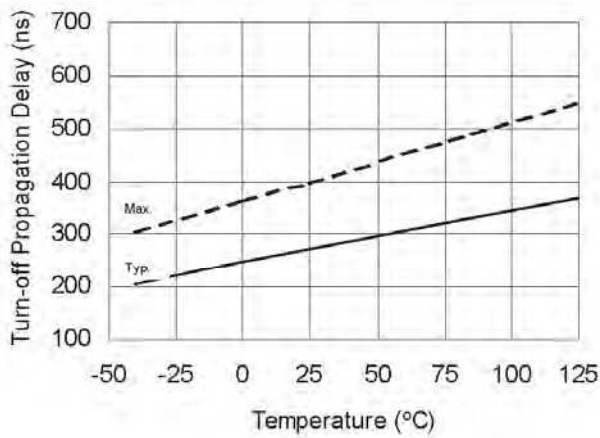

Figure 7A. Turn-Off Propagation Delay vs. Temperature

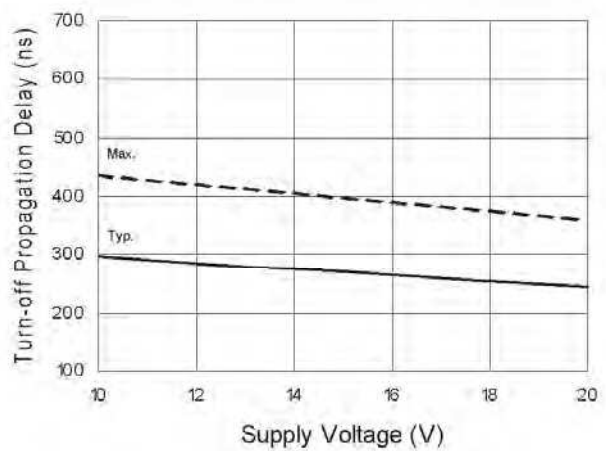

Figure 7B. Turn-Off Propagation Delay vs. Supply Voltage

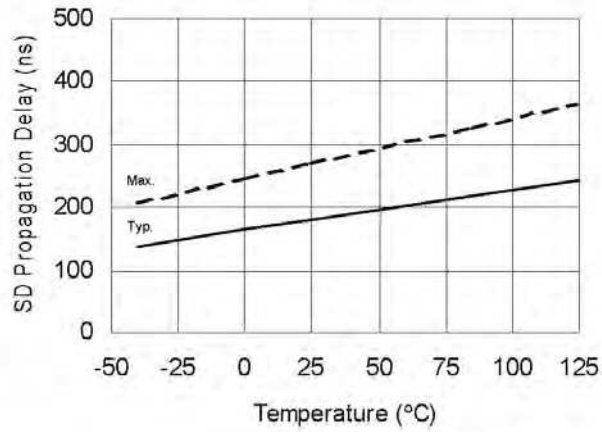

Figure 8A. SD Propagation Delay vs. Temperature

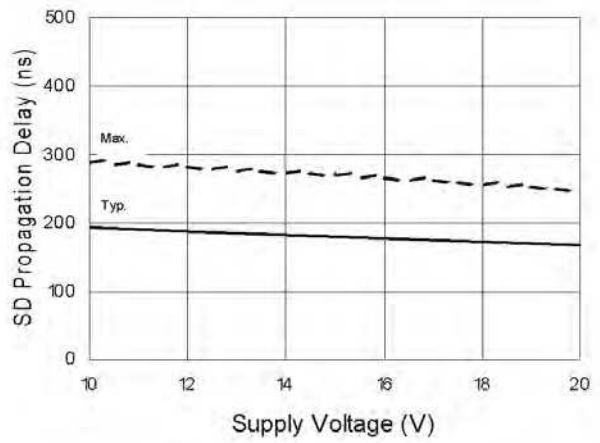

Figure 8B. SD Propagation Delay vs. Supply Voltage

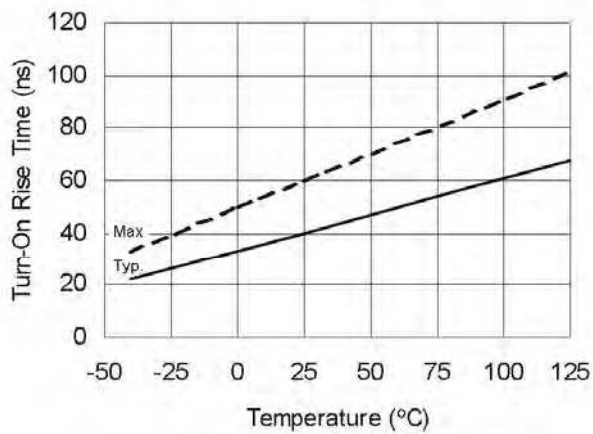

Figure 9A. Turn-On Rise Time vs. Temperature

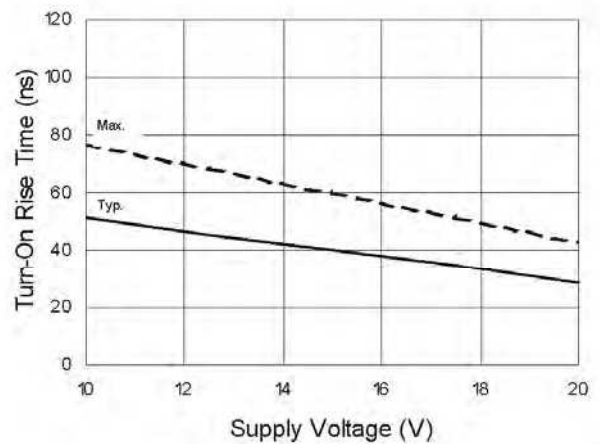

Figure 9B. Turn-On Rise Time vs. Supply Voltage

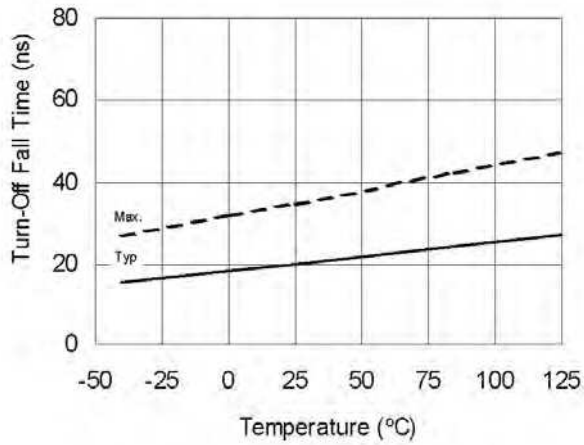

Figure 10A. Turn-Off Fall Time vs. Temperature

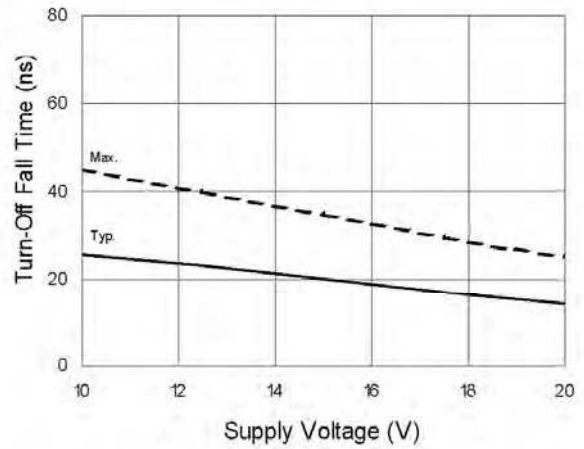

Figure 10B. Turn-Off Fall Time vs. Supply Voltage

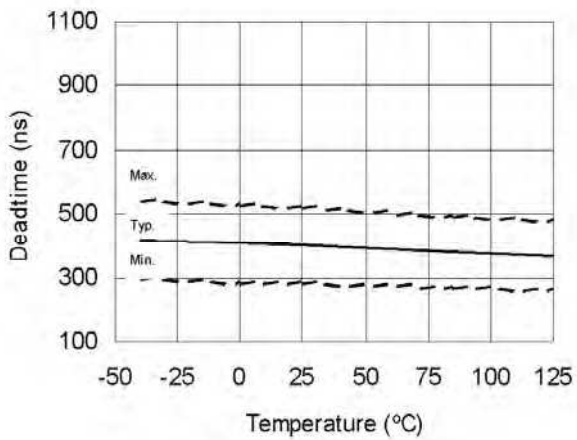

Figure 11A. Deadtime vs. Temperature

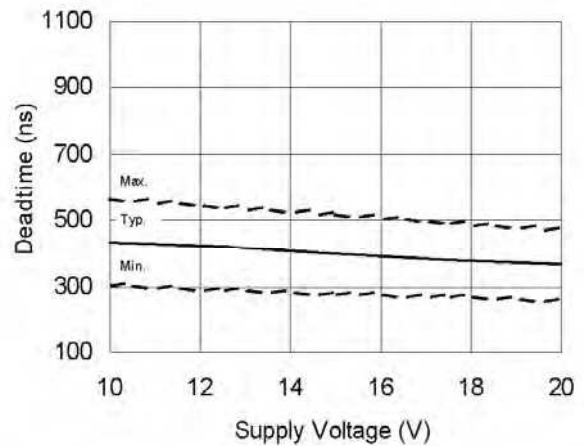

Figure 11B. Deadtime vs. Supply Voltage

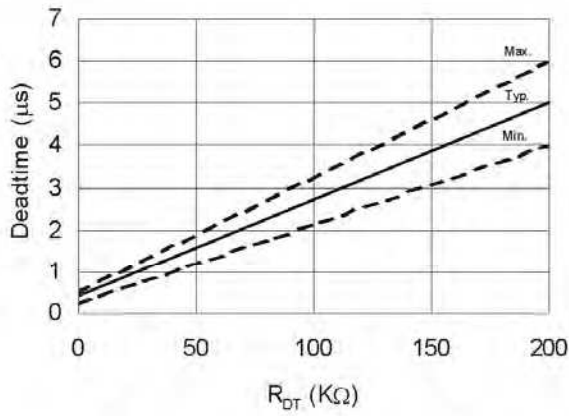

Figure 11C. Deadtime vs. R_{DT}

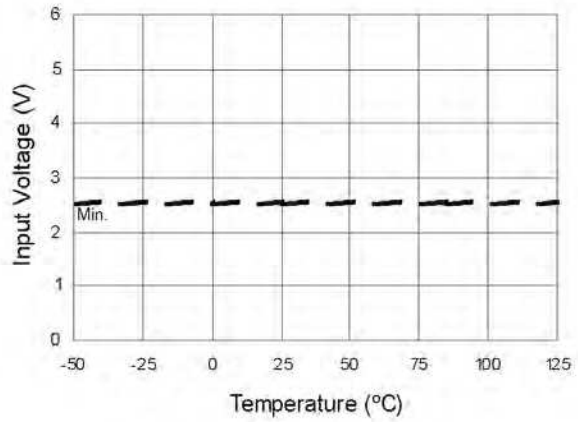

Figure 12A. Logic "1" Input Voltage vs. Temperature

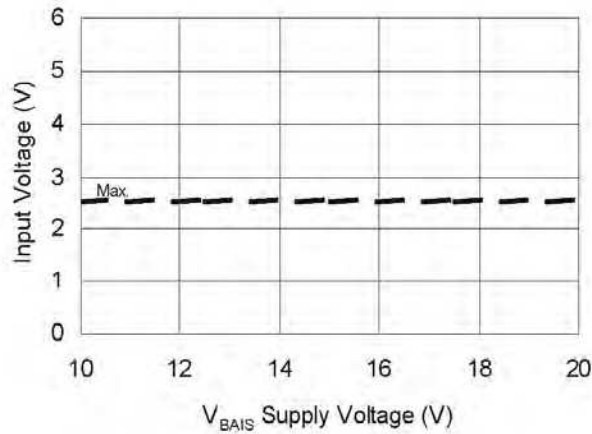

Figure 12B. Logic "1" Input Voltage vs. Supply Voltage

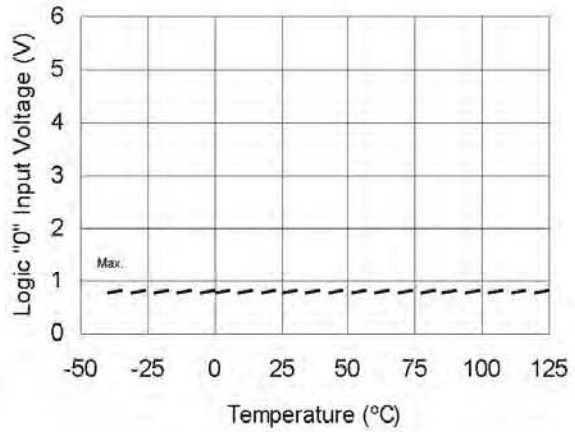

Figure 13A. Logic "0" Input Voltage vs. Temperature

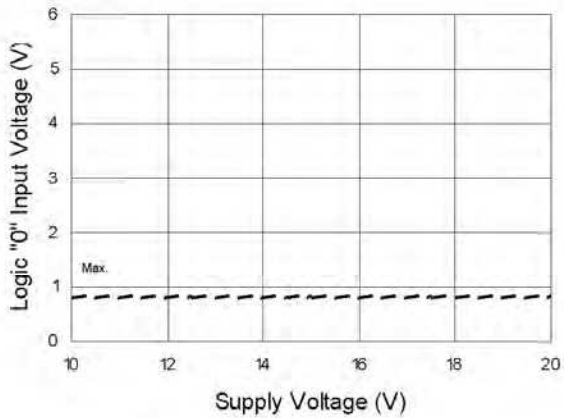

Figure 13B. Logic "0" Input Voltage vs. Supply Voltage

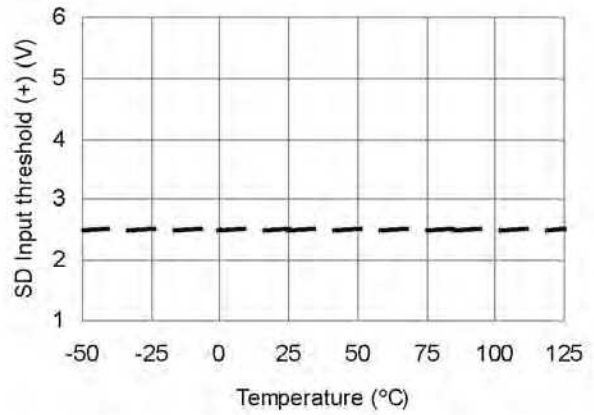

Figure 14A. SD input positive going threshold (+) vs. Temperature

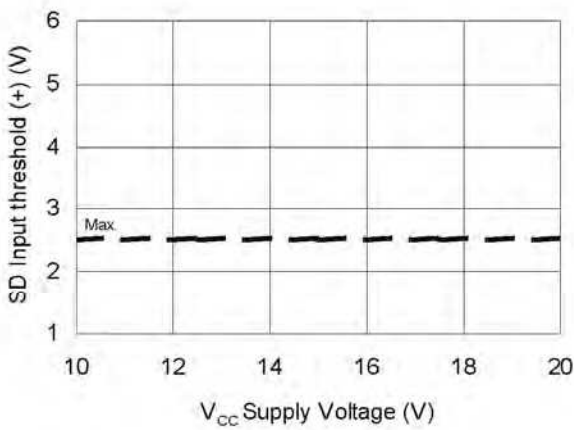

Figure 14B. SD input positive going threshold (+) vs. Supply Voltage

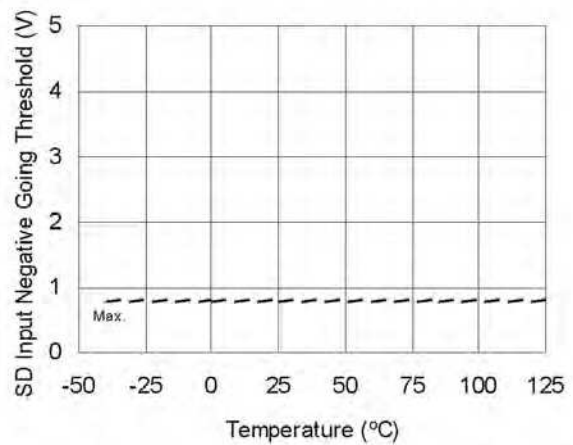

Figure 15A. SD Input Negative Going Threshold vs. Temperature

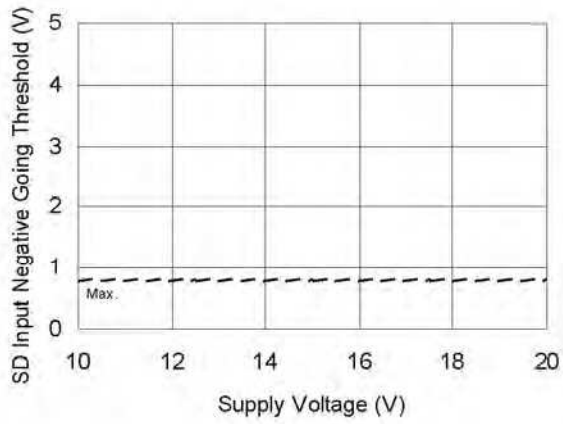

Figure 15B. SD Input Negative Going Threshold vs. Supply Voltage

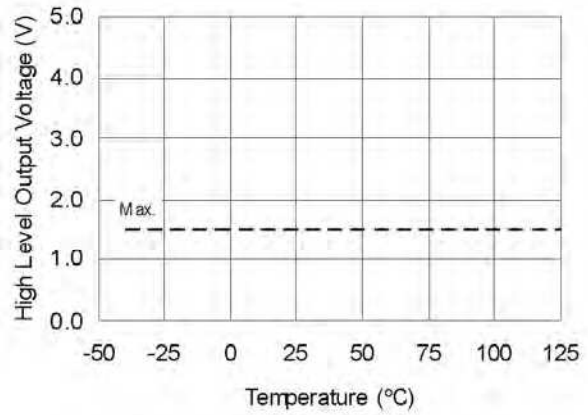

Figure 16A. High Level Output Voltage vs. Temperature (I_O = 0 mA)

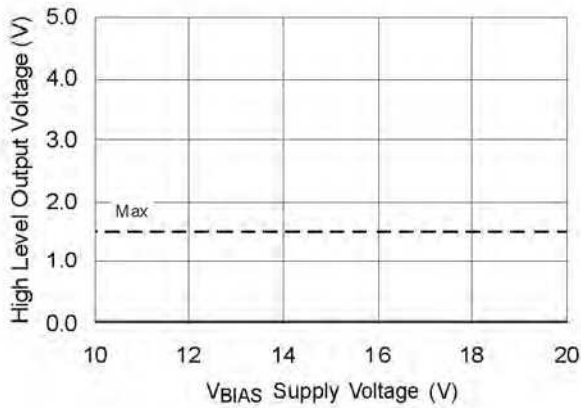

Figure 16B. High Level Output Voltage vs. Supply Voltage (I_O = 0 mA)

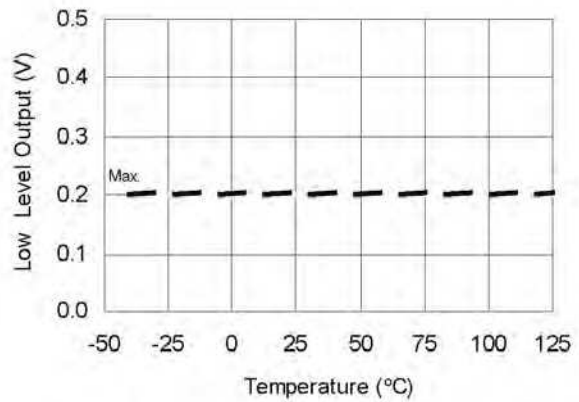

Figure 17A. Low Level Output vs. Temperature

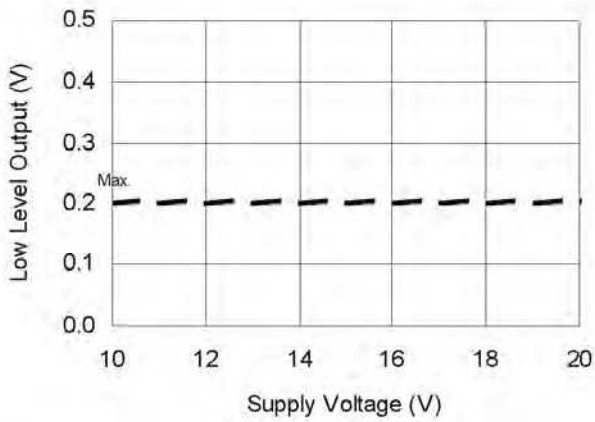

Figure 17B. Low Level Output vs. Supply Voltage

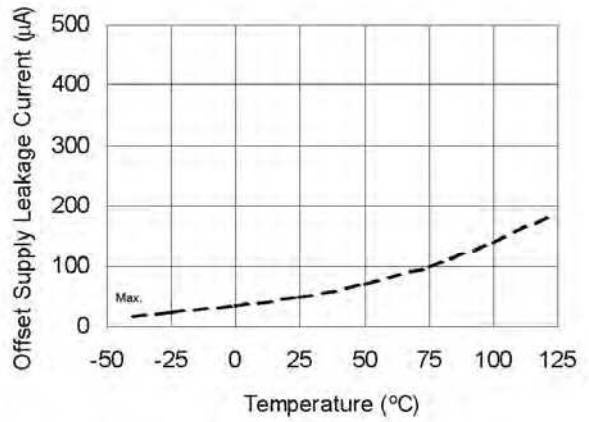

Figure 18A. Offset Supply Leakage Current vs. Temperature

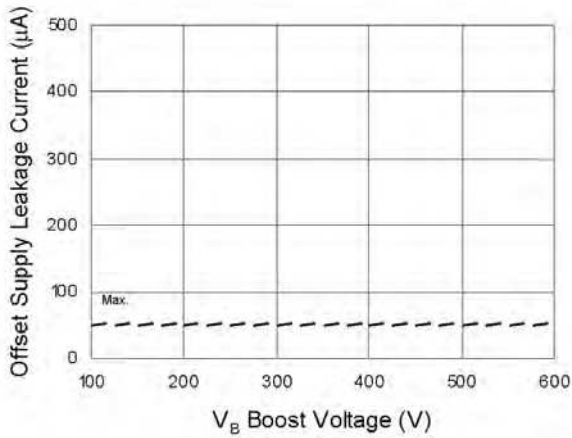

Figure 18B. Offset Supply Leakage Current vs. V_B Boost Voltage

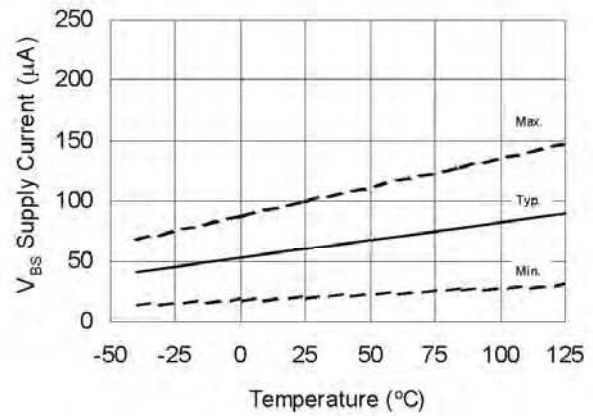

Figure 19A. V_{BS} Supply Current vs. Temperature

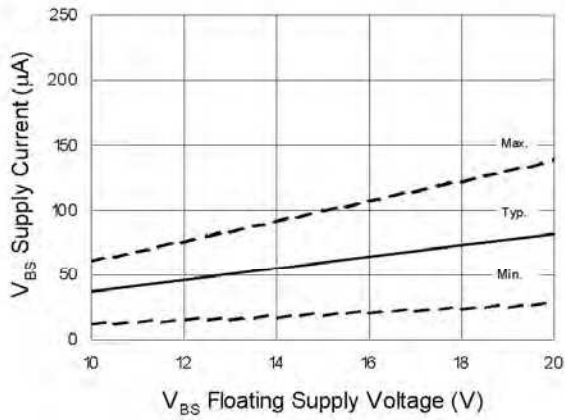

Figure 19B. V_{BS} Supply Current vs. V_{BS} Floating Supply Voltage

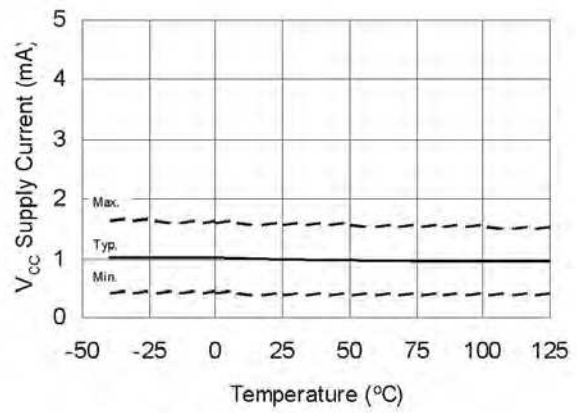

Figure 20A. V_{CC} Supply Current vs. Temperature

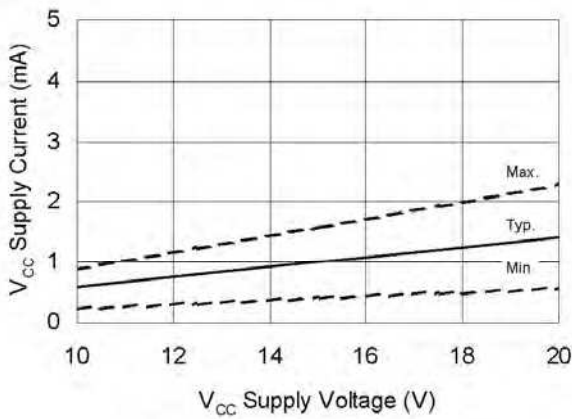

Figure 20B. V_{CC} Supply Current vs. V_{CC} Supply Voltage

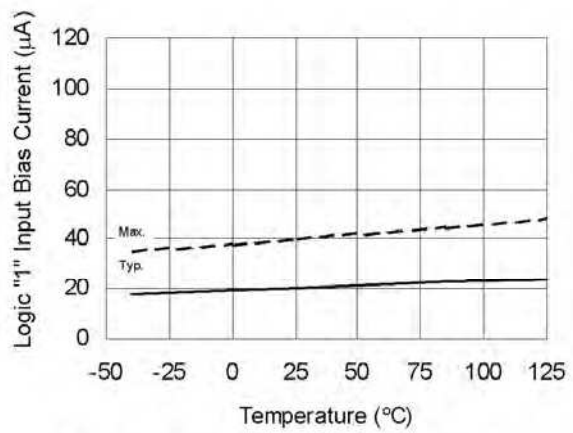

Figure 21A. Logic "1" Input Bias Current vs. Temperature

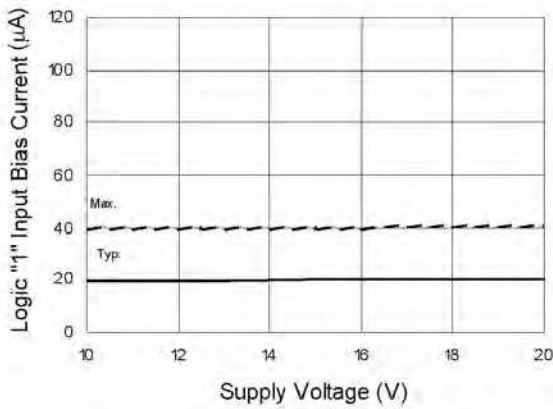

Figure 21B. Logic "1" Input Bias Current vs. Supply Voltage

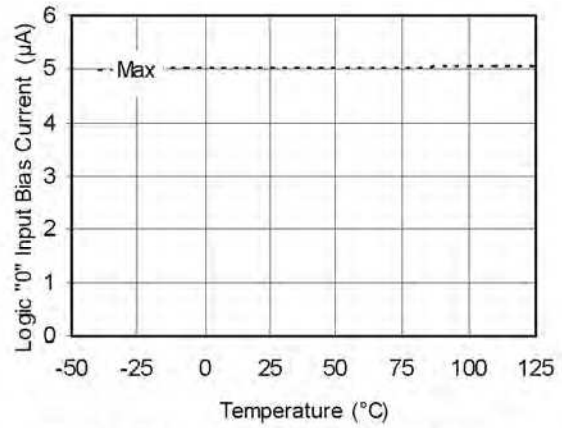

Figure 22A. Logic "0" Input Bias Current vs. Temperature

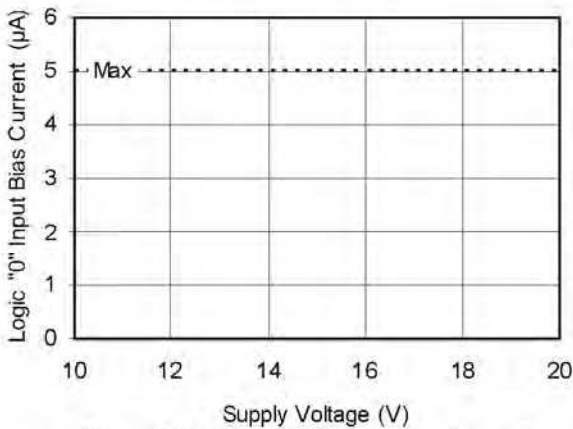

Figure 22B. Logic "0" Input Bias Current vs. Voltage

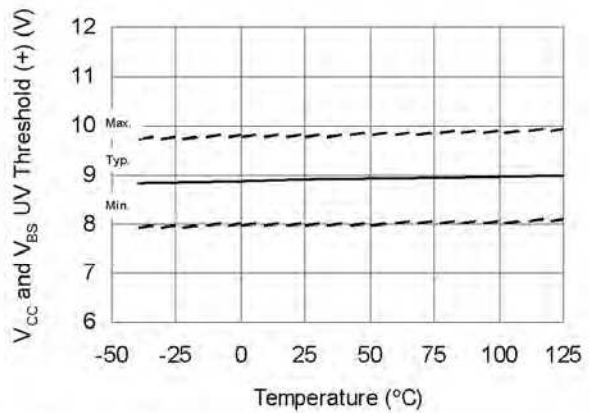

Figure 23. V_{CC} and V_{BS} Undervoltage Threshold (+) vs. Temperature

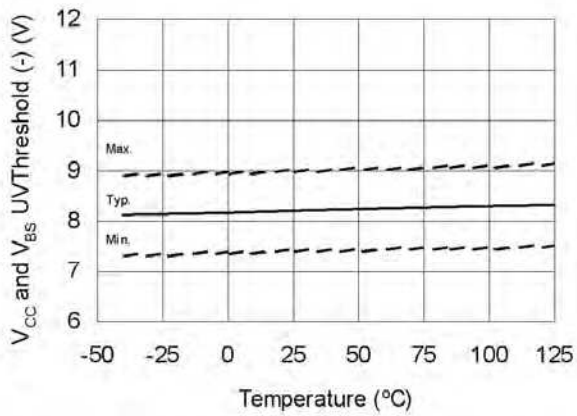

Figure 24. V_{CC} and V_{BS} Undervoltage Threshold (-) vs. Temperature

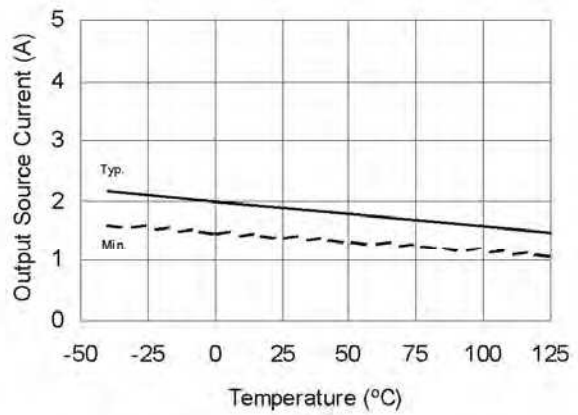

Figure 25A. Output Source Current vs. Temperature

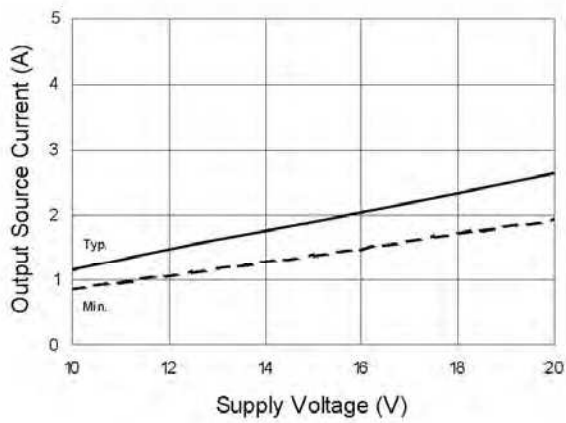

Figure 25B. Output Source Current vs. Supply Voltage

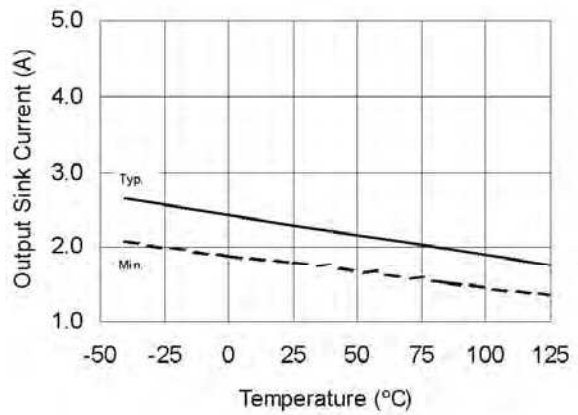

Figure 26A. Output Sink Current vs. Temperature

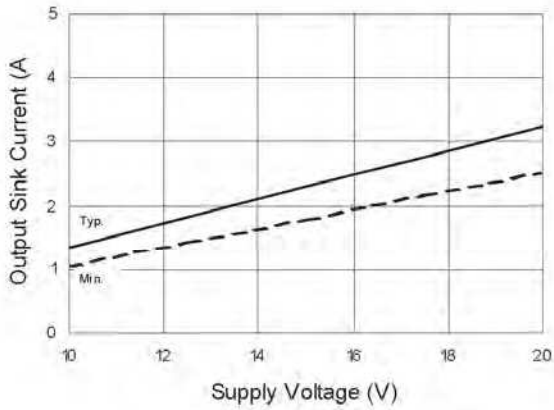

Figure 26B. Output Sink Current vs. Supply Voltage

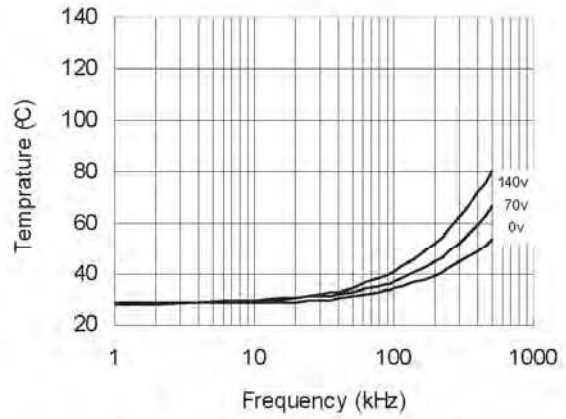

Figure 27. IRS2181 vs. Frequency (IRFBC20), $R_{gate}=33 \Omega$, $V_{CC}=15 V$

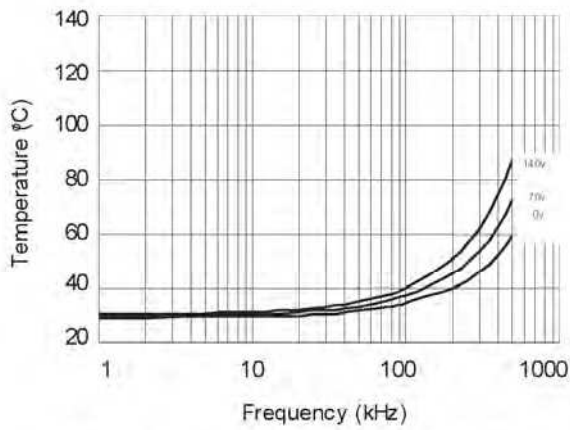

Figure 28. IRS2181 vs. Frequency (IRFBC30), $R_{gate}=22 \Omega$, $V_{CC}=15 V$

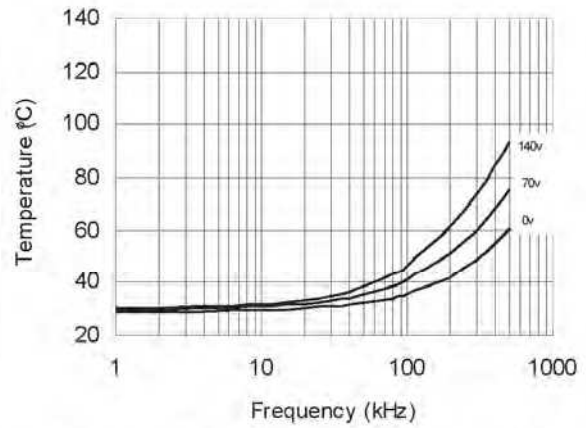
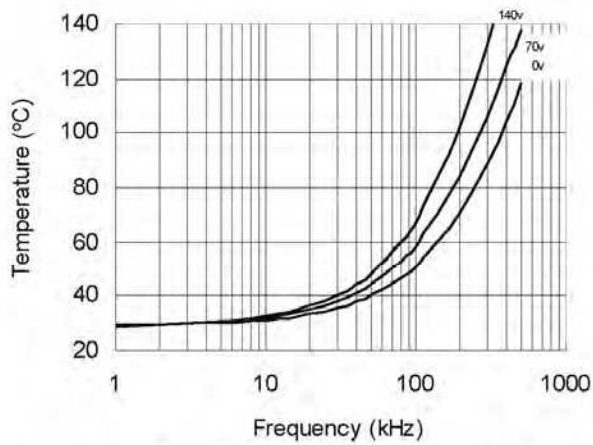
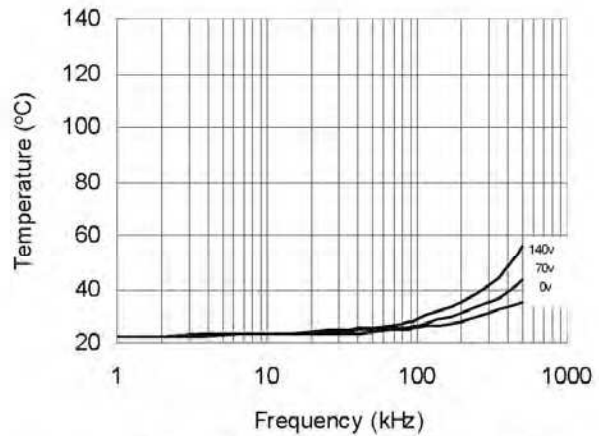

Figure 29. IRS2181 vs. Frequency (IRFBC40), $R_{gate}=15 \Omega$, $V_{CC}=15 V$



**Figure 30. IRS2181 vs. Frequency (IRFPE50),
 $R_{gate}=10 \Omega, V_{CC}=15 V$**



**Figure 31. IRS21814 vs. Frequency (IRFBC20),
 $R_{gate}=33 \Omega, V_{CC}=15 V$**

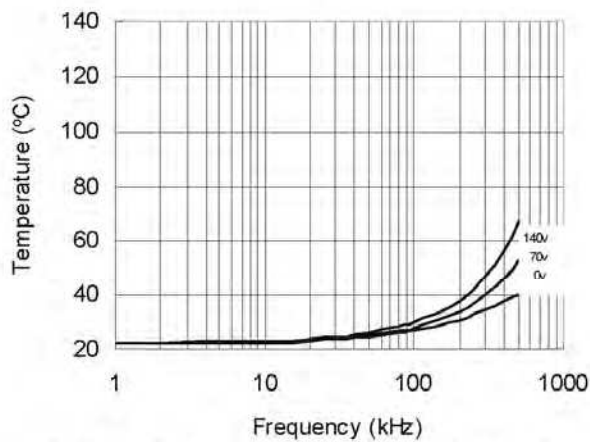

**Figure 32. IRS21814 vs. Frequency (IRFBC30),
 $R_{gate}=22 \Omega, V_{CC}=15 V$**

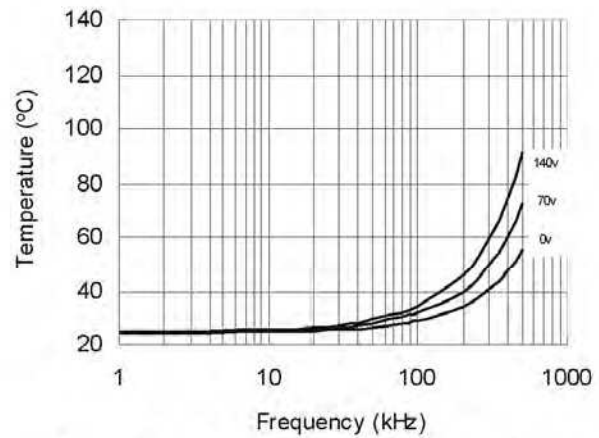

**Figure 33. IRS21814 vs. Frequency (IRFBC40),
 $R_{gate}=15 \Omega, V_{CC}=15 V$**

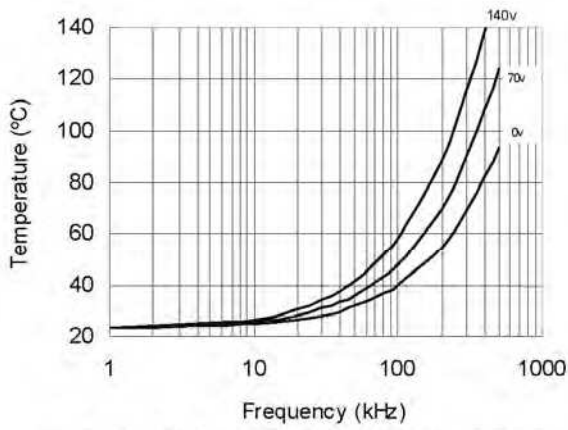

**Figure 34. IRS21814 vs. Frequency (IRFPE50),
 $R_{gate}=10 \Omega, V_{CC}=15 V$**

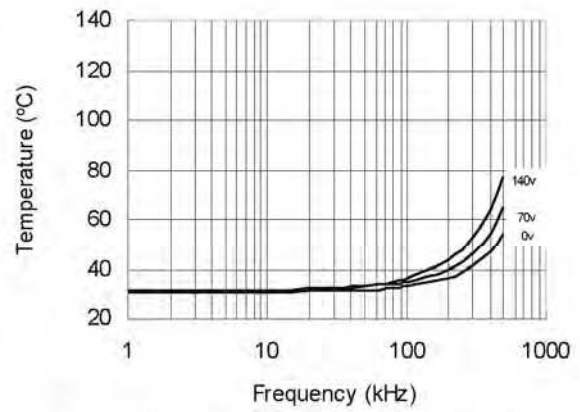

**Figure 35. IRS2181s vs. Frequency (IRFBC20),
 $R_{gate}=33 \Omega, V_{CC}=15 V$**

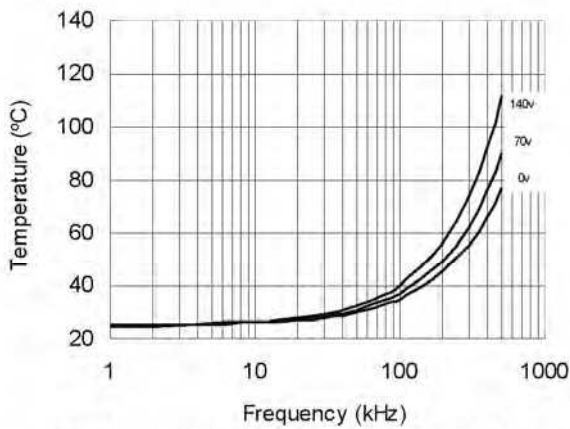

**Figure 36. IRS2181s vs. Frequency (IRFBC30),
 $R_{gate}=22 \Omega, V_{CC}=15 V$**

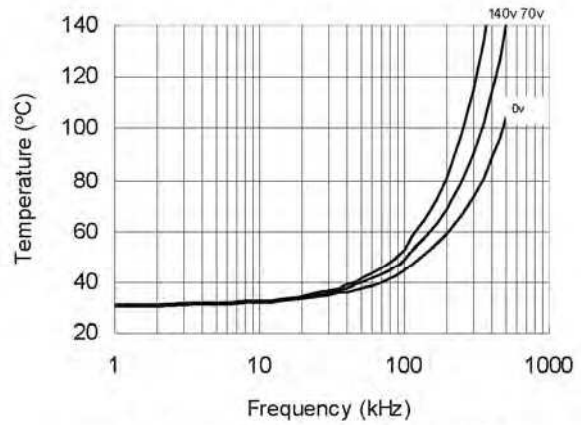

**Figure 37. IRS2181s vs. Frequency (IRFBC40),
 $R_{gate}=15 \Omega, V_{CC}=15 V$**

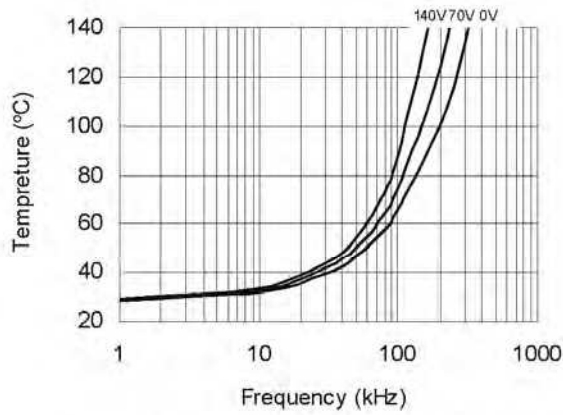

Figure 38. IRS2181s vs. Frequency (IRFPE50),
 $R_{gate}=10 \Omega$, $V_{CC}=15 V$

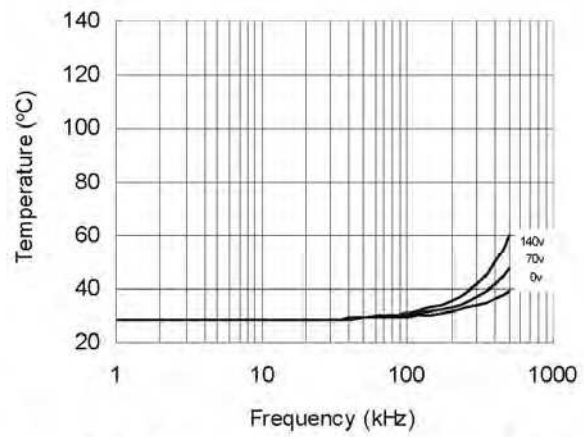

Figure 39. IRS21814s vs. Frequency (IRFBC20),
 $R_{gate}=33 \Omega$, $V_{CC}=15 V$

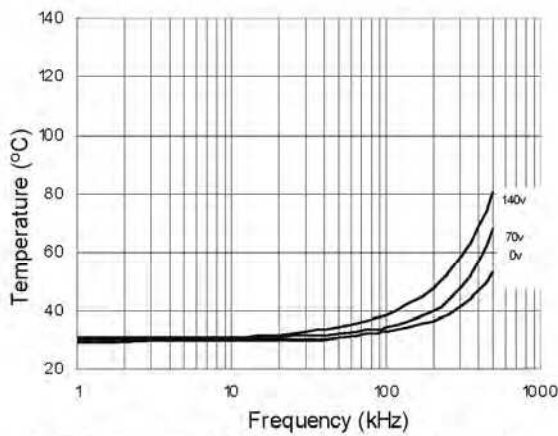

Figure 40. IRS21814s vs. Frequency (IRFBC30),
 $R_{gate}=22 \Omega$, $V_{CC}=15 V$

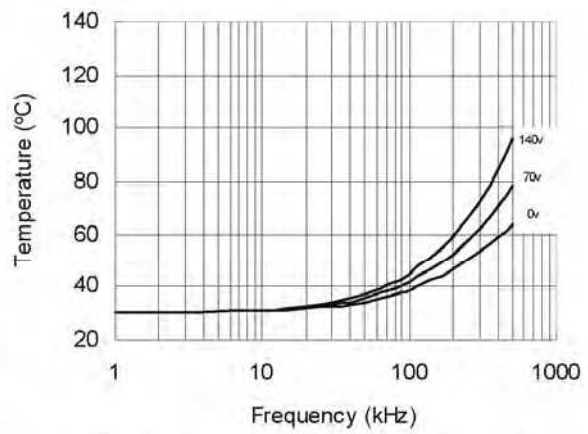
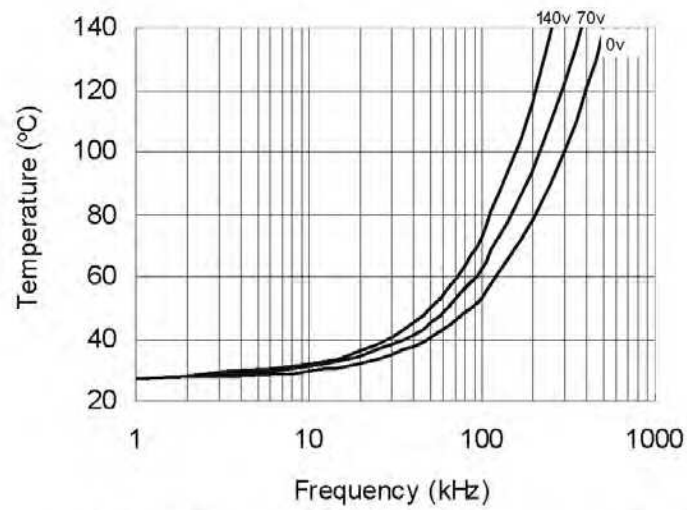
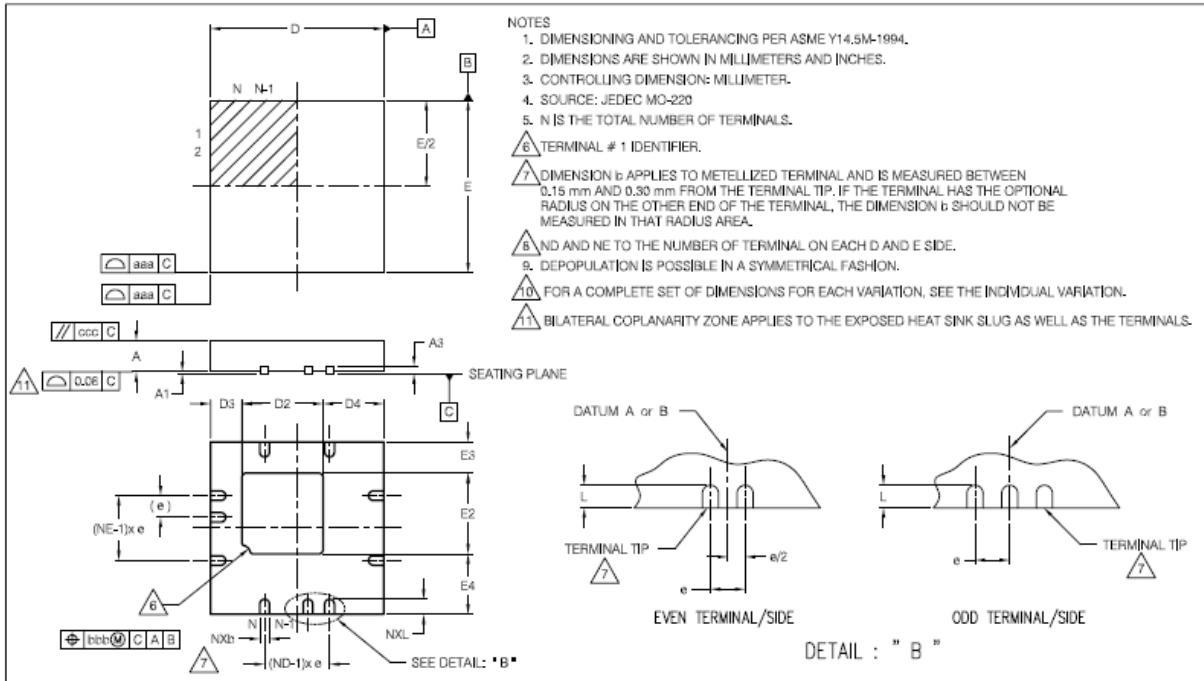

Figure 41. IRS21814s vs. Frequency (IRFBC40),
 $R_{gate}=15 \Omega$, $V_{CC}=15 V$



**Figure 42. IRS21814s vs. Frequency (IRFPE50),
 $R_{gate}=10 \Omega$, $V_{CC}=15 V$**

Package Details: MLPQ 4x4 -16L



SYMBOL	VGGD-10					
	MILLIMETERS			INCHES		
	MIN	NOM	MAX	MIN	NOM	MAX
A	0.90	0.90	1.00	.032	.035	.039
A1	0.00	0.02	0.05	.000	.0008	.0019
A3	0.20 REF			.008 REF		
b	0.18	0.25	0.30	.007	.010	.012
D2	1.78	1.88	1.98	.070	.074	.078
D3	0.73 REF			.029 REF		
D4	1.40 REF			.055 REF		
D	4.00 BSC			.157 BSC		
E	4.00 BSC			.157 BSC		
E4	1.40 REF			.055 REF		
E3	0.73 REF			.029 REF		
E2	1.78	1.88	1.98	.070	.074	.078
L	0.30	0.40	0.50	.012	.016	.020
e	0.50 PITCH			.020 PITCH		
N	16			16		
ND	4			4		
NE	4			4		
aaa	0.15			.0059		
bbb	0.10			.0039		
ccc	0.10			.0039		
ddd	0.05			.0019		

Tape and Reel Details: MLPQ 4x4

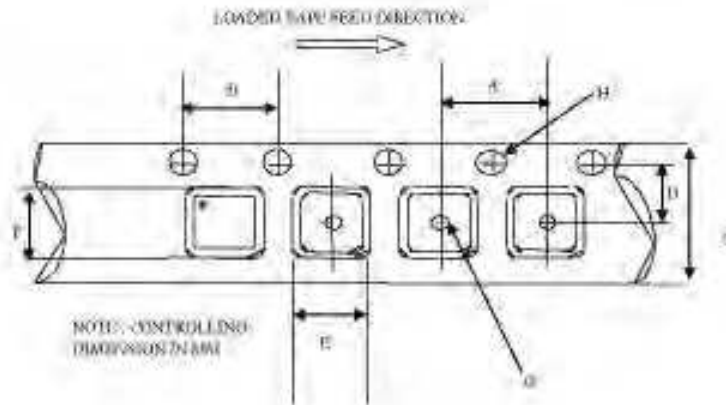

CARRIER TAPE DIMENSION FOR MLPQ4X4V

Code	Metric		Imperial	
	Min	Max	Min	Max
A	7.90	8.10	0.311	0.358
B	3.80	4.10	0.154	0.161
C	14.70	12.30	0.461	0.484
D	5.45	5.55	0.215	0.219
E	4.25	4.45	0.168	0.176
F	4.25	4.45	0.168	0.176
G	1.50	n/a	0.059	n/a
H	1.50	1.60	0.059	0.063

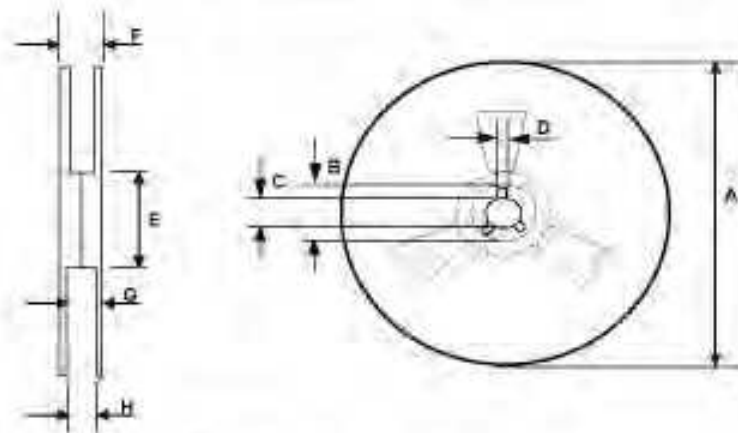

REEL DIMENSIONS FOR MLPQ4X4V

Code	Metric		Imperial	
	Min	Max	Min	Max
A	329.60	350.25	12.976	13.801
B	20.95	21.45	0.824	0.844
C	12.50	13.20	0.508	0.519
D	1.95	2.45	0.767	0.096
E	98.00	102.00	3.858	4.015
F	n/a	16.40	n/a	0.724
G	14.50	17.10	0.570	0.673
H	12.40	14.40	0.488	0.566

Part Marking Information

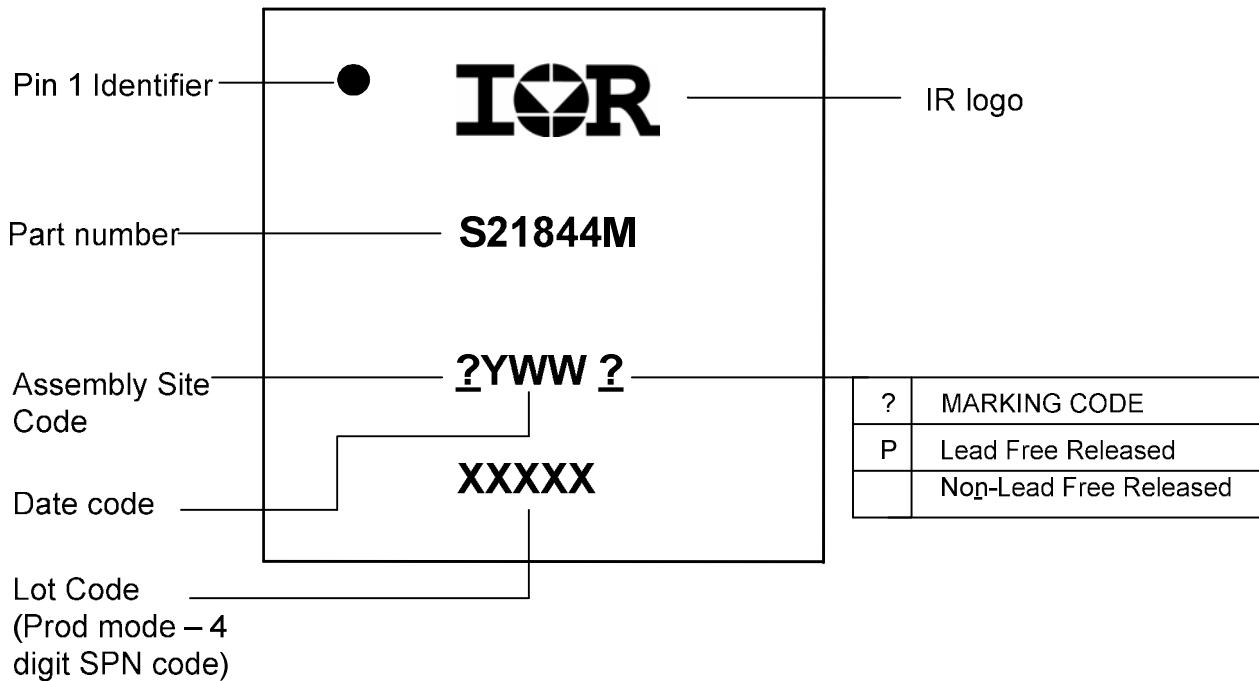

Ordering Information

Base Part Number	Package Type	Standard Pack		Complete Part Number
		Form	Quantity	
IRS21844	MLPQ 4x4-16L	Tube/Bulk	92	IRS21844MPBF
		<i>Tape and Reel</i>	<i>3,000</i>	IRS21844MTRPBF

The information provided in this document is believed to be accurate and reliable. However, International Rectifier assumes no responsibility for the consequences of the use of this information. International Rectifier assumes no responsibility for any infringement of patents or of other rights of third parties which may result from the use of this information. No license is granted by implication or otherwise under any patent or patent rights of International Rectifier. The specifications mentioned in this document are subject to change without notice. This document supersedes and replaces all information previously supplied.

For technical support, please contact IR's Technical Assistance Center

<http://www.irf.com/technical-info/>

WORLD HEADQUARTERS:

233 Kansas St., El Segundo, California 90245
 Tel: (310) 252-7105