

# DIGITRON SEMICONDUCTORS

MBR3035WT-MBR3045WT

30A SCHOTTKY RECTIFIER

## MAXIMUM RATINGS

Rating	Symbol	MBR		Unit
		3035WT	3045WT	
Peak repetitive reverse voltage Working peak reverse voltage DC blocking voltage	$V_{RRM}$ $V_{RWM}$ $V_R$	35	45	V
Average rectified forward current (Rated $V_R$ )	$I_{F(AV)}$	30 @ $T_C = 105^\circ\text{C}$		A
Peak repetitive forward current (Rated $V_R$ , square wave, 20 kHz)	$I_{FRM}$	30		A
Peak repetitive reverse surge current (2.0 $\mu\text{s}$ , 1.0 kHz)	$I_{RRM}$	2		A
Non-repetitive peak surge current (surge applied at rated load conditions, halfwave, single phase, 60Hz)	$I_{FSM}$	200		A
Operating junction temperature range	$T_J$	-65 to +150		$^\circ\text{C}$
Storage junction temperature range	$T_{stg}$	-65 to +175		$^\circ\text{C}$
Peak surge junction temperature (forward current applied)	$T_{J(pk)}$	175		$^\circ\text{C}$
Voltage rate of change (Rated $V_R$ )	$dv/dt$	10		V/ns
Maximum thermal resistance Junction to case Junction to ambient	$R_{\theta JC}$ $R_{\theta JA}$	1.4 40		$^\circ\text{C}/\text{W}$

## ELECTRICAL CHARACTERISTICS ( $T_C = 25^\circ\text{C}$ unless otherwise noted)

Parameter	Symbol	MBR		Unit
		3035WT	3045WT	
Maximum instantaneous forward voltage <sup>(1)</sup> ( $I_F = 20\text{A}$ , $T_C = 125^\circ\text{C}$ ) ( $I_F = 30\text{A}$ , $T_C = 125^\circ\text{C}$ ) ( $I_F = 30\text{A}$ , $T_C = 25^\circ\text{C}$ )	$V_F$	0.6 0.72 0.76		V
Maximum instantaneous reverse current <sup>(1)</sup> (Rated dc voltage, $T_C = 125^\circ\text{C}$ ) (Rated dc voltage, $T_C = 25^\circ\text{C}$ )	$I_R$	100 1.0		mA

Note 1: Pulse test: Pulse width = 300 $\mu\text{s}$ , duty cycle  $\leq$  2.0%.

## MECHANICAL CHARACTERISTICS

Case	TO-247
Marking	Alpha-numeric
Pin out	See below

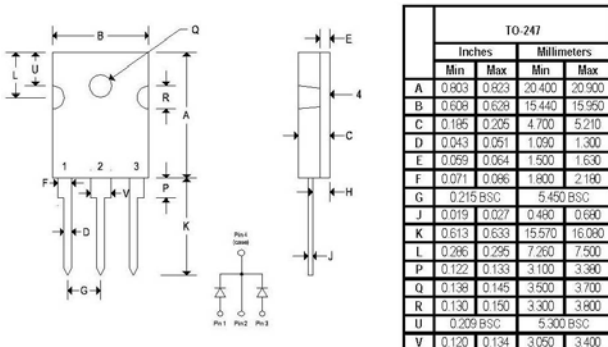

# DIGITRON SEMICONDUCTORS

MBR3035WT-MBR3045WT

30A SCHOTTKY RECTIFIER

Available Non-RoHS (standard) or RoHS compliant (add PBF suffix).  
 Available as "HR" (high reliability) screened per MIL-PRF-19500, JANTX level. Add "HR" suffix to base part number.

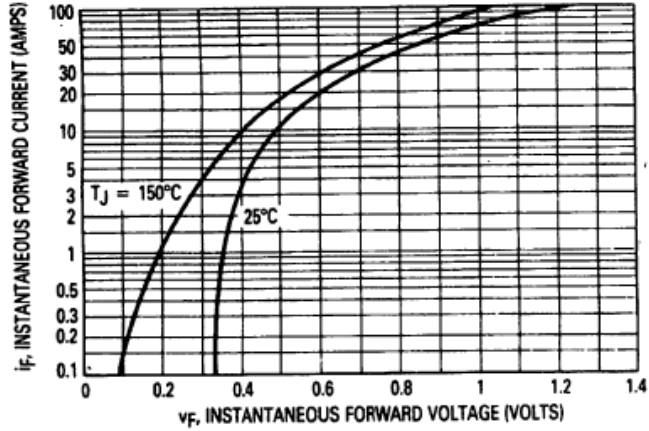

Figure 1. Typical Forward Voltage

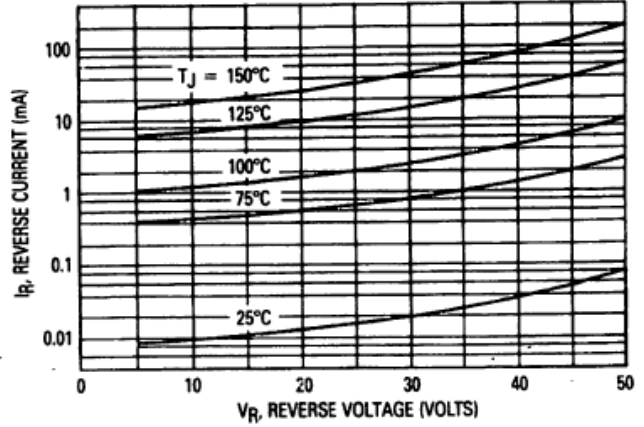

Figure 2. Typical Reverse Current

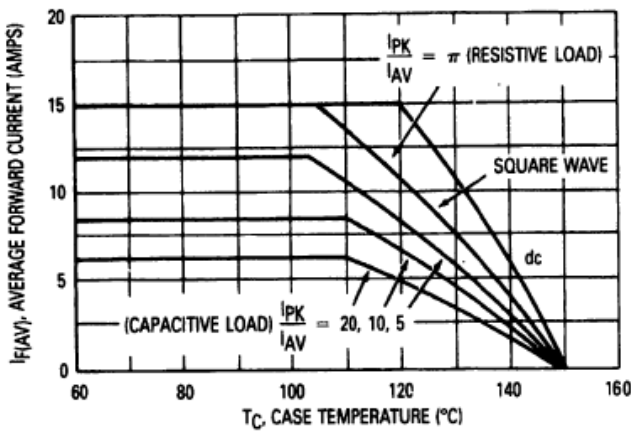

Figure 3. Current Derating (Per Leg)

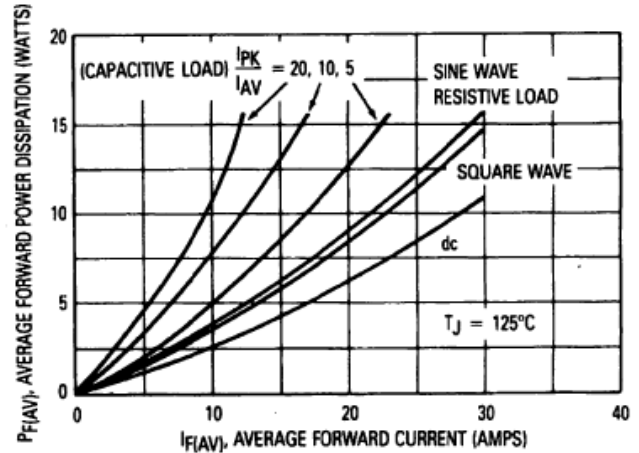

Figure 4. Forward Power Dissipation (Per Leg)

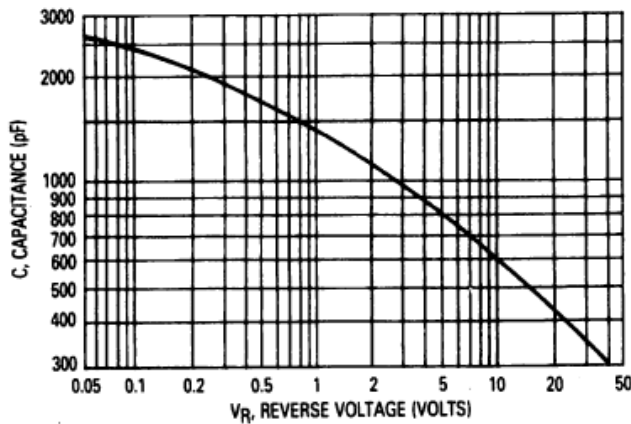

Figure 5. Capacitance

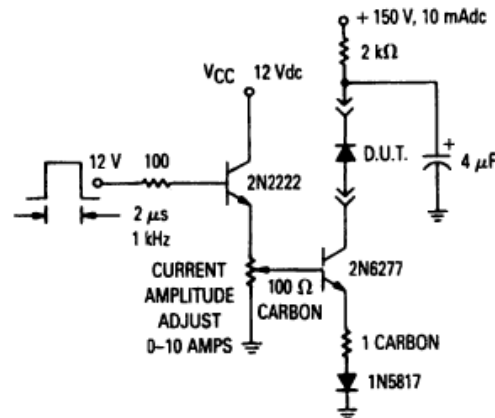

Figure 6. Test Circuit For Repetitive Reverse Current