

# Six-Pack XPT IGBT

 $V_{CES} = 1200\text{ V}$ 
 $I_{C25} = 60\text{ A}$ 
 $V_{CE(sat)} = 1.8\text{ V}$ 

**Part name** (Marking on product)

MIXA40W1200TML

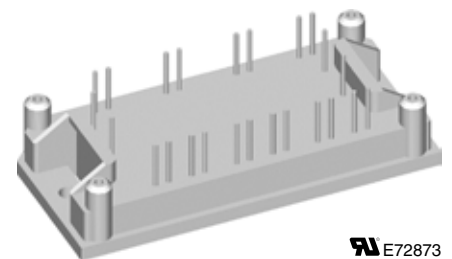
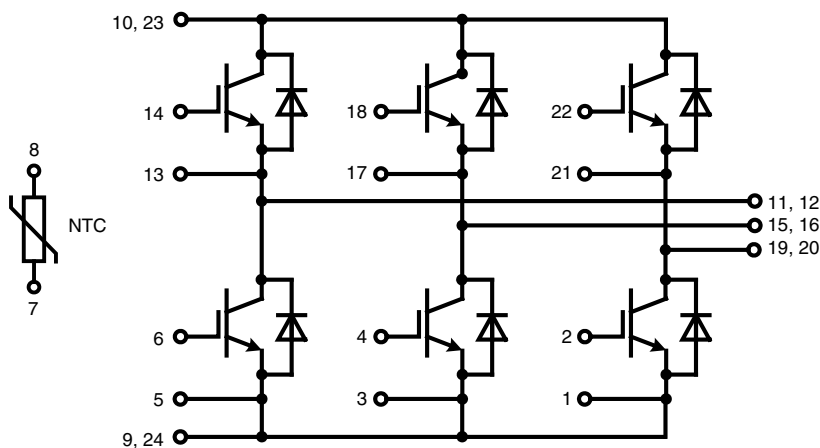

E72873

Pin configuration see outlines.

**Features:**

- High level of integration
- Rugged XPT design (Xtreme light Punch Through) results in:
  - short circuit rated for 10  $\mu\text{sec}$ .
  - very low gate charge
  - square RBSOA @ 3x  $I_C$
  - low EMI
- Thin wafer technology combined with the XPT design results in a competitive low  $V_{CE(sat)}$
- Temperature sense included
- SONIC™ diode
  - fast and soft reverse recovery
  - low operating forward voltage

**Application:**

- AC motor drives
- Pumps, Fans
- Washing machines
- Air-conditioning system
- Inverter and power supplies

**Package:**

- E1 package
- Assembly height is 17.1 mm
- Insulated base plate
- Pins suitable for wave soldering and PCB mounting
- UL registered E72873

**IGBT T1 - T6**

Symbol	Definitions	Conditions	Ratings			Unit	
			min.	typ.	max.		
$V_{CES}$	collector emitter voltage		$T_{VJ} = 25^{\circ}\text{C}$		1200	V	
$V_{GES}$	max. DC gate voltage	continuous			$\pm 20$	V	
$V_{GEM}$	max. transient collector gate voltage	transient			$\pm 30$	V	
$I_{C25}$	collector current		$T_C = 25^{\circ}\text{C}$		60	A	
$I_{C80}$			$T_C = 80^{\circ}\text{C}$		40	A	
$P_{tot}$	total power dissipation		$T_C = 25^{\circ}\text{C}$		195	W	
$V_{CE(sat)}$	collector emitter saturation voltage	$I_C = 35\text{ A}; V_{GE} = 15\text{ V}$	$T_{VJ} = 25^{\circ}\text{C}$ $T_{VJ} = 125^{\circ}\text{C}$	1.8 2.1	2.1	V V	
$V_{GE(th)}$	gate emitter threshold voltage	$I_C = 1.5\text{ mA}; V_{GE} = V_{CE}$	$T_{VJ} = 25^{\circ}\text{C}$	5.4	5.9	6.5	V
$I_{CES}$	collector emitter leakage current	$V_{CE} = V_{CES}; V_{GE} = 0\text{ V}$	$T_{VJ} = 25^{\circ}\text{C}$ $T_{VJ} = 125^{\circ}\text{C}$	0.02 0.3	0.15	mA mA	
$I_{GES}$	gate emitter leakage current	$V_{GE} = \pm 20\text{ V}$			500	nA	
$Q_{G(on)}$	total gate charge	$V_{CE} = 600\text{ V}; V_{GE} = 15\text{ V}; I_C = 35\text{ A}$			106	nC	
$t_{d(on)}$	turn-on delay time	inductive load $V_{CE} = 600\text{ V}; I_C = 35\text{ A}$ $V_{GE} = \pm 15\text{ V}; R_G = 27\ \Omega$	$T_{VJ} = 125^{\circ}\text{C}$	70		ns	
$t_r$	current rise time			40		ns	
$t_{d(off)}$	turn-off delay time			250		ns	
$t_f$	current fall time			100		ns	
$E_{on}$	turn-on energy per pulse			3.8		mJ	
$E_{off}$	turn-off energy per pulse			4.1		mJ	
<b>RBSOA</b>	reverse bias safe operating area	$V_{GE} = \pm 15\text{ V}; R_G = 27\ \Omega; V_{CEK} = 1200\text{ V}$	$T_{VJ} = 125^{\circ}\text{C}$		105	A	
<b><math>I_{SC}</math> (SCSOA)</b>	short circuit safe operating area	$V_{CE} = 900\text{ V}; V_{GE} = \pm 15\text{ V};$ $R_G = 27\ \Omega; t_p = 10\ \mu\text{s};$ non-repetitive	$T_{VJ} = 125^{\circ}\text{C}$		140	A	
$R_{thJC}$	thermal resistance junction to case	(per IGBT)			0.21	0.64	K/W K/W
$R_{thCH}$	thermal resistance case to heatsink						

**Diode D1 - D6**

Symbol	Definitions	Conditions	Ratings			Unit	
			min.	typ.	max.		
$V_{RRM}$	max. repetitive reverse voltage		$T_{VJ} = 25^{\circ}\text{C}$		1200	V	
$I_{F25}$	forward current		$T_C = 25^{\circ}\text{C}$		44	A	
$I_{F80}$			$T_C = 80^{\circ}\text{C}$		29	A	
$V_F$	forward voltage	$I_F = 30\text{ A}; V_{GE} = 0\text{ V}$	$T_{VJ} = 25^{\circ}\text{C}$ $T_{VJ} = 125^{\circ}\text{C}$	1.95 1.95	2.2	V V	
$Q_{rr}$	reverse recovery charge	$V_R = 600\text{ V}$ $di_F/dt = -600\text{ A}/\mu\text{s}$ $I_F = 30\text{ A}; V_{GE} = 0\text{ V}$	$T_{VJ} = 125^{\circ}\text{C}$	3.5		$\mu\text{C}$	
$I_{RM}$	max. reverse recovery current			30		A	
$t_{rr}$	reverse recovery time			350		ns	
$E_{rec}$	reverse recovery energy			0.9		mJ	
$R_{thJC}$	thermal resistance junction to case	(per diode)			0.4	1.2	K/W K/W
$R_{thCH}$	thermal resistance case to heatsink						

**Temperature Sensor NTC**

Symbol	Definitions	Conditions	Ratings			Unit
			min.	typ.	max.	
$R_{25}$	resistance	$T_C = 25^\circ\text{C}$	4.75	5.0	5.25	k $\Omega$
$B_{25/50}$				3375		K

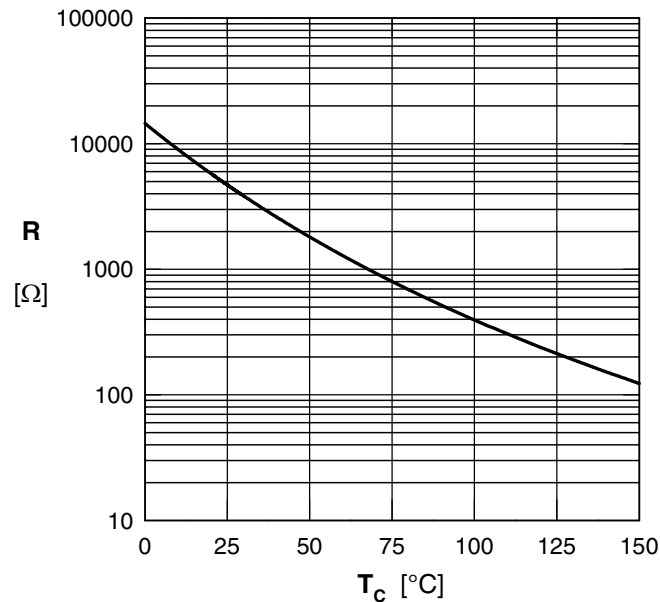

Typ. NTC resistance vs. temperature

**Module**

Symbol	Definitions	Conditions	Ratings			Unit
			min.	typ.	max.	
$T_{VJ}$	operating temperature		-40		125	$^\circ\text{C}$
$T_{VJM}$	max. virtual junction temperature				150	$^\circ\text{C}$
$T_{stg}$	storage temperature		-40		125	$^\circ\text{C}$
$V_{ISOL}$	isolation voltage	$I_{ISOL} \leq 1 \text{ mA}; 50/60 \text{ Hz}$			2500	V~
CTI	comparative tracking index				-	
$F_C$	mounting force		40		80	N
$d_s$	creep distance on surface		12.7			mm
$d_A$	strike distance through air		12.7			mm
Weight				40		g

### Circuit Diagram

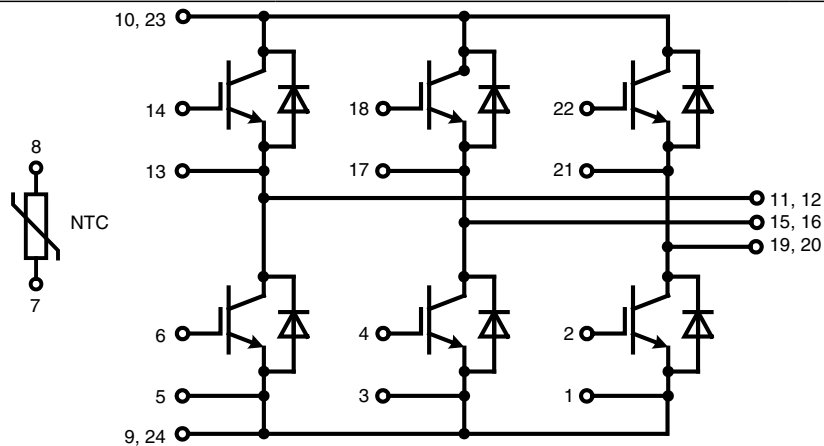

### Outline Drawing

Dimensions in mm (1 mm = 0.0394")

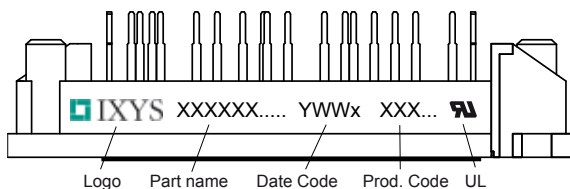
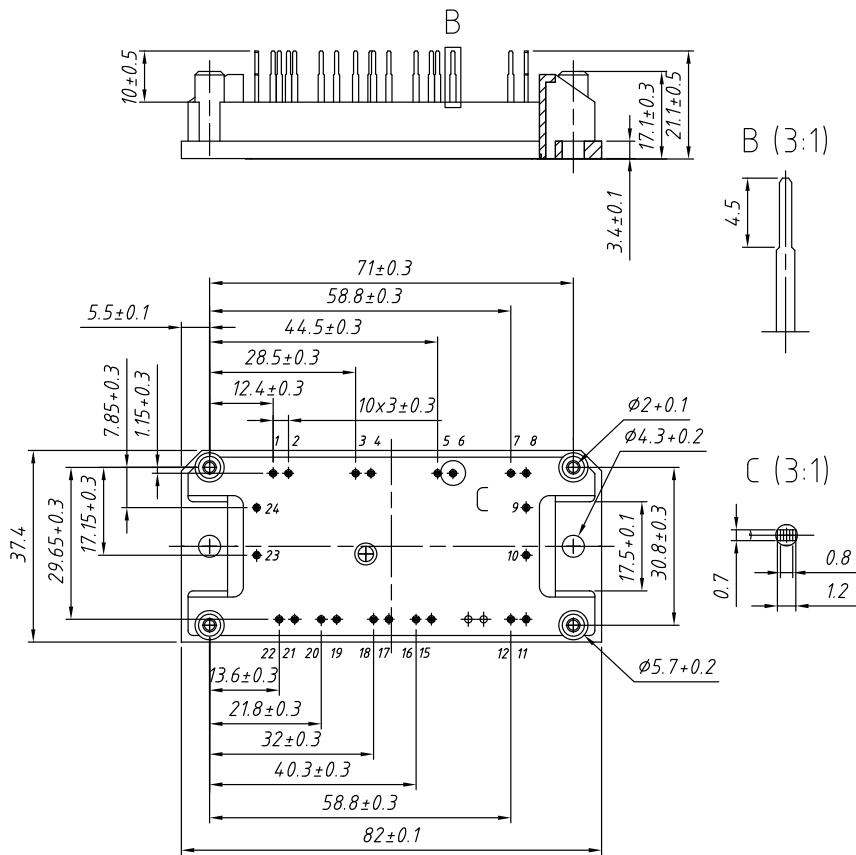

#### Part number

- M = Module
- I = IGBT
- X = XPT
- A = standard
- 40 = Current Rating [A]
- W = 6-Pack
- 1200 = Reverse Voltage [V]
- T = NTC
- ML = E1-Pack

Ordering	Part Name	Marking on Product	Delivering Mode	Base Qty	Ordering Code
Standard	MIXA 40 W 1200 TML	MIXA40W1200TML	Box	10	510628

## IGBT T1 - T6

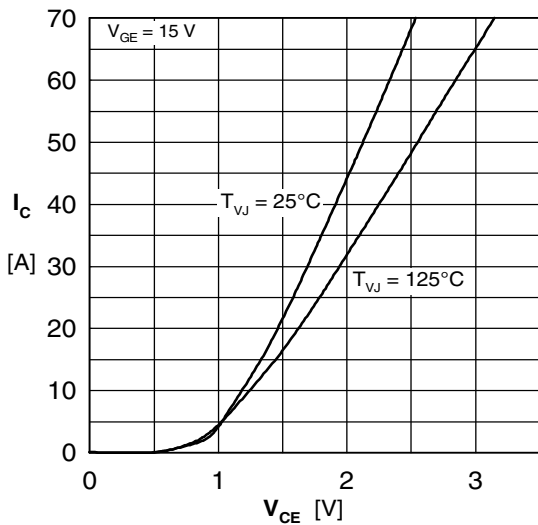

Fig. 1 Typ. output characteristics

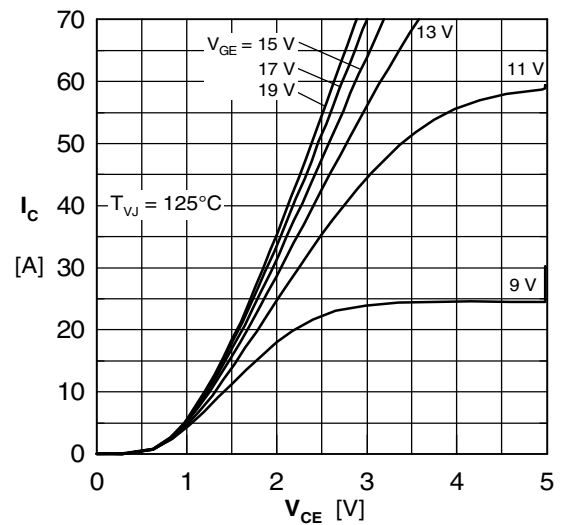

Fig. 2 Typ. output characteristics

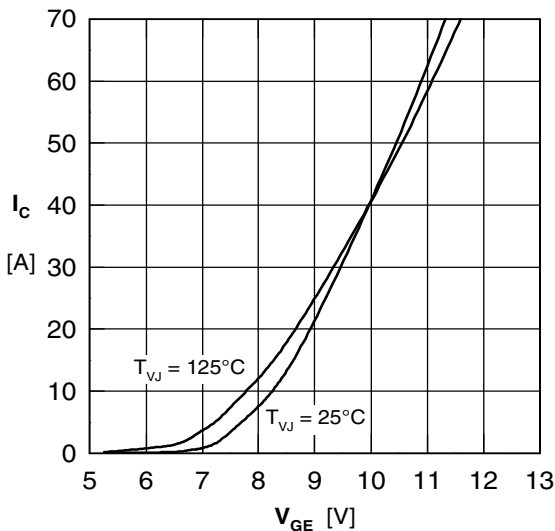

Fig. 3 Typ. transfer characteristics

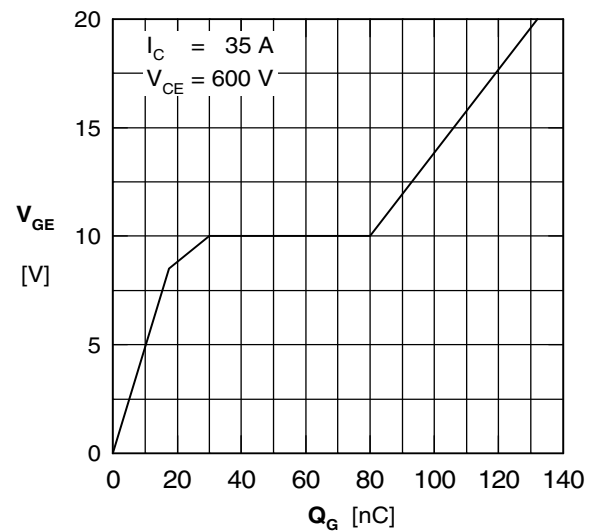

Fig. 4 Typ. turn-on gate charge

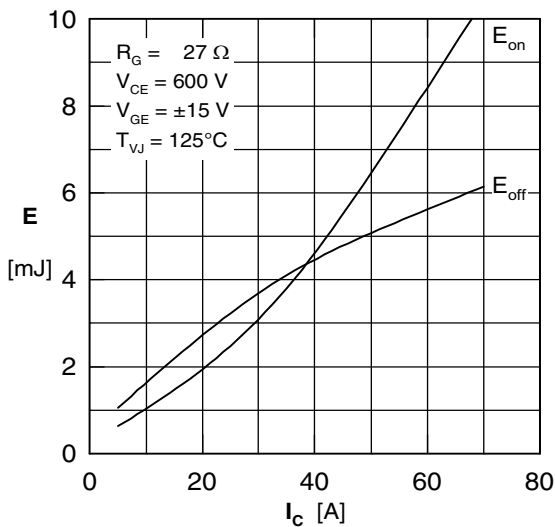

Fig. 5 Typ. switching energy vs. collector current

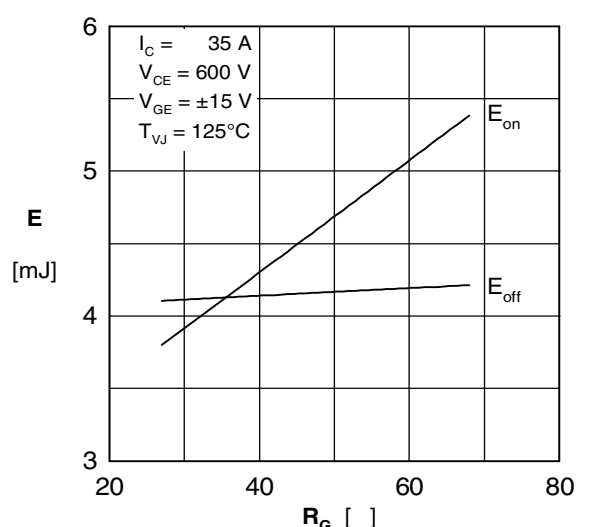

Fig. 6 Typ. switching energy vs. gate resistance

## Diode D1 - D6

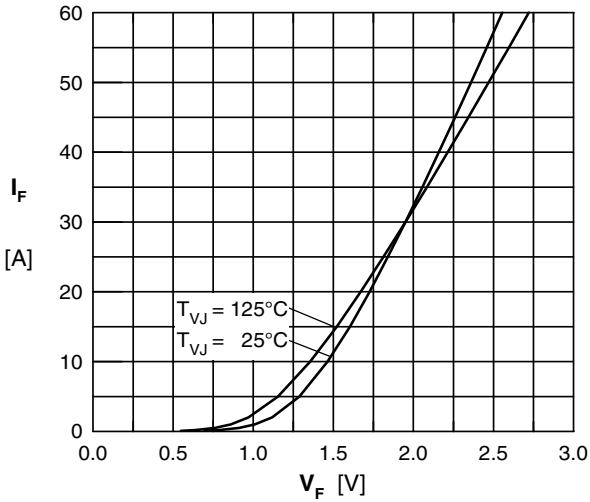

Fig. 7 Typ. Forward current versus  $V_F$

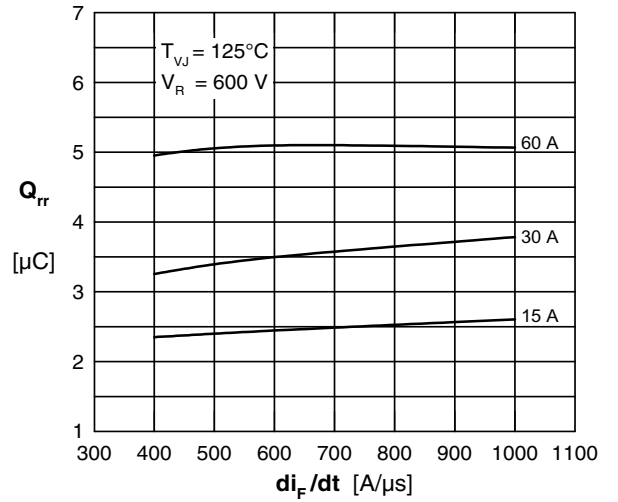

Fig. 8 Typ. reverse recov.charge  $Q_{rr}$  vs.  $di/dt$

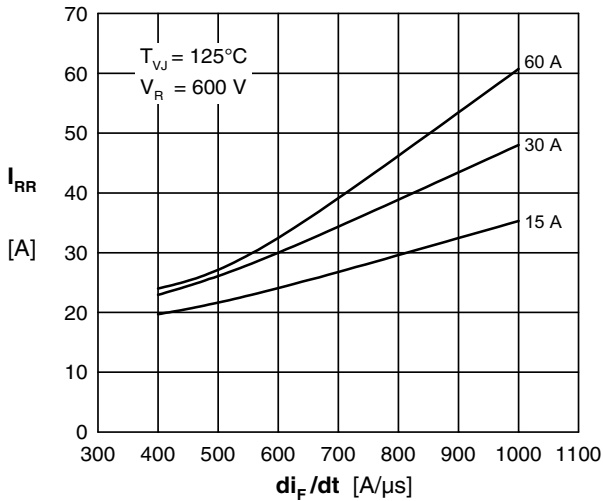

Fig. 9 Typ. peak reverse current  $I_{RM}$  vs.  $di/dt$

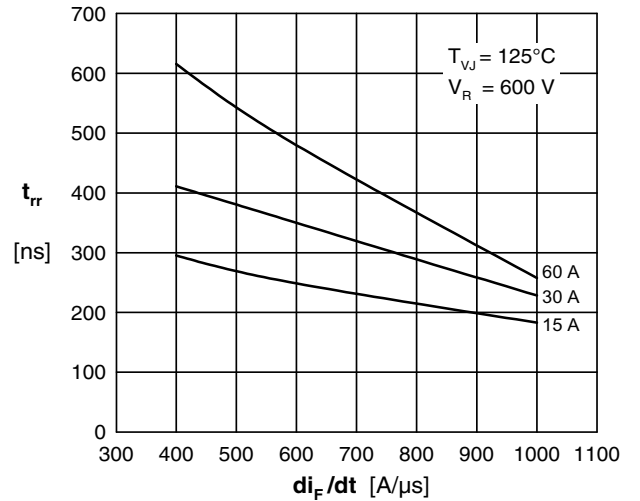

Fig. 10 Typ. recovery time  $t_{rr}$  versus  $di/dt$

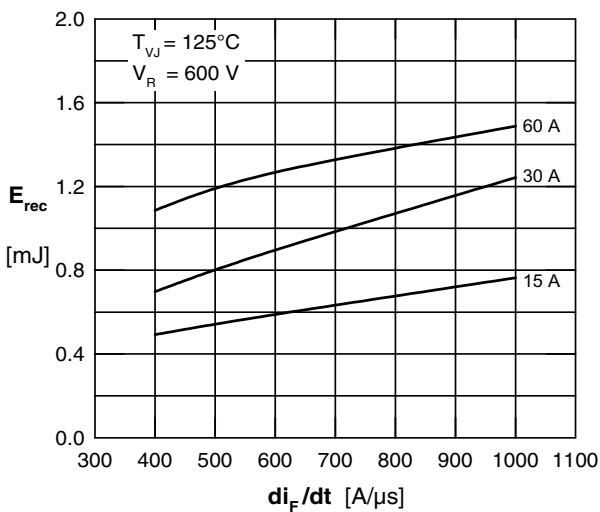

Fig. 11 Typ. recovery energy  $E_{rec}$  versus  $di/dt$

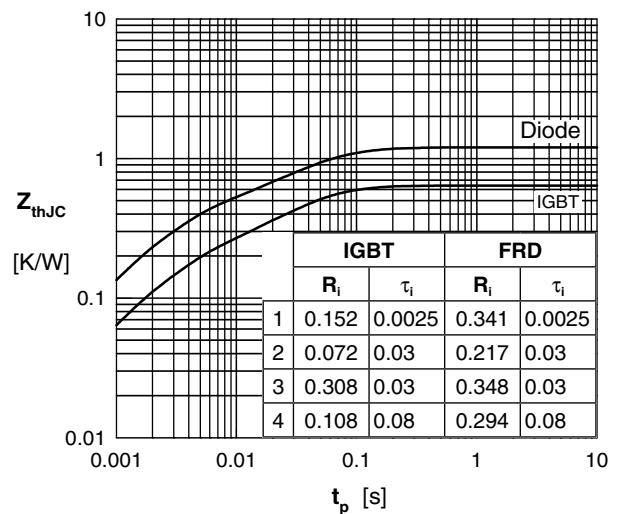

Fig. 12 Typ. transient thermal impedance