

N- And P-Channel Enhancement Mode Power MOSFET

MTC3588G6

	N-CH	P-CH
BV _{DSS}	14V	-14V
I _D @ T _A =25 °C	5.4A(V _{GS} =4.5V)	-3.6A(V _{GS} =-4.5 V)
R _{DSON} (TYP.)	17.6mΩ(V _{GS} =4.5V)	45.1mΩ(V _{GS} =-4.5V)
	24.7mΩ(V _{GS} =2.5V)	65.6mΩ(V _{GS} =-2.5V)
	39.5mΩ(V _{GS} =1.8V)	88.5mΩ(V _{GS} =-1.8V)
	67.3mΩ(V _{GS} =1.5V)	154.3mΩ(V _{GS} =-1.5V)

Features

- Simple drive requirement
- Low gate charge
- Low on-resistance
- Fast switching speed
- Pb-free lead plating and halogen-free package

Equivalent Circuit

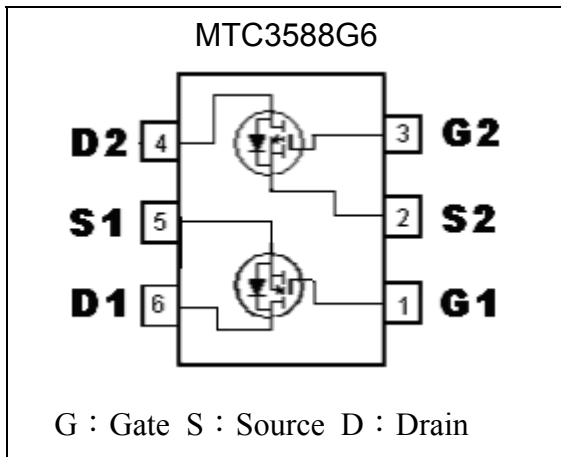

Outline

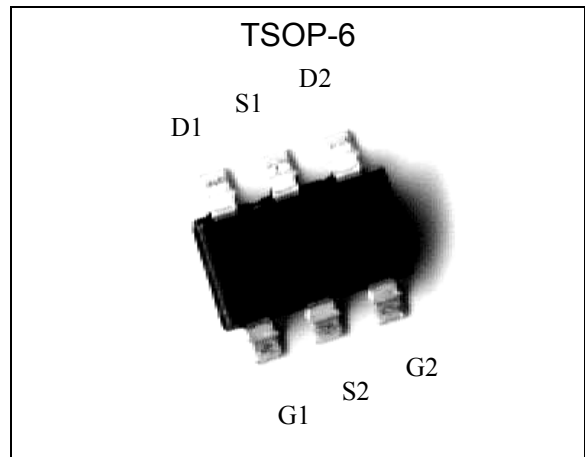

Ordering Information

Device	Package	Shipping
MTC3588G6-0-T1-G	TSOP-6 (Pb-free lead plating and halogen-free package)	3000 pcs / Tape & Reel

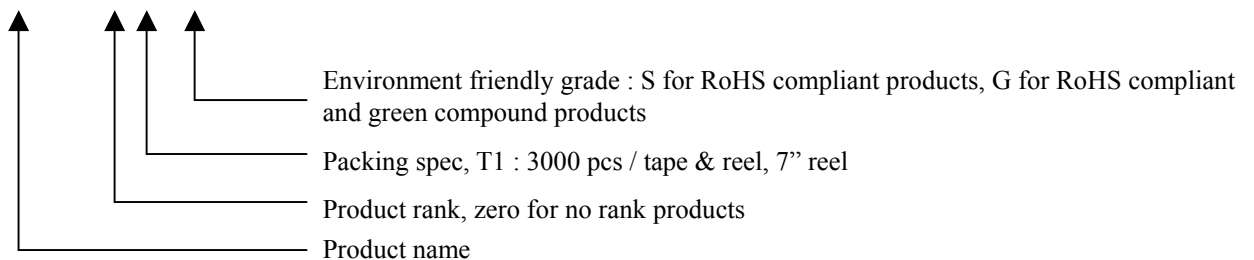



Absolute Maximum Ratings (Ta=25°C)

Parameter	Symbol	Limits		Unit
		N-channel	P-channel	
Drain-Source Breakdown Voltage	BV _{DSS}	14	-14	V
Gate-Source Voltage	V _{GS}	±8	±8	
Continuous Drain Current @T _A =25 °C (Note 1)	I _D	5.4	-3.6	A
Continuous Drain Current @T _A =70 °C (Note 1)		4.3	-2.9	
Pulsed Drain Current (Note 2)	I _{DM}	20	-20	
Total Power Dissipation (Note 1)	P _D	1.14		W
Linear Derating Factor		0.01		W / °C
Operating Junction and Storage Temperature	T _j , T _{stg}	-55~+150		°C

Note : 1.Surface mounted on 1 in² copper pad of FR-4 board, t≤5 sec.
 2.Pulse width limited by maximum junction temperature.

N-Channel Electrical Characteristics (Tj=25°C, unless otherwise specified)

Symbol	Min.	Typ.	Max.	Unit	Test Conditions
Static					
BV _{DSS}	14	-	-	V	V _{GS} =0V, I _D =250μA
ΔBV _{DSS} /ΔT _j	-	8	-	mV/°C	Reference to 25°C, I _D =1mA
V _{GS(th)}	0.4	-	1.0	V	V _{DS} =V _{GS} , I _D =250μA
I _{GS}	-	-	±100	nA	V _{GS} =±8V, V _{DS} =0V
I _{DSS}	-	-	1	μA	V _{DS} =12V, V _{GS} =0V
	-	-	10		V _{DS} =10V, V _{GS} =0V, T _j =70°C
*R _{DS(ON)}	-	17.6	25	mΩ	I _D =5A, V _{GS} =4.5V
	-	24.7	33		I _D =4.6A, V _{GS} =2.5V
	-	39.5	75		I _D =4.1A, V _{GS} =1.8V
	-	67.3	115		I _D =2A, V _{GS} =1.5V
*G _{FS}	-	5.6	-	S	V _{DS} =5V, I _D =3A
Dynamic					
C _{iss}	-	407	-	pF	V _{DS} =10V, V _{GS} =0V, f=1MHz
C _{oss}	-	115	-		
C _{rss}	-	100	-		
*t _{d(ON)}	-	5	-	ns	V _{DS} =10V, I _D =1A, V _{GS} =5V, R _G =3.3Ω
*t _r	-	18.8	-		
*t _{d(OFF)}	-	49.6	-		
*t _f	-	30.8	-		
*Q _g	-	6.5	-	nC	V _{DS} =10V, I _D =3A, V _{GS} =4.5V
*Q _{gs}	-	0.7	-		
*Q _{gd}	-	2.3	-		
R _g	-	1	-	Ω	f=1MHz
Source-Drain Diode					
*V _{SD}	-	0.87	1.2	V	V _{GS} =0V, I _S =5.2A
*t _{rr}	-	12	-	ns	I _F =3A, V _{GS} =0V, dI _F /dt=100A/μs
*Q _{rr}	-	2.3	-	nC	



*Pulse Test : Pulse Width ≤300μs, Duty Cycle≤2%

P-Channel Electrical Characteristics (Tj=25°C, unless otherwise specified)

Symbol	Min.	Typ.	Max.	Unit	Test Conditions
Static					
BV _{DSS}	-14	-	-	V	V _{GS} =0V, I _D =-250μA
ΔBV _{DSS} /ΔT _j	-	-5	-	mV/°C	Reference to 25°C, I _D =-1mA
V _{GS(th)}	-0.4	-	-1.0	V	V _{DS} =V _{GS} , I _D =-250μA
I _{GSS}	-	-	±100	nA	V _{GS} =±8V, V _{DS} =0V
I _{DSS}	-	-	-1	μA	V _{DS} =-12V, V _{GS} =0V
	-	-	-10		V _{DS} =-10V, V _{GS} =0, T _j =70°C
*R _{DS(ON)}	-	45.1	60	mΩ	I _D =-3.6A, V _{GS} =-4.5V
	-	65.6	87		I _D =-3.2A, V _{GS} =-2.5V
	-	88.5	178		I _D =-1A, V _{GS} =-1.8V
	-	154.3	305		I _D =-1A, V _{GS} =-1.5V
*G _{FS}	-	5.6	-	S	V _{DS} =-5V, I _D =-2A
Dynamic					
C _{iss}	-	561	-	pF	V _{DS} =-10V, V _{GS} =0V, f=1MHz
C _{oss}	-	153	-		
C _{rss}	-	142	-		
*t _{d(ON)}	-	5	-	ns	V _{DS} =-10V, I _D =-1A, V _{GS} =-5V, R _G =3.3Ω
*t _r	-	18.8	-		
*t _{d(OFF)}	-	49.6	-		
*t _f	-	30.8	-		
*Q _g	-	8	-	nC	V _{DS} =-10V, I _D =-2A, V _{GS} =-4.5V
*Q _{gs}	-	1	-		
*Q _{gd}	-	2.8	-		
R _g	-	9.3	-	Ω	f=1MHz
Source-Drain Diode					
*V _{SD}	-	-0.9	-1.2	V	V _{GS} =0V, I _S =-3.4A
*t _{rr}	-	27	-	ns	I _F =-2A, V _{GS} =0V, dI _F /dt=100A/μs
*Q _{rr}	-	7	-	nC	

*Pulse Test : Pulse Width ≤300μs, Duty Cycle≤2%

Thermal Data

Parameter	Symbol	Value	Unit
Thermal Resistance, Junction-to-case, max	R _{θJC}	80	°C/W
Thermal Resistance, Junction-to-ambient, max	R _{θJA}	110 (Note)	

Note : Surface mounted on 1 in² copper pad of FR-4 board, t≤5 sec; 180°C/W when mounted on minimum copper pad



N-channel Typical Characteristics

Typical Output Characteristics

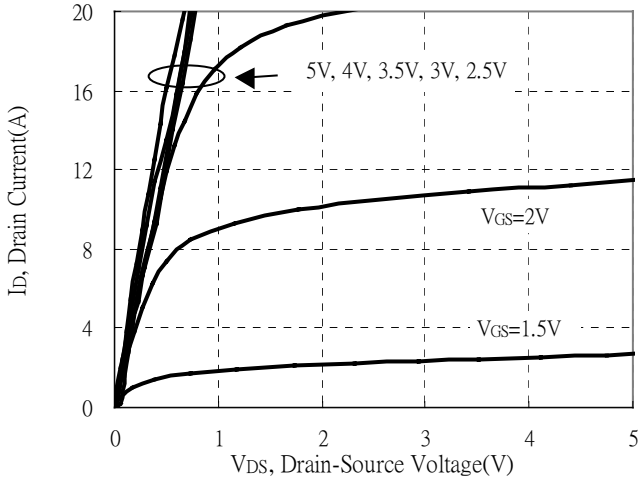

Brekdown Voltage vs Ambient Temperature

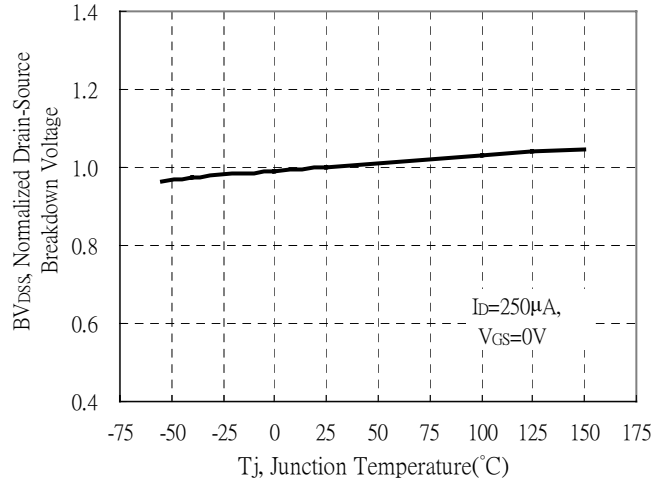

Static Drain-Source On-State resistance vs Drain Current

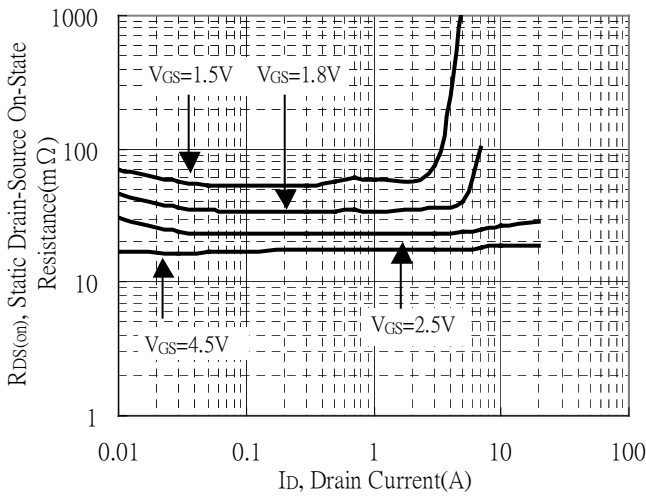

Reverse Drain Current vs Source-Drain Voltage

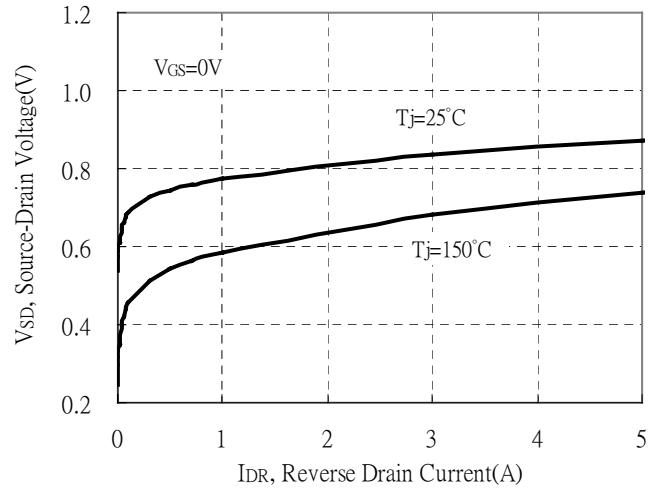

Static Drain-Source On-State Resistance vs Gate-Source Voltage

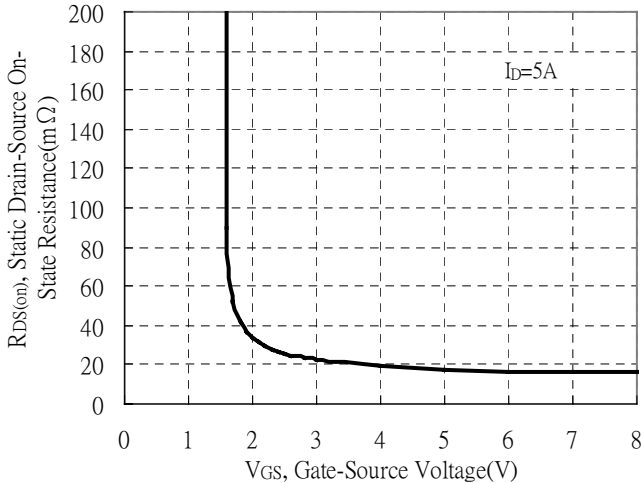

Drain-Source On-State Resistance vs Junction Temperature

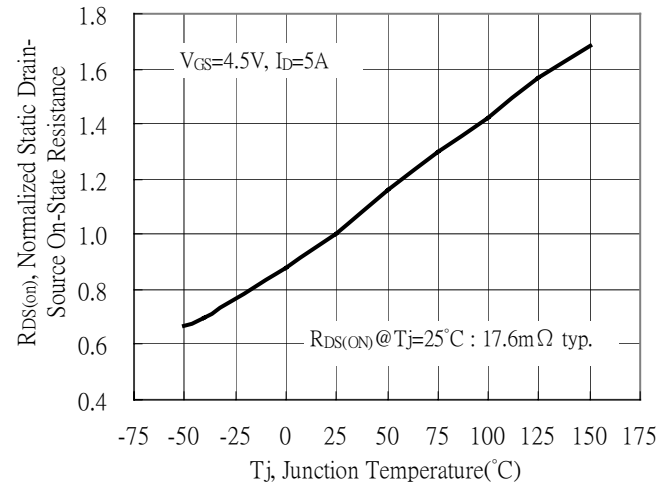



N-channel Typical Characteristics(Cont.)

Capacitance vs Drain-to-Source Voltage

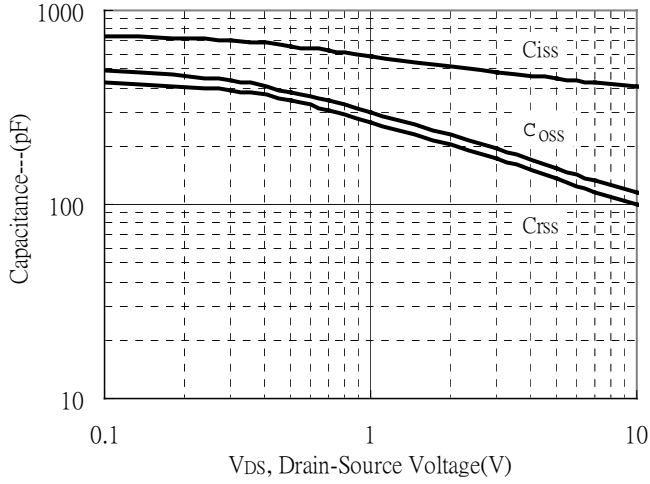

Threshold Voltage vs Junction Temperature

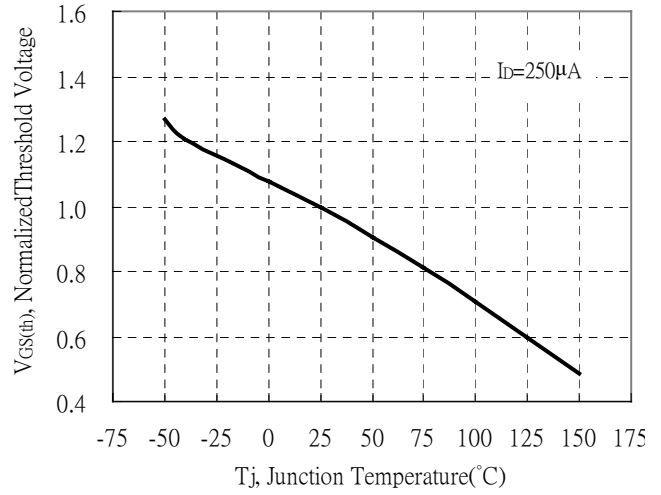

Single Pulse Power Rating, Junction to Ambient

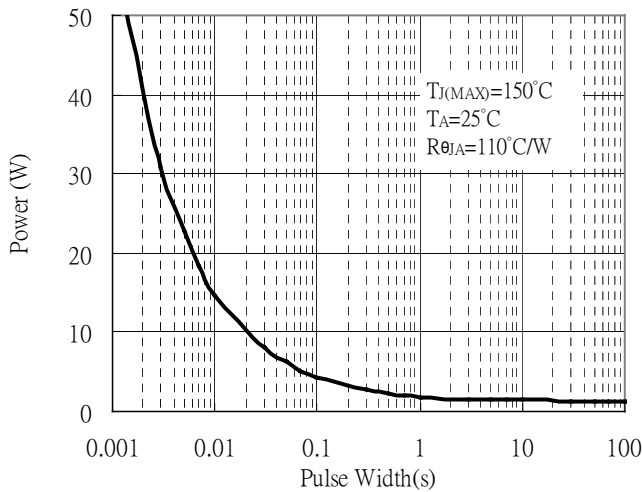

Gate Charge Characteristics

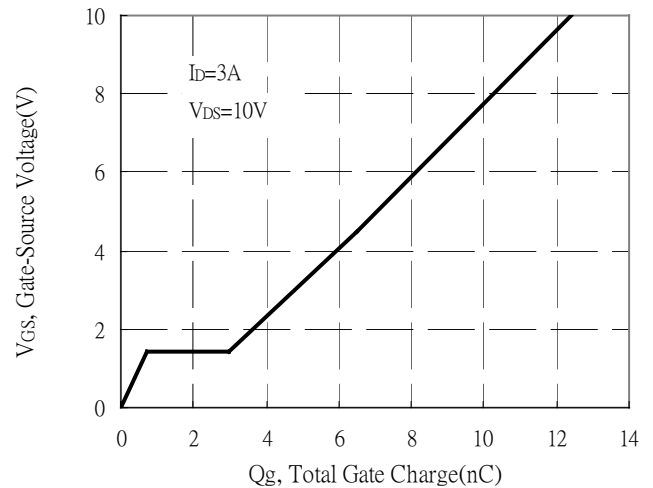

Maximum Safe Operating Area

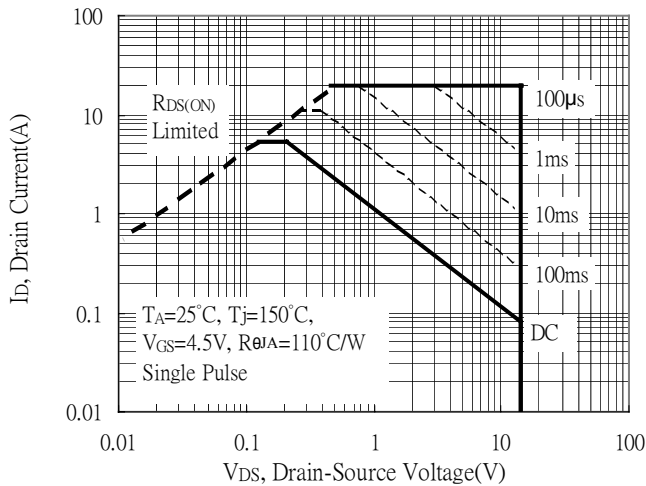

Maximum Drain Current vs Junction Temperature

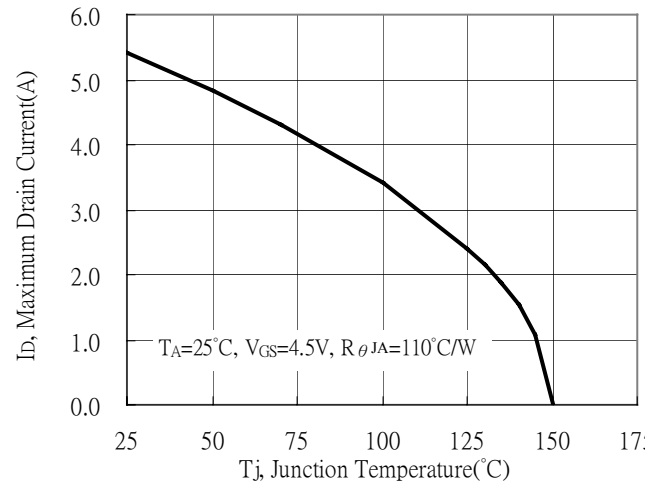

N-channel Typical Characteristics(Cont.)

Typical Transfer Characteristics

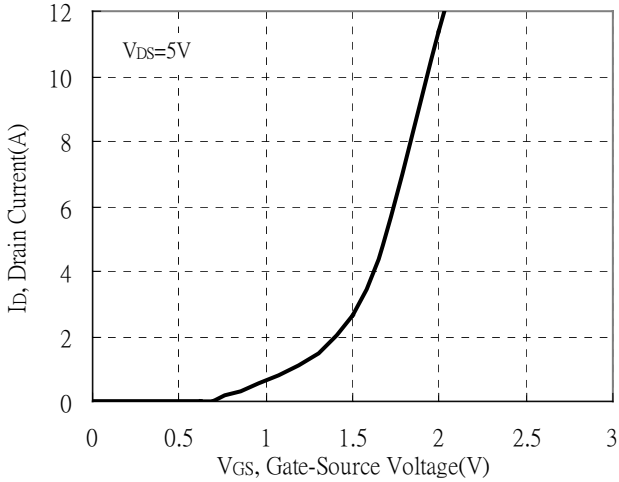

Forward Transfer Admittance vs Drain Current

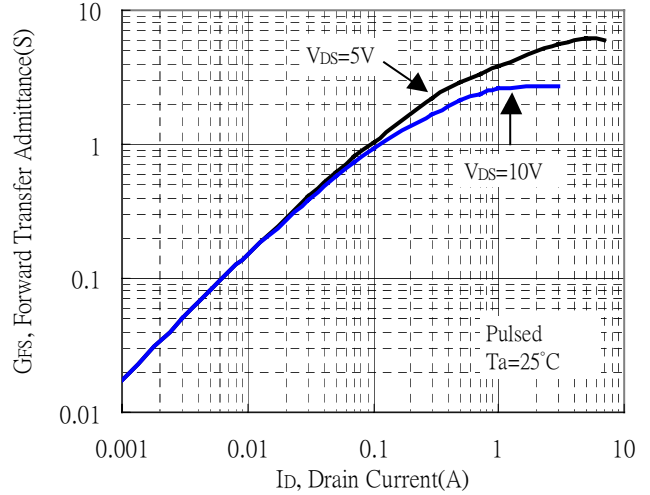

Transient Thermal Response Curves

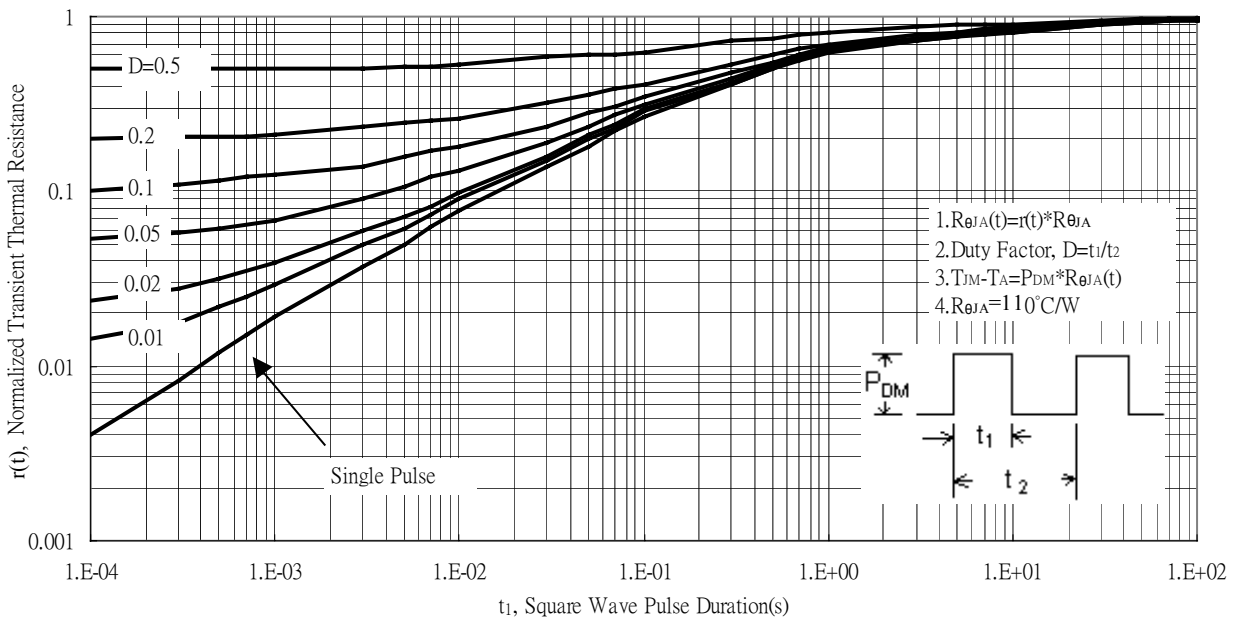



P-channel Typical Characteristics

Typical Output Characteristics

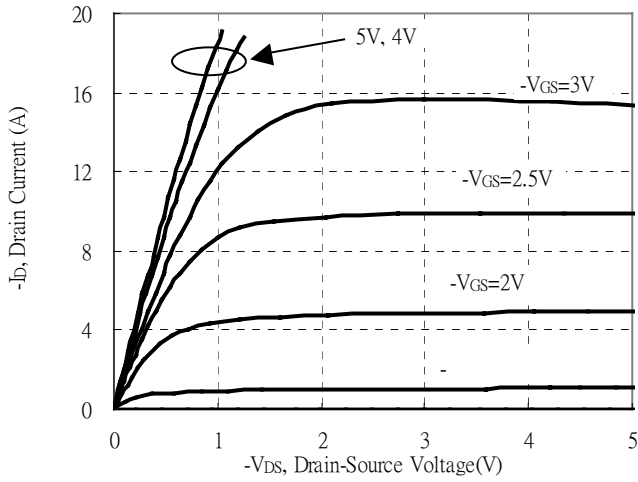

Breakdown Voltage vs Ambient Temperature

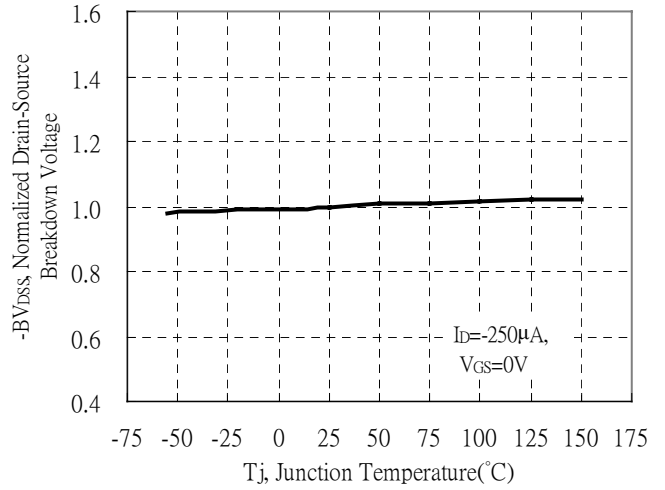

Static Drain-Source On-State resistance vs Drain Current

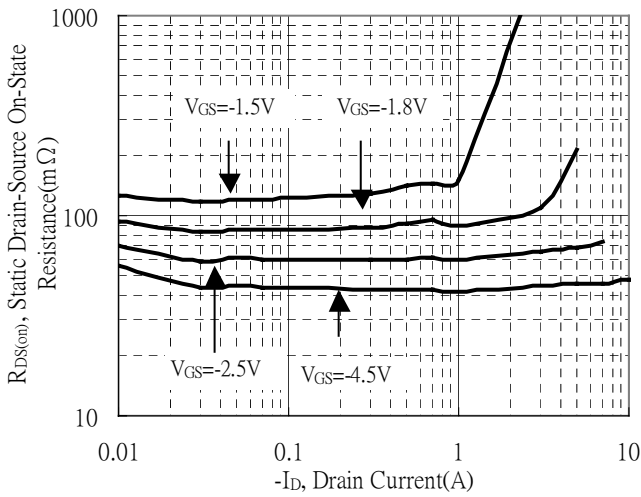

Reverse Drain Current vs Source-Drain Voltage

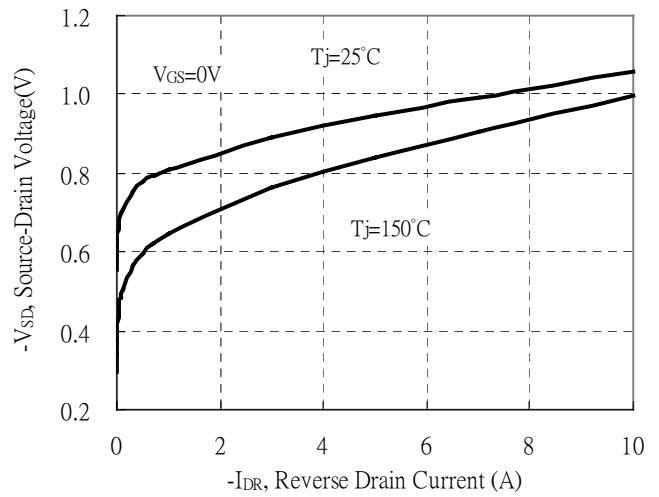

Static Drain-Source On-State Resistance vs Gate-Source Voltage

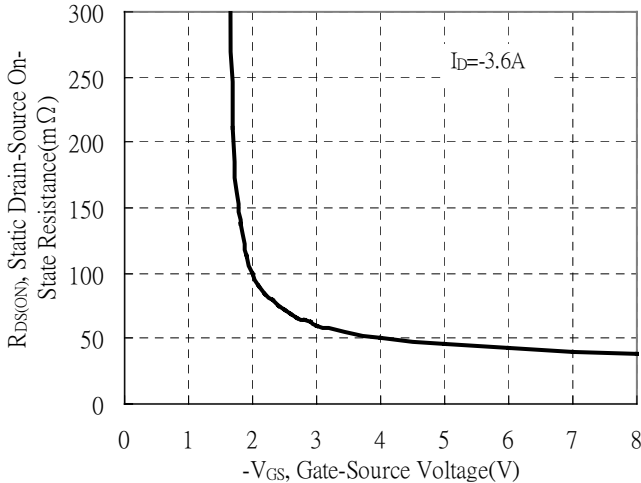

Drain-Source On-State Resistance vs Junction Temperature

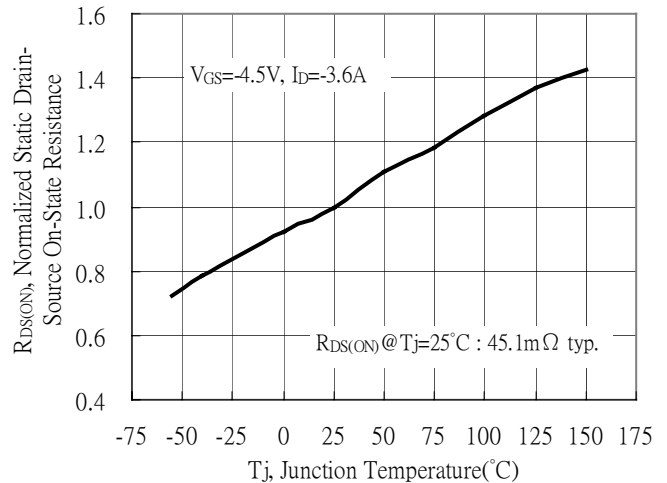

P-channel Typical Characteristics(Cont.)

Capacitance vs Drain-to-Source Voltage

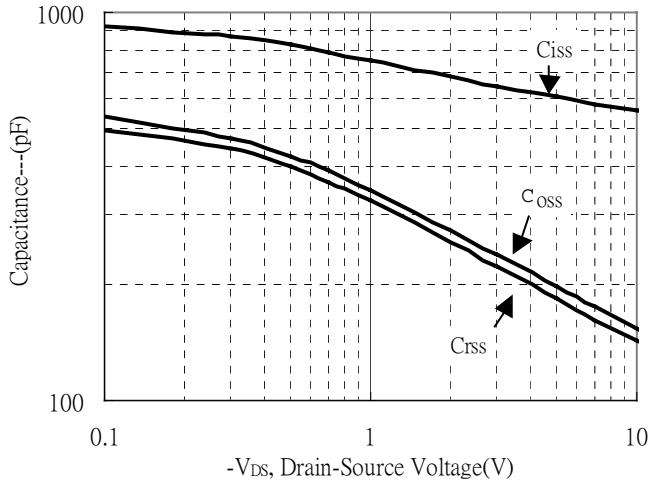

Threshold Voltage vs Junction Temperature

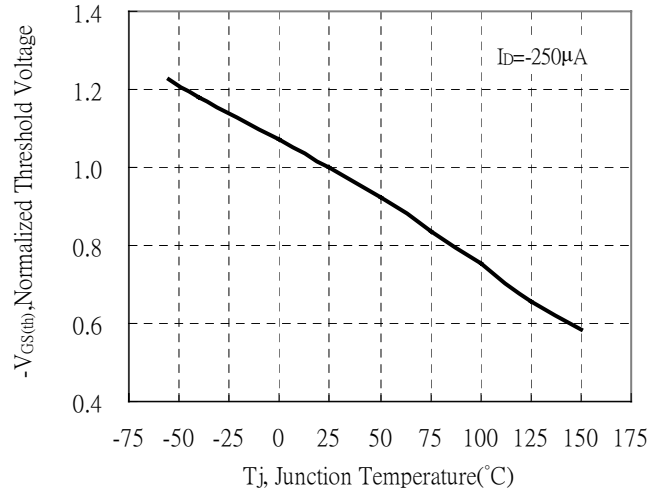

Single Pulse Power Rating, Junction to Ambient

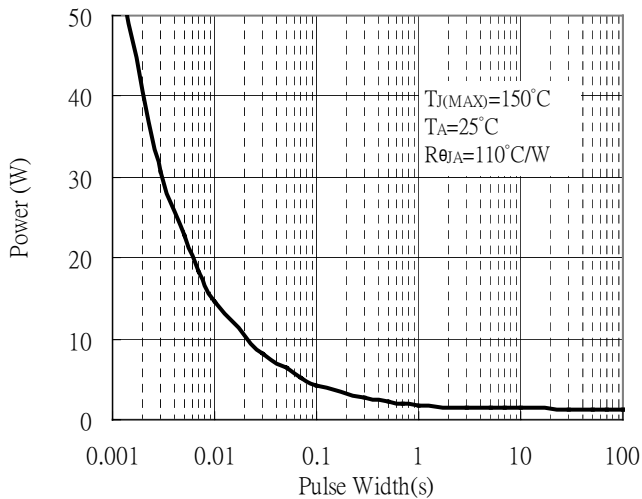

Gate Charge Characteristics

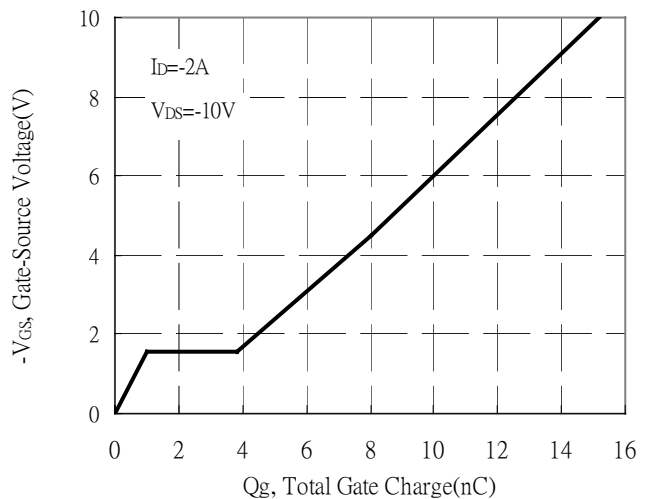

Maximum Safe Operating Area

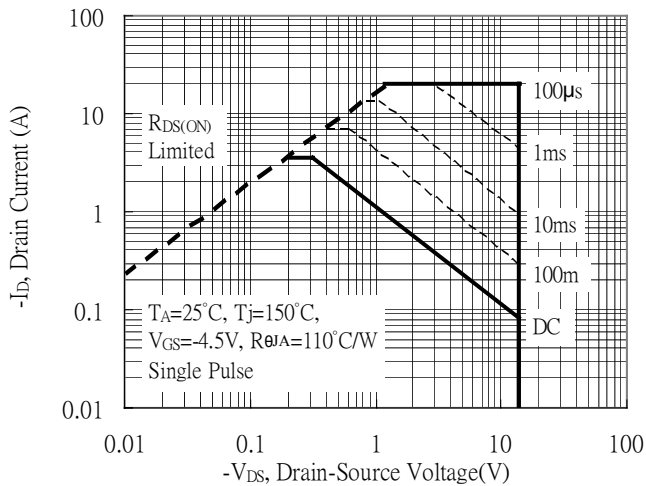

Maximum Drain Current vs Junction Temperature

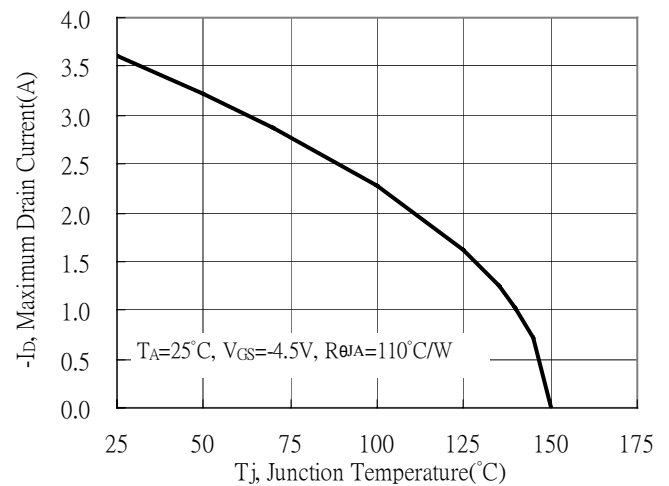

P-channel Typical Characteristics(Cont.)

Typical Transfer Characteristics

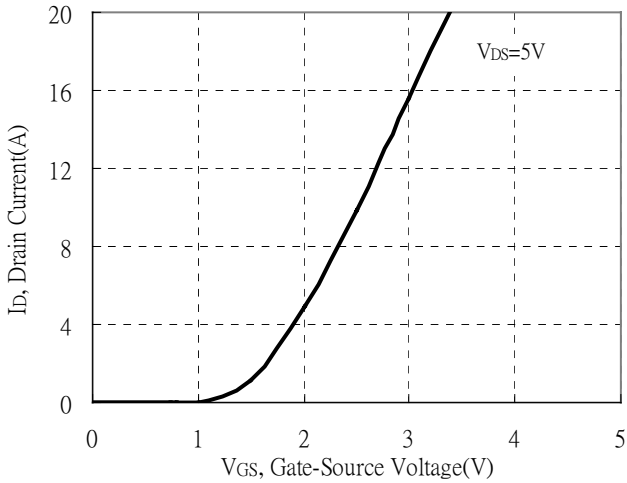

Forward Transfer Admittance vs Drain Current

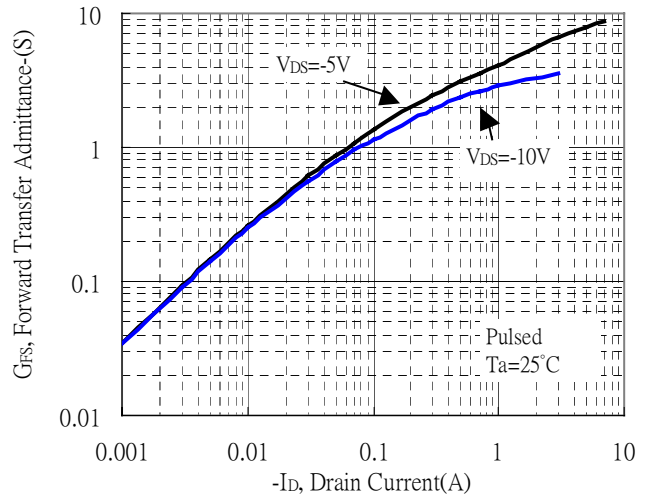

Transient Thermal Response Curves

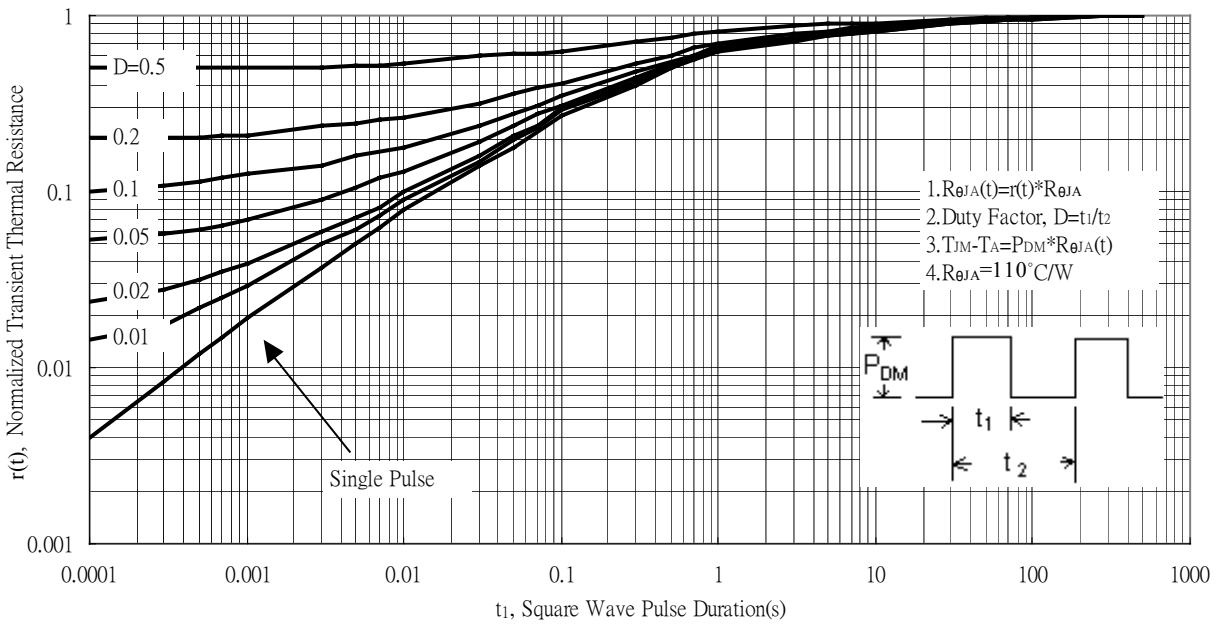

Recommended Soldering Footprint

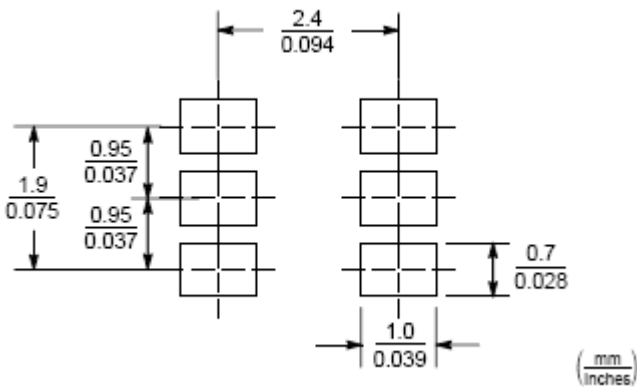

Reel Dimension

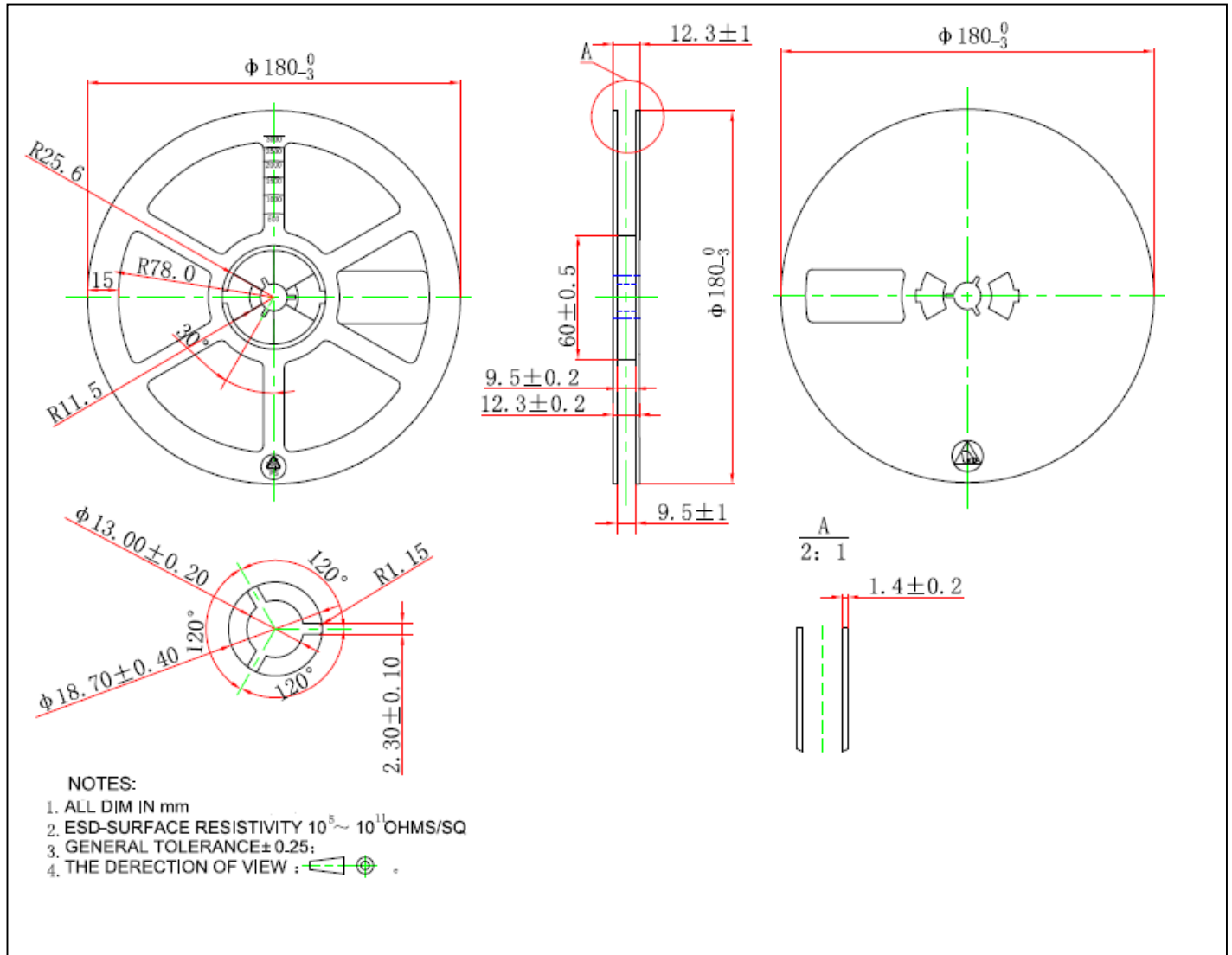

Carrier Tape Dimension

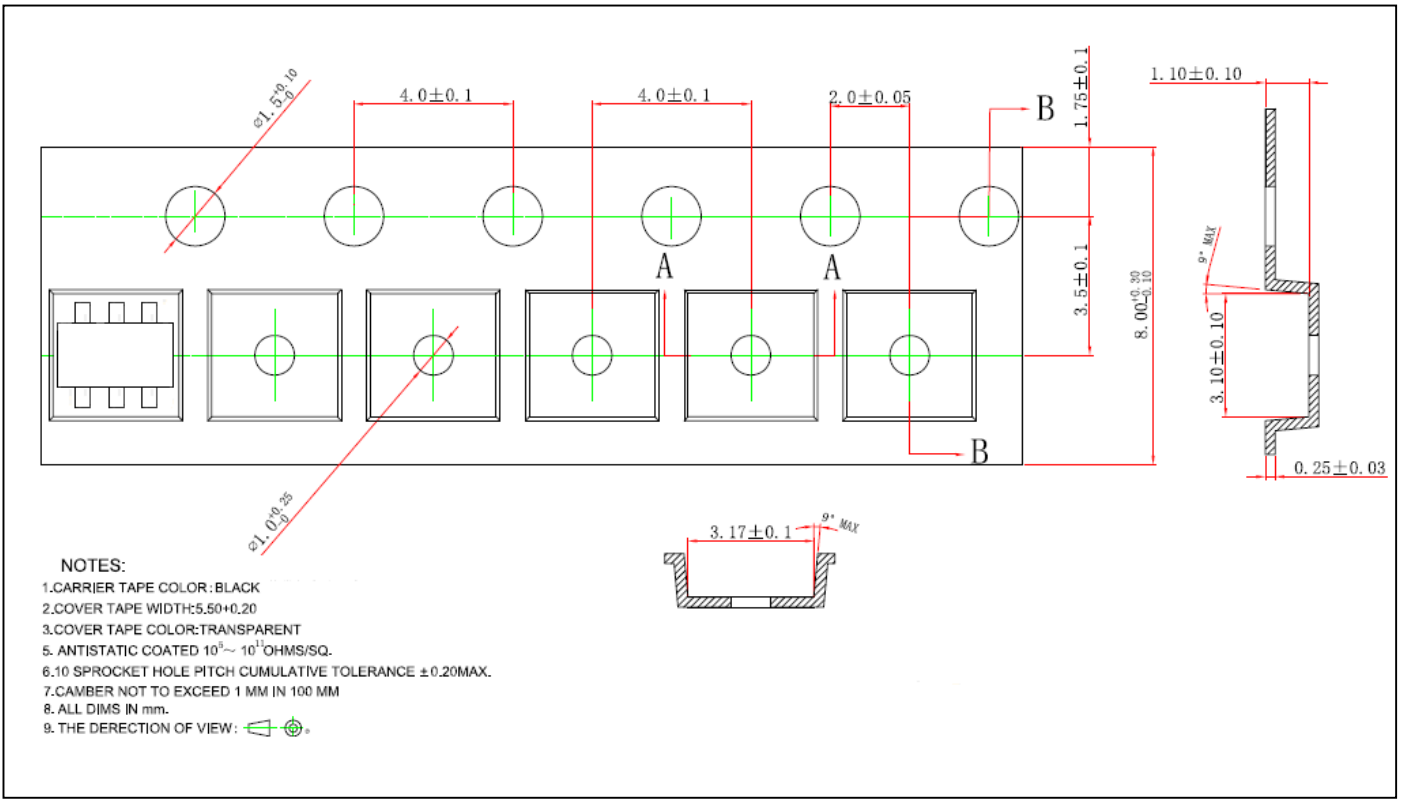

Recommended wave soldering condition

Product	Peak Temperature	Soldering Time
Pb-free devices	260 +0/-5 °C	5 +1/-1 seconds

Recommended temperature profile for IR reflow

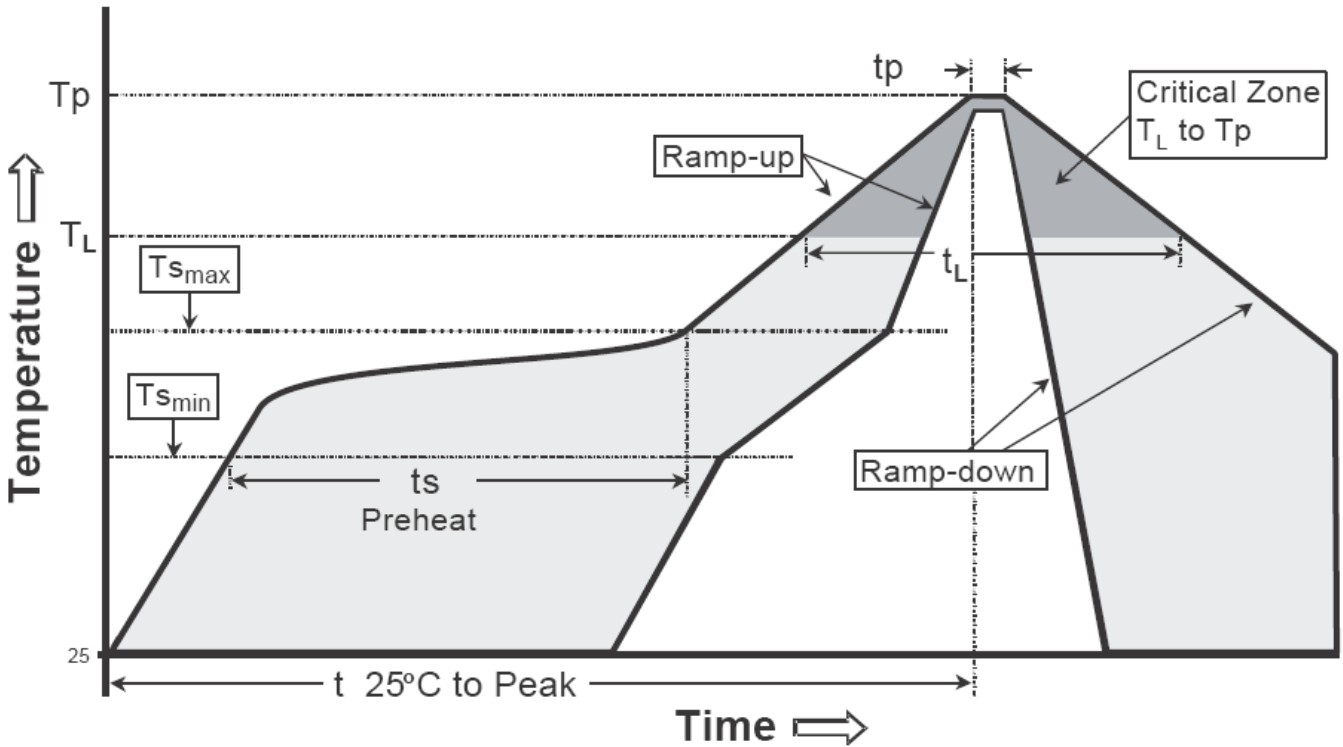

Profile feature	Sn-Pb eutectic Assembly	Pb-free Assembly
Average ramp-up rate (T _{smax} to T _p)	3°C/second max.	3°C/second max.
Preheat		
-Temperature Min(T _{s min})	100°C	150°C
-Temperature Max(T _{s max})	150°C	200°C
-Time(t _{s min} to t _{s max})	60-120 seconds	60-180 seconds
Time maintained above:		
-Temperature (T _L)	183°C	217°C
- Time (t _L)	60-150 seconds	60-150 seconds
Peak Temperature(T _P)	240 +0/-5 °C	260 +0/-5 °C
Time within 5°C of actual peak temperature(t _p)	10-30 seconds	20-40 seconds
Ramp down rate	6°C/second max.	6°C/second max.
Time 25 °C to peak temperature	6 minutes max.	8 minutes max.

Note : All temperatures refer to topside of the package, measured on the package body surface.

TSOP-6 Dimension

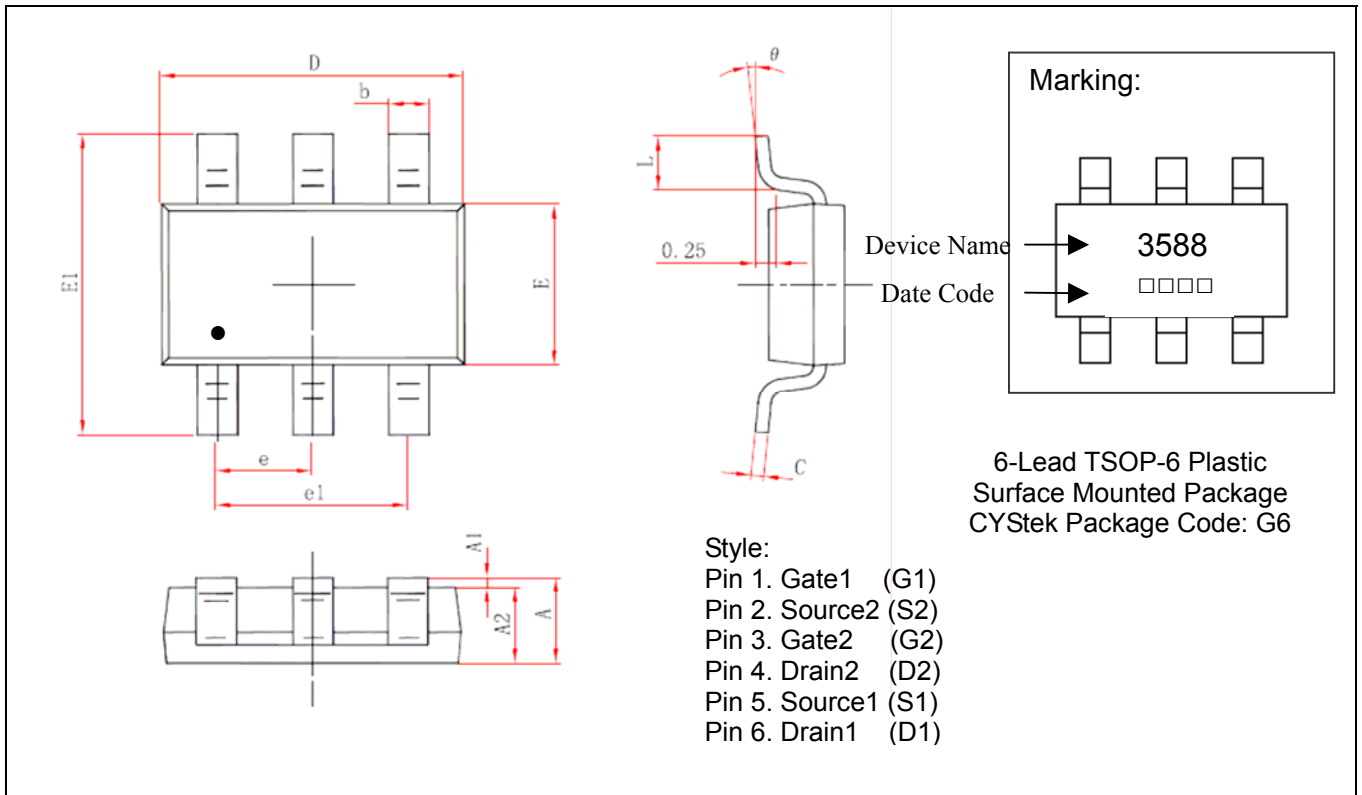

DIM	Millimeters		Inches		DIM	Millimeters		Inches	
	Min.	Max.	Min.	Max.		Min.	Max.	Min.	Max.
A	0.700	0.900	0.028	0.035	E	1.600	1.700	0.063	0.067
A1	0.000	0.100	0.000	0.004	E1	2.650	2.950	0.104	0.116
A2	0.700	0.800	0.028	0.031	e	0.950 (BSC)		0.037 (BSC)	
b	0.350	0.500	0.014	0.020	e1	1.900 (BSC)		0.075 (BSC)	
c	0.080	0.200	0.003	0.008	L	0.300	0.600	0.012	0.024
D	2.820	3.020	0.111	0.119	θ	0°	8°	0°	8°

Notes : 1.Controlling dimension : millimeters.
 2.Maximum lead thickness includes lead finish thickness, and minimum lead thickness is the minimum thickness of base material.
 3.If there is any question with packing specification or packing method, please contact your local CYStek sales office.

Material :

- Lead :Pure tin plated.
- Mold Compound : Epoxy resin family, flammability solid burning class:UL94V-0.

Important Notice:

- All rights are reserved. Reproduction in whole or in part is prohibited without the prior written approval of CYStek.
- CYStek reserves the right to make changes to its products without notice.
- CYStek **semiconductor products are not warranted to be suitable for use in Life-Support Applications, or systems.**
- CYStek assumes no liability for any consequence of customer product design, infringement of patents, or application assistance.