



Features

- Low Cost
- Broadband Gain
- Internally Matched
- Internal Active Bias
- No Dropping Resistor
- Single Supply 5V Operation
- HBM ESD Level >1000V

Applications

- PA Driver Amplifier
- LO Buffer Amplifier
- Cellular, PCS, GSM, UMTS, LTE, TD-SCDMA
- Wideband Instrumentation
- Wireless Data, Satellite Terminals

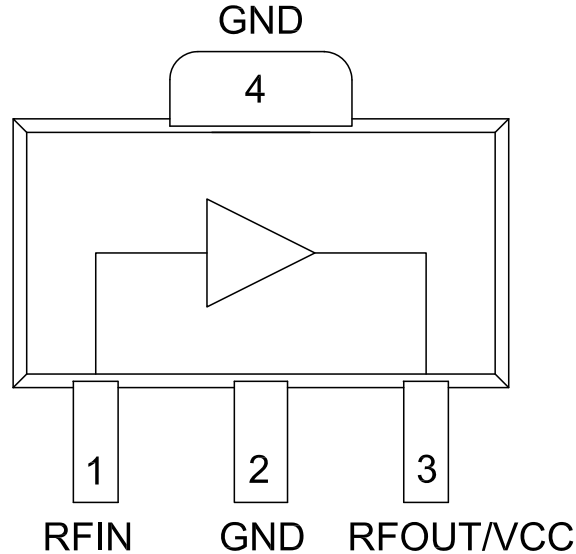

Functional Block Diagram

Product Description

The RFGA2044 is a high performance InGaP HBT MMIC amplifier. The RFGA2044's internal active bias circuitry allows the amplifier to operate directly from a 5V supply and provides stable current over temperature and process Beta variation. This Darlington amplifier is internally matched to 50Ω making it ideal for applications requiring small footprints and minimal external components.

Ordering Information

RFGA2044SR	7" Sample reel with 100 pieces
RFGA2044SQ	Sample bag with 25 pieces
RFGA2044TR7	7" Reel with 750 pieces
RFGA2044TR13	13" Reel with 2500 pieces
RFGA2044PCK-410	500MHz to 3000MHz PCBA with 5-piece sample bag

Optimum Technology Matching® Applied

- | | | | |
|---|--------------------------------------|-------------------------------------|------------------------------------|
| <input type="checkbox"/> GaAs HBT | <input type="checkbox"/> SiGe BiCMOS | <input type="checkbox"/> GaAs pHEMT | <input type="checkbox"/> GaN HEMT |
| <input type="checkbox"/> GaAs MESFET | <input type="checkbox"/> Si BiCMOS | <input type="checkbox"/> Si CMOS | <input type="checkbox"/> BiFET HBT |
| <input checked="" type="checkbox"/> InGaP HBT | <input type="checkbox"/> SiGe HBT | <input type="checkbox"/> Si BJT | <input type="checkbox"/> LDMOS |

Absolute Maximum Ratings

Parameter	Rating	Unit
Supply Voltage (V_{CC})	6.0	V
Device Current (I_{CC})	130	mA
CW Input Power, 2:1 Output VSWR	20	dBm
CW Input Power, 10:1 Output VSWR	15	dBm
Operating Junction Temperature (T_J)	150	°C
Operating Temperature Range (T_L)	-40 to +85	°C
Storage Temperature	-55 to +150	°C
ESD Rating - Human Body Model	1C (1000V)	
Moisture Sensitivity Level	MSL-2	



Caution! ESD sensitive device.

Exceeding any one or a combination of the Absolute Maximum Rating conditions may cause permanent damage to the device. Extended application of Absolute Maximum Rating conditions to the device may reduce device reliability. Specified typical performance or functional operation of the device under Absolute Maximum Rating conditions is not implied.

The information in this publication is believed to be accurate and reliable. However, no responsibility is assumed by RF Micro Devices, Inc. ("RFMD") for its use, nor for any infringement of patents, or other rights of third parties, resulting from its use. No license is granted by implication or otherwise under any patent or patent rights of RFMD. RFMD reserves the right to change component circuitry, recommended application circuitry and specifications at any time without prior notice.



RFMD Green: RoHS compliant per EU Directive 2002/95/EC, halogen free per IEC 61249-2-21, < 1000ppm each of antimony trioxide in polymeric materials and red phosphorus as a flame retardant, and <2% antimony in solder.

NOTES: 1. The maximum rating must all be met simultaneously.

2. $P_{DISS} = P_{DC} + P_{RFIN} - P_{RFOUT}$.

3. $T_J = T_L + P_{DISS} * R_{TH}$.

Parameter	Specification			Unit	Condition
	Min.	Typ.	Max.		
Linear Operation					Typical performance at 25 °C using the standard sample EVB with R2 = open. This design is for linear operation only.
Input Power (P_{IN})			6.0	dBm	Max recommended continuous input power, $V_{CC} < 5.0V$, Load VSWR < 2:1
Gain		15.3		dB	850MHz
	13.5	15.1	16.5	dB	2140MHz
		15.1		dB	2650MHz
OIP3		35.5		dBm	850MHz (0dBm/Tone, 1MHz spacing)
	28	30.5		dBm	2140MHz (0dBm/Tone, 1MHz spacing)
		29.0		dBm	2650MHz (0dBm/Tone, 1MHz spacing)
P1dB		19.0		dBm	850MHz
	17.3	18.8		dBm	2140MHz
		18.2		dBm	2650MHz
Input Return Loss		15		dB	2140MHz
Output Return Loss		14		dB	
Isolation		19		dB	
Noise Figure		4.3		dB	
Operating Current (Quiescent)		68	78	mA	
Operating Voltage (V_{CC})		5.0	5.25	V	Max recommended voltage for continuous operation
Thermal Resistance (R_{TH})		135		°C/W	At quiescent current, no RF, $V_{CC} = 5.0V$
Saturated Operation					Typical performance at 25 °C using the input pull-down resistor (R2 = 5.1 K Ω) to lower quiescent current. See schematic following the "saturated operation plots".
Input Power (P_{IN})			14	dBm	Max. recommended continuous input power $V_{CC} < 5.0V$, Load VSWR < 2:1, R2 = 5.1 K Ω
Saturated Output Power		19.4		dBm	850MHz
		19.8		dBm	2140MHz
		19.8		dBm	2650MHz
Operating Current			90	mA	Max recommended current for continuous operation
Operating Voltage		5.0	5.25	V	Max recommended voltage for continuous operation

Typical Performance: 500MHz to 3000MHz Application Circuit
(Linear Operation, R2 = Open)

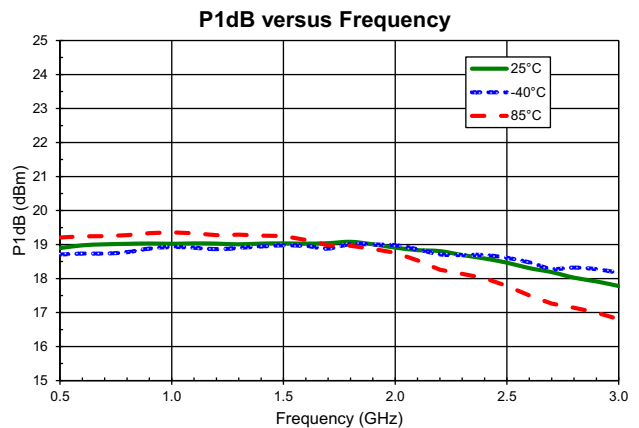
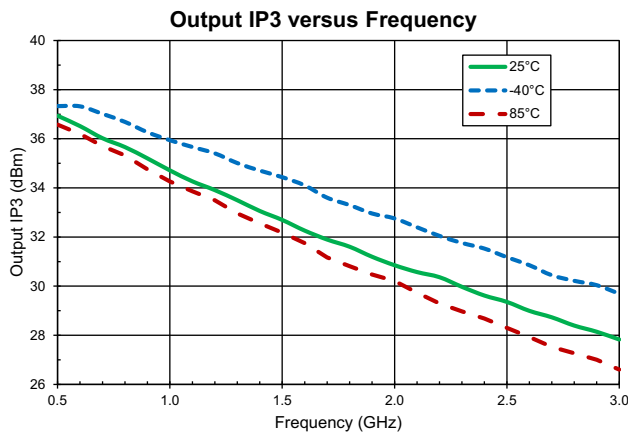
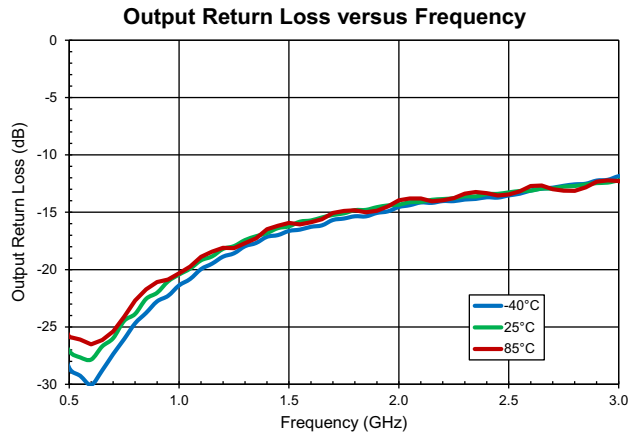
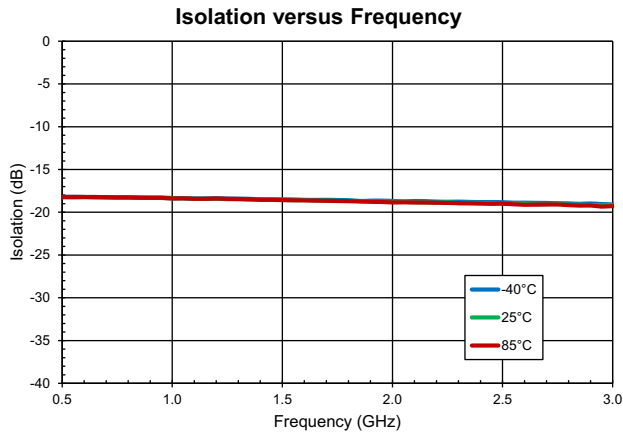
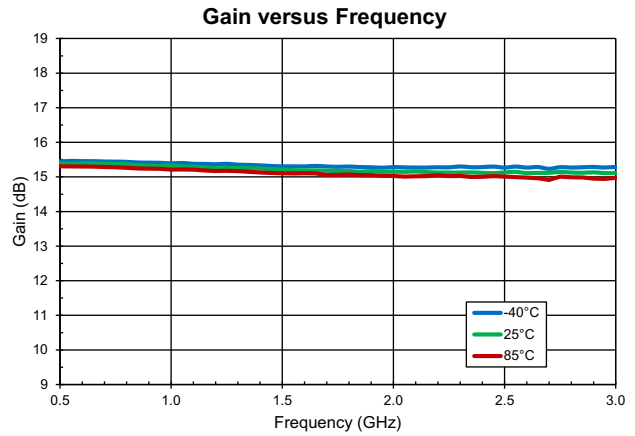
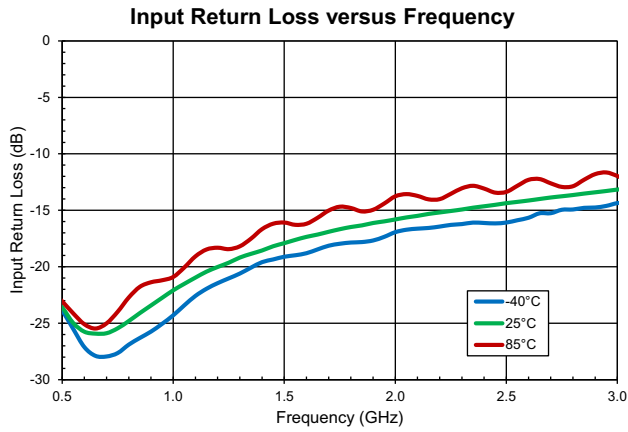

Typical Performance: 500MHz to 3000MHz Application Circuit (Linear Operation, R2 = Open)

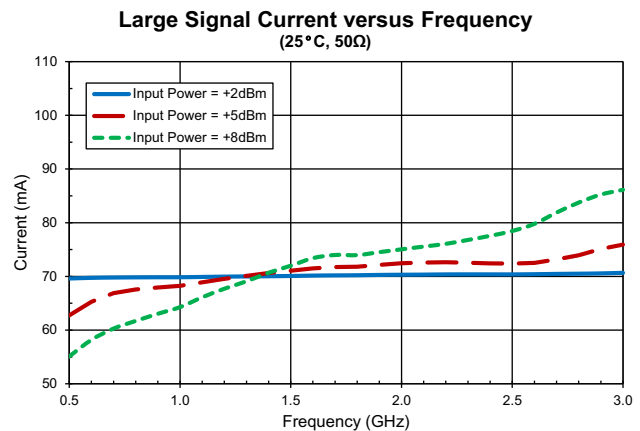
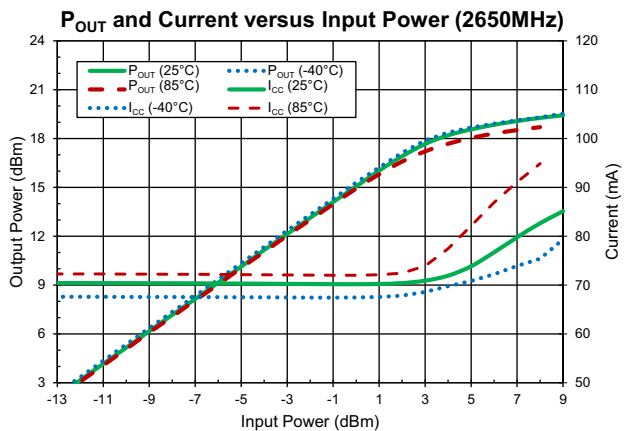
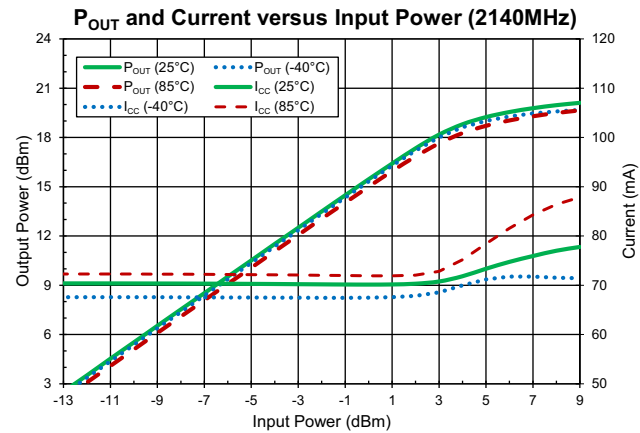
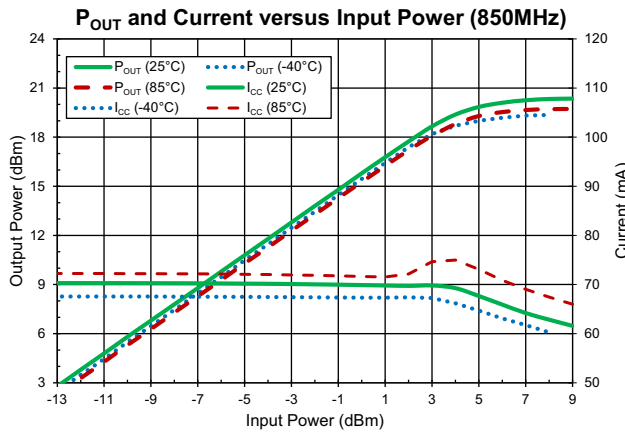
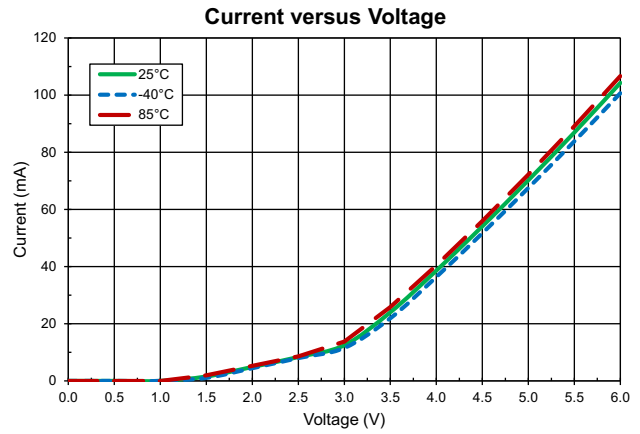
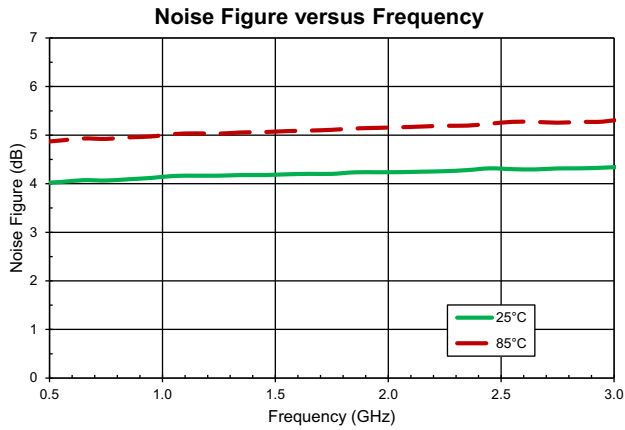

Evaluation Board Schematic

500MHz to 3000MHz Application Circuit for Linear Operation

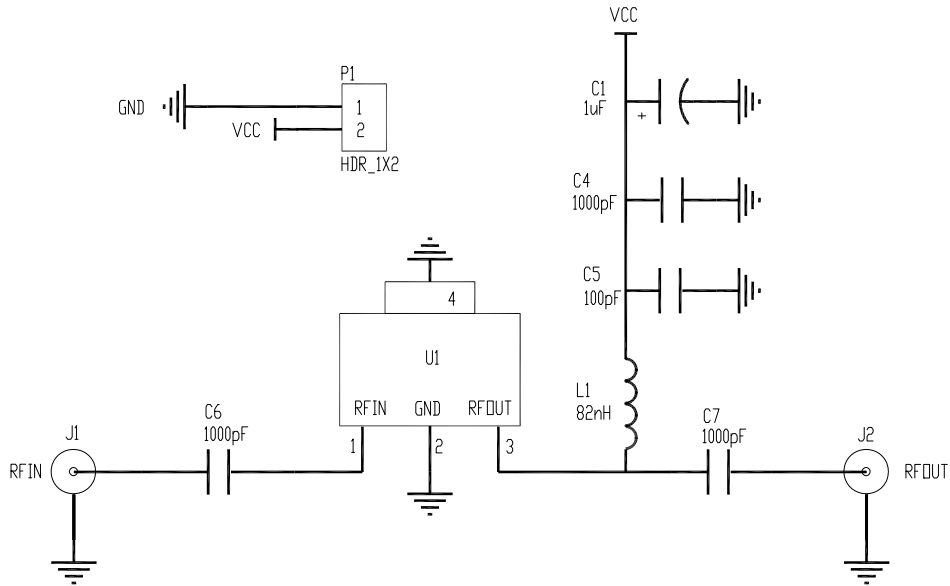

Evaluation Board Bill of Materials (BOM)

500MHz to 3000MHz Application Circuit

Description	Reference Designator	Manufacturer	Manufacturer's P/N
GA2054 Evaluation Board			GA2054-410(A)
CAP, 1μF, 20%, 25V, TANT-A	C1	AVX Corporation	TAJA105M025
CAP, 1000pF, 10%, 50V, X7R, 0402	C4, C6-C7	Taiyo Yuden (USA), Inc.	RM UMK105BJ102KV-F
CAP, 100pF, 5%, 50V, COG, 0402	C5	Taiyo Yuden (USA), Inc.	RM UMK105CG101JV-F
IND, 82nH, 10%, W/W, 0805	L1	Coilcraft, Inc.	0805CS-820XKBC
CONN, SMA, END LNCH, FLT, 0.062"	J1-J2	Johnson Components, Inc.	142-0701-821
CONN, HDR, ST, PLRZD, 2-PIN, 0.100"	P1	ITW Pancon	MPSS100-2-C
InGaP Darlington HBT Gain Block	U1	RFMD	GA2044
Do Not Place	C2-C3, R1-R2		

Evaluation Board Assembly Drawing

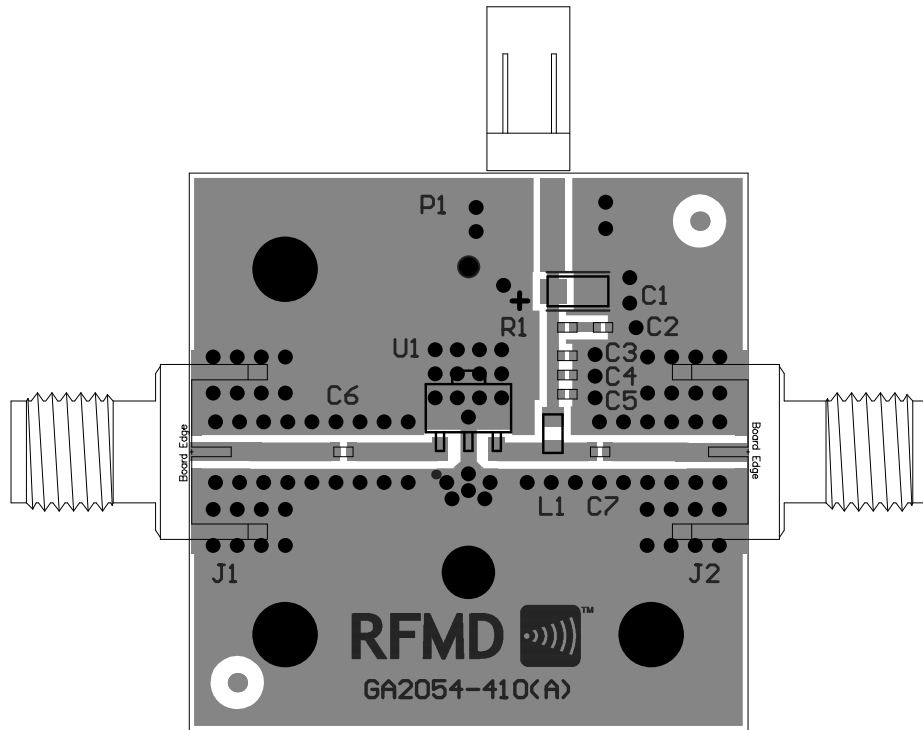

Pin Names and Descriptions

Pin	Name	Description
1	RF IN	RF Input. External DC block is required.
2	GND	DC and RF Ground
3	RF OUT/VCC	RF Output, Device Collector
4	GND	DC and RF Ground. Must be soldered to EVB ground plane over a bed of vias for thermal and RF performance.

Typical Performance under Saturated Operation, R2 = 5.1 KΩ

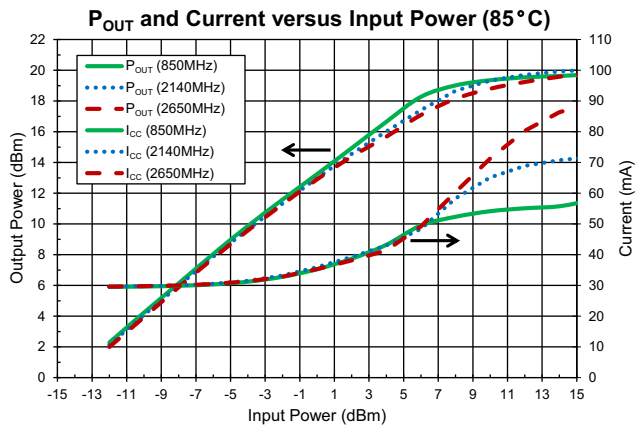
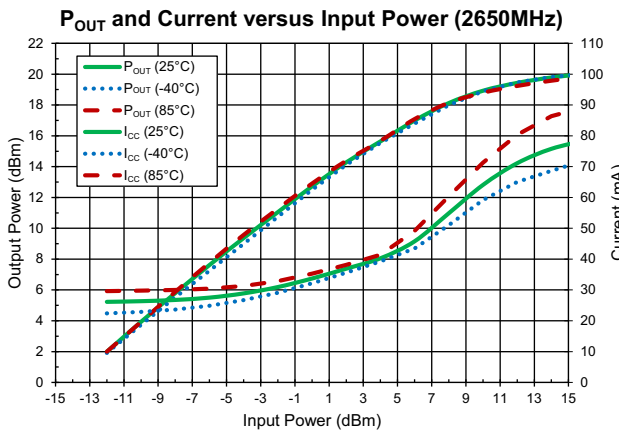
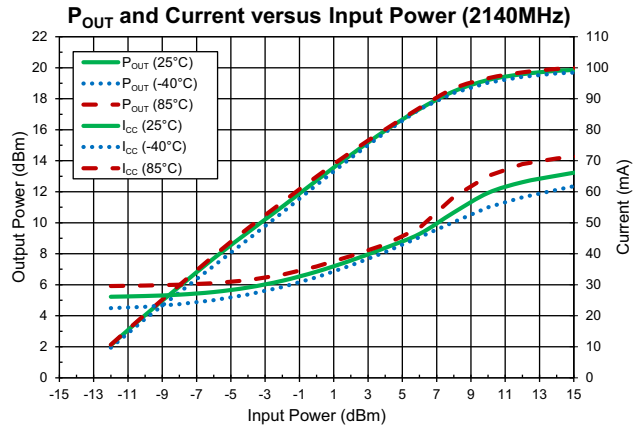
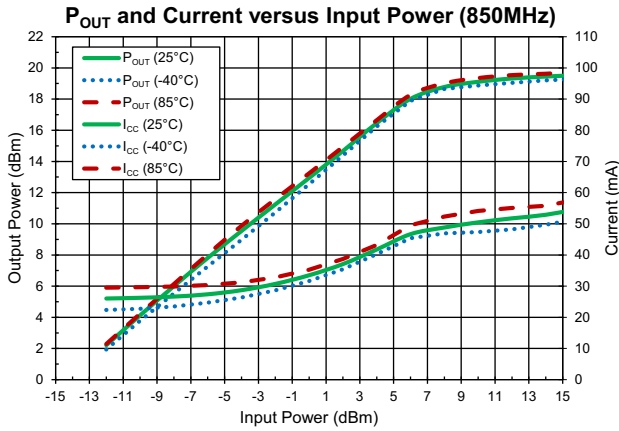

Evaluation Board Schematic for Saturated Operation

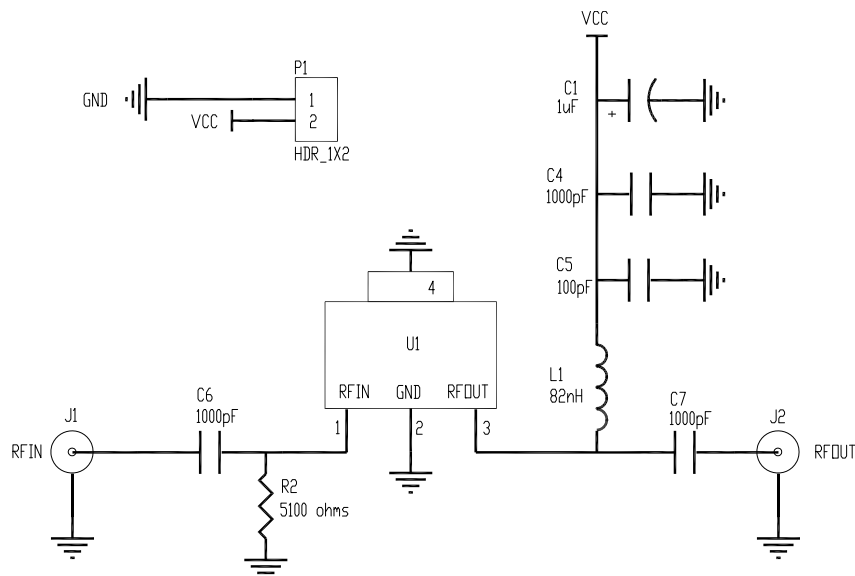

Branding Diagram

Trace Code to be assigned by the assembly SubCon.

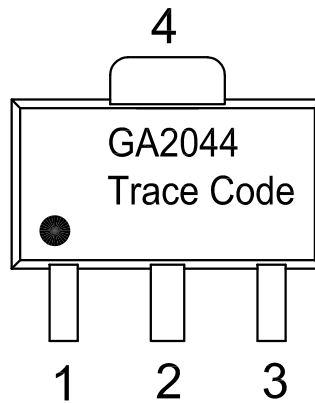

Package Drawing

Dimensions in millimeters [inches]

Refer to drawing posted at www.rfmd.com for tolerances.

