

# Aluminum electrolytic capacitors

## Single-ended capacitors

**Series/Type:** B41858  
**Date:** October 2015

© EPCOS AG 2015. Reproduction, publication and dissemination of this publication, enclosures hereto and the information contained therein without EPCOS' prior express consent is prohibited.

EPCOS AG is a TDK Group Company.

## Long-life grade capacitors

### Applications

- Automotive electronics
- For use in output circuits of switch-mode power supplies of compact design
- For professional industrial electronics, telecommunications and data processing equipment

### Features

- Low impedance at high frequency
- High reliability
- Low ESR
- High ripple current capability
- RoHS-compatible

### Construction

- Radial leads
- Charge-discharge proof, polar
- Aluminum case with insulating sleeve
- Minus pole marking on the insulating sleeve
- Case with safety vent

### Delivery mode

Terminal configurations and packing:

- Bulk
- Taped, Ammo pack
- Cut
- Kinked
- PAPR (protection against polarity reversal):  
crimped leads, J leads, bent leads

Refer to chapter "Single-ended capacitors – Taping, packing and lead configurations" for further details.

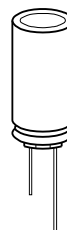

**Specifications and characteristics in brief**

Rated voltage $V_R$	10 ... 100 V DC							
Surge voltage $V_S$	$1.15 \cdot V_R$							
Rated capacitance $C_R$	22 ... 10000 $\mu\text{F}$							
Capacitance tolerance	$\pm 20\% \triangleq M$							
Dissipation factor $\tan \delta$ (20 °C, 120 Hz)	For capacitance higher than 1000 $\mu\text{F}$ add 0.02 for every increase of 1000 $\mu\text{F}$ .							
	$V_R$ (V DC)	10	16	25	35	50	63	100
	$\tan \delta$ (max.)	0.19	0.16	0.14	0.12	0.10	0.10	0.08
Leakage current $I_{\text{leak}}$ (20 °C, 5 min)	$I_{\text{leak}} = 0.01 \mu\text{A} \cdot \left( \frac{C_R}{\mu\text{F}} \cdot \frac{V_R}{V} \right)$							
Self-inductance ESL	Diameter (mm)	8 ... 12.5		16		18		
	ESL (nH)	20		26		34		
Useful life <sup>1)</sup> 105 °C; $V_R$ ; $I_{\text{AC,R}}$	<p>&gt; 3000 h for <math>d = 8</math> mm</p> <p>&gt; 5000 h for <math>d \geq 10</math> mm</p>							
Requirements	<p><math> \Delta C/C  \leq 40\%</math> of initial value</p> <p><math>\tan \delta \leq 3</math> times initial specified limit</p> <p><math>I_{\text{leak}} \leq</math> initial specified limit</p>							
Voltage endurance test 105 °C; $V_R$	<p>3000 h for <math>d = 8</math> mm</p> <p>5000 h for <math>d \geq 10</math> mm</p>							
Post test requirements	<p><math> \Delta C/C  \leq 30\%</math> of initial value</p> <p><math>\tan \delta \leq 2</math> times initial specified limit</p> <p><math>I_{\text{leak}} \leq</math> initial specified limit</p>							
Vibration resistance test	<p>To IEC 60068-2-6, test Fc:</p> <p>Frequency range 10 Hz ... 2 kHz, displacement amplitude max. 1.5 mm, acceleration max. 20 g, duration <math>3 \times 2</math> h.</p> <p>Capacitor rigidly clamped by the aluminum case.</p>							
IEC climatic category	<p>To IEC 60068-1:</p> <p>55/105/56 (–55 °C/+105 °C/56 days damp heat test)</p>							
Sectional specification	IEC 60384-4, AEC Q200							

1) Refer to chapter "General technical information, 5 Useful life" on how to interpret useful life.



**B41858**

**Low impedance – 105 °C**

### Dimensional drawings

#### With stand-off rubber seal

Diameters (mm): 10, 12.5, 16, 18

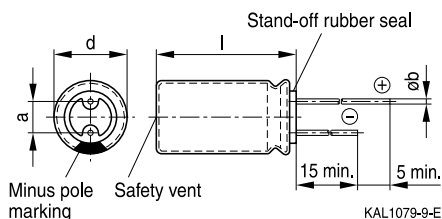

#### With flat rubber seal

Diameter (mm): 8

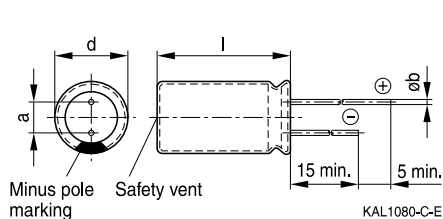

### Dimensions and weights

Dimensions (mm)				Approx. weight
d +0.5	l	a ±0.5	b	g
8	11.5 +1.5	3.5	0.60 ±0.05	1.0
10	12.5 +1.0	5.0	0.60 ±0.05	1.6
10	16 +1.0	5.0	0.60 ±0.05	1.9
10	20 +2.0	5.0	0.60 ±0.05	2.6
12.5	20 +2.0	5.0	0.60 ±0.05	3.6
12.5	25 +2.0	5.0	0.60 ±0.05	4.5
12.5	30 +2.0	5.0	0.80 ±0.05	5.3
12.5	40 +2.0	5.0	0.80 ±0.05	7.4
16	20 +2.0	7.5	0.80 ±0.05	5.5
16	25 +2.0	7.5	0.80 ±0.05	7.5
16	31.5 +2.0	7.5	0.80 ±0.05	7.8
16	35.5 +2.0	7.5	0.80 ±0.05	9.2
18	20 +2.0	7.5	0.80 ±0.1	8.0
18	25 +2.0	7.5	0.80 ±0.1	9.0
18	31.5 +2.0	7.5	0.80 ±0.1	11.0
18	35 +2.0	7.5	0.80 ±0.1	13.0
18	40 +2.0	7.5	0.80 ±0.1	16.0

**Overview of available types**

$V_R$ (V DC)	10	16	25	35
	Case dimensions $d \times l$ (mm)			
$C_R$ ( $\mu\text{F}$ )				
100				8 × 11.5
120				8 × 11.5
150				8 × 11.5
180			8 × 11.5	10 × 12.5
220			8 × 11.5	10 × 12.5
270		8 × 11.5	10 × 12.5	
330	8 × 11.5	8 × 11.5	10 × 12.5	10 × 16
390	8 × 11.5			
470	8 × 11.5	10 × 12.5	10 × 16	10 × 20
560	10 × 12.5	10 × 16	10 × 16	10 × 20
680	10 × 12.5	10 × 16	10 × 20	12.5 × 20
820	10 × 16	10 × 20	10 × 20	
1000	10 × 16	10 × 20	12.5 × 20	12.5 × 25 16 × 20
1200	10 × 16	10 × 20		16 × 20
1500	10 × 20	12.5 × 20	12.5 × 25	12.5 × 40 16 × 25
1800	10 × 20	12.5 × 25	16 × 20	16 × 25 18 × 20
2200	12.5 × 20	12.5 × 25	12.5 × 40 16 × 25 18 × 20	18 × 25
2700	12.5 × 25	16 × 20	16 × 31.5 18 × 20	18 × 31.5
3300	12.5 × 25 16 × 20	12.5 × 40 16 × 25	18 × 25	16 × 35.5 18 × 31.5
3900	12.5 × 40 16 × 20	16 × 31.5 18 × 20	16 × 35.5 18 × 31.5	18 × 35
4700	18 × 20	18 × 25	18 × 31.5	18 × 40
5600	12.5 × 40		18 × 35	
6800	16 × 31.5	18 × 31.5	18 × 40	
8200	18 × 31.5	18 × 35		
10000	18 × 35	18 × 40		

**B41858**
**Low impedance – 105 °C**

$V_R$ (V DC)	50	63	100
	Case dimensions $d \times l$ (mm)		
$C_R$ ( $\mu$ F)			
22			8 × 11.5
33			10 × 16
47			10 × 20
68		8 × 11.5	
100	8 × 11.5	10 × 12.5	12.5 × 20
120	10 × 12.5	10 × 16	12.5 × 25
150	10 × 12.5	10 × 16	
180	10 × 16	10 × 20	12.5 × 30 16 × 20
220	10 × 16	10 × 20	16 × 25
270		12.5 × 20	12.5 × 40 18 × 20
330	10 × 20	12.5 × 20	16 × 31.5 18 × 25
390		12.5 × 25	18 × 31.5
470	12.5 × 20	12.5 × 25 16 × 20	18 × 35
560	12.5 × 25		18 × 35
680	12.5 × 30	12.5 × 40 16 × 25 18 × 20	18 × 40
820	12.5 × 40 16 × 20	16 × 31.5 18 × 25	
1000	16 × 31.5 18 × 20	16 × 31.5	
1200	18 × 20	18 × 31.5	
1500	18 × 25	18 × 35	
1800	16 × 35.5 18 × 31.5	18 × 40	
2200	18 × 35		
2700	18 × 40		

Other voltage and capacitance ratings are available upon request.

**Technical data and ordering codes**

$C_R$	Case dimensions	$ESR_{max}$ 10 kHz –40 °C	$ESR_{max}$ 10 kHz 20 °C	$Z_{max}$ 100 kHz 20 °C	$I_{AC,R}$ 100 kHz 105 °C	Ordering code (composition see below)
$\mu F$	d × l mm	$\Omega$	$\Omega$	$\Omega$	mA	
<b><math>V_R = 10 V DC</math></b>						
330	8 × 11.5	2.195	0.274	0.246	436	B41858C3337M***
390	8 × 11.5	2.195	0.274	0.246	436	B41858C3397M***
470	8 × 11.5	2.195	0.274	0.246	436	B41858C3477M***
560	10 × 12.5	1.035	0.129	0.113	746	B41858C3567M***
680	10 × 12.5	1.035	0.129	0.113	746	B41858C3687M***
820	10 × 16	0.946	0.118	0.105	846	B41858C3827M***
1000	10 × 16	0.946	0.118	0.105	846	B41858C3108M***
1200	10 × 16	0.944	0.118	0.105	846	B41858C3128M***
1500	10 × 20	0.584	0.073	0.062	1202	B41858C3158M***
1800	10 × 20	0.584	0.073	0.062	1202	B41858C3188M***
2200	12.5 × 20	0.496	0.062	0.060	1396	B41858C3228M***
2700	12.5 × 25	0.327	0.041	0.034	2028	B41858C3278M***
3300	12.5 × 25	0.327	0.041	0.034	2028	B41858C3338M***
3300	16 × 20	0.307	0.038	0.033	2146	B41858D3338M***
3900	12.5 × 40	0.240	0.030	0.025	2858	B41858C3398M***
3900	16 × 20	0.307	0.038	0.033	2146	B41858D3398M***
4700	18 × 20	0.271	0.034	0.031	2381	B41858C3478M***
5600	12.5 × 40	0.243	0.030	0.025	2858	B41858C3568M***
6800	16 × 31.5	0.192	0.024	0.022	3122	B41858C3688M***
8200	18 × 31.5	0.165	0.021	0.020	3539	B41858C3828M***
10000	18 × 35	0.160	0.020	0.018	3864	B41858C3109M***

**Composition of ordering code**

\*\*\* = Version

000 = for standard leads, bulk

001 = for kinked leads, bulk (for d × l = 10 × 20 mm ... 18 × 40 mm, excluding 12.5 × 30/40 mm)

 002 = for cut leads, bulk (for  $\varnothing$  10 ... 18 mm, excluding d × l = 12.5 × 30/40 mm)

 003 = for crimped leads, blister (for  $\varnothing$  16 ... 18 mm)

 004 = for J leads, blister (for  $\varnothing$  10 ... 18 mm, excluding d × l = 12.5 × 30/40 and 18 × 40 mm)

 006 = for taped leads, Ammo pack, lead spacing F = 3.5 mm (for  $\varnothing$  8 mm)

008 = for taped leads, Ammo pack, lead spacing F = 5.0 mm (for d × l = 8 × 11.5 ... 12.5 × 25 mm)

009 = for taped leads, Ammo pack, lead spacing F = 7.5 mm (for d × l = 16 × 20 ... 16 × 31.5 mm and 18 × 20 ... 18 × 31.5 mm)

 012 = for bent 90° leads, blister (for  $\varnothing$  16 ... 18 mm)

**B41858**
**Low impedance – 105 °C**
**Technical data and ordering codes**

$C_R$	Case dimensions	$ESR_{max}$ 10 kHz -40 °C	$ESR_{max}$ 10 kHz 20 °C	$Z_{max}$ 100 kHz 20 °C	$I_{AC,R}$ 100 kHz 105 °C	Ordering code (composition see below)
$\mu F$	d × l mm	$\Omega$	$\Omega$	$\Omega$	mA	
<b><math>V_R = 16 V DC</math></b>						
270	8 × 11.5	2.192	0.274	0.246	436	B41858D4277M***
330	8 × 11.5	2.192	0.274	0.246	436	B41858D4337M***
470	10 × 12.5	1.035	0.129	0.113	746	B41858C4477M***
560	10 × 16	0.944	0.118	0.105	846	B41858C4567M***
680	10 × 16	0.946	0.118	0.105	846	B41858C4687M***
820	10 × 20	0.584	0.073	0.062	1202	B41858C4827M***
1000	10 × 20	0.584	0.073	0.062	1202	B41858C4108M***
1200	10 × 20	0.584	0.073	0.062	1202	B41858C4128M***
1500	12.5 × 20	0.496	0.062	0.060	1396	B41858C4158M***
1800	12.5 × 25	0.327	0.041	0.034	2028	B41858C4188M***
2200	12.5 × 25	0.327	0.041	0.034	2028	B41858C4228M***
2700	16 × 20	0.307	0.038	0.033	2146	B41858C4278M***
3300	12.5 × 40	0.243	0.030	0.025	2858	B41858D4338M***
3300	16 × 25	0.251	0.031	0.029	2483	B41858C4338M***
3900	16 × 31.5	0.192	0.024	0.022	3122	B41858D4398M***
3900	18 × 20	0.271	0.034	0.031	2381	B41858C4398M***
4700	18 × 25	0.217	0.027	0.024	2941	B41858C4478M***
6800	18 × 31.5	0.165	0.021	0.020	3539	B41858C4688M***
8200	18 × 35	0.160	0.020	0.018	3864	B41858C4828M***
10000	18 × 40	0.125	0.016	0.015	4467	B41858C4109M***

**Composition of ordering code**

\*\*\* = Version

- 000 = for standard leads, bulk
- 001 = for kinked leads, bulk (for d × l = 10 × 20 mm ... 18 × 40 mm, excluding 12.5 × 30/40 mm)
- 002 = for cut leads, bulk (for  $\varnothing$  10 ... 18 mm, excluding d × l = 12.5 × 30/40 mm)
- 003 = for crimped leads, blister (for  $\varnothing$  16 ... 18 mm)
- 004 = for J leads, blister (for  $\varnothing$  10 ... 18 mm, excluding d × l = 12.5 × 30/40 and 18 × 40 mm)
- 006 = for taped leads, Ammo pack, lead spacing F = 3.5 mm (for  $\varnothing$  8 mm)
- 008 = for taped leads, Ammo pack, lead spacing F = 5.0 mm (for d × l = 8 × 11.5 ... 12.5 × 25 mm)
- 009 = for taped leads, Ammo pack, lead spacing F = 7.5 mm (for d × l = 16 × 20 ... 16 × 31.5 mm and 18 × 20 ... 18 × 31.5 mm)
- 012 = for bent 90° leads, blister (for  $\varnothing$  16 ... 18 mm)



**Technical data and ordering codes**

$C_R$	Case dimensions	$ESR_{max}$ 10 kHz -40 °C	$ESR_{max}$ 10 kHz 20 °C	$Z_{max}$ 100 kHz 20 °C	$I_{AC,R}$ 100 kHz 105 °C	Ordering code (composition see below)
$\mu F$	$d \times l$ mm	$\Omega$	$\Omega$	$\Omega$	mA	
<b><math>V_R = 25 V DC</math></b>						
180	8 × 11.5	2.192	0.274	0.246	436	B41858D5187M***
220	8 × 11.5	2.192	0.274	0.246	436	B41858D5227M***
270	10 × 12.5	1.032	0.129	0.113	746	B41858C5277M***
330	10 × 12.5	1.035	0.129	0.113	746	B41858C5337M***
470	10 × 16	0.946	0.118	0.105	846	B41858C5477M***
560	10 × 16	0.944	0.118	0.105	846	B41858C5567M***
680	10 × 20	0.584	0.073	0.062	1202	B41858C5687M***
820	10 × 20	0.584	0.073	0.062	1202	B41858C5827M***
1000	12.5 × 20	0.496	0.062	0.060	1396	B41858C5108M***
1500	12.5 × 25	0.327	0.041	0.034	2028	B41858C5158M***
1800	16 × 20	0.307	0.038	0.033	2146	B41858C5188M***
2200	12.5 × 40	0.243	0.030	0.025	2858	B41858D5228M***
2200	16 × 25	0.251	0.031	0.029	2483	B41858C5228M***
2200	18 × 20	0.248	0.031	0.031	2381	B41858E5228M***
2700	16 × 31.5	0.192	0.024	0.022	3122	B41858D5278M***
2700	18 × 20	0.271	0.034	0.031	2381	B41858C5278M***
3300	18 × 25	0.217	0.027	0.024	2941	B41858C5338M***
3900	16 × 35.5	0.168	0.021	0.019	3408	B41858D5398M***
3900	18 × 31.5	0.165	0.021	0.020	3539	B41858C5398M***
4700	18 × 31.5	0.165	0.021	0.020	3539	B41858D5478M***
5600	18 × 35	0.160	0.020	0.018	3864	B41858D5568M***
6800	18 × 40	0.128	0.016	0.015	4467	B41858C5688M***

**Composition of ordering code**

\*\*\* = Version

- 000 = for standard leads, bulk
- 001 = for kinked leads, bulk (for  $d \times l = 10 \times 20$  mm ...  $18 \times 40$  mm, excluding  $12.5 \times 30/40$  mm)
- 002 = for cut leads, bulk (for  $\varnothing 10$  ... 18 mm, excluding  $d \times l = 12.5 \times 30/40$  mm)
- 003 = for crimped leads, blister (for  $\varnothing 16$  ... 18 mm)
- 004 = for J leads, blister (for  $\varnothing 10$  ... 18 mm, excluding  $d \times l = 12.5 \times 30/40$  and  $18 \times 40$  mm)
- 006 = for taped leads, Ammo pack, lead spacing  $F = 3.5$  mm (for  $\varnothing 8$  mm)
- 008 = for taped leads, Ammo pack, lead spacing  $F = 5.0$  mm (for  $d \times l = 8 \times 11.5$  ...  $12.5 \times 25$  mm)
- 009 = for taped leads, Ammo pack, lead spacing  $F = 7.5$  mm (for  $d \times l = 16 \times 20$  ...  $16 \times 31.5$  mm and  $18 \times 20$  ...  $18 \times 31.5$  mm)
- 012 = for bent 90° leads, blister (for  $\varnothing 16$  ... 18 mm)

**B41858**
**Low impedance – 105 °C**
**Technical data and ordering codes**

$C_R$	Case dimensions	$ESR_{max}$ 10 kHz -40 °C	$ESR_{max}$ 10 kHz 20 °C	$Z_{max}$ 100 kHz 20 °C	$I_{AC,R}$ 100 kHz 105 °C	Ordering code (composition see below)
$\mu F$	d × l mm	$\Omega$	$\Omega$	$\Omega$	mA	
<b><math>V_R = 35 V DC</math></b>						
100	8 × 11.5	2.192	0.274	0.246	436	B41858C7107M***
120	8 × 11.5	2.192	0.274	0.246	436	B41858D7127M***
150	8 × 11.5	2.192	0.274	0.246	436	B41858C7157M***
180	10 × 12.5	1.035	0.129	0.113	746	B41858C7187M***
220	10 × 12.5	1.035	0.129	0.113	746	B41858C7227M***
330	10 × 16	0.946	0.118	0.105	846	B41858C7337M***
470	10 × 20	0.584	0.073	0.062	1202	B41858C7477M***
560	10 × 20	0.584	0.073	0.062	1202	B41858C7567M***
680	12.5 × 20	0.496	0.062	0.060	1396	B41858C7687M***
1000	12.5 × 25	0.327	0.041	0.034	2028	B41858C7108M***
1000	16 × 20	0.304	0.038	0.033	2146	B41858D7108M***
1200	16 × 20	0.307	0.038	0.033	2146	B41858C7128M***
1500	12.5 × 40	0.243	0.030	0.025	2858	B41858D7158M***
1500	16 × 25	0.251	0.031	0.029	2483	B41858C7158M***
1800	16 × 25	0.248	0.031	0.029	2483	B41858E7188M***
1800	18 × 20	0.271	0.034	0.031	2381	B41858C7188M***
2200	18 × 25	0.217	0.027	0.024	2941	B41858C7228M***
2700	18 × 31.5	0.165	0.021	0.020	3539	B41858C7278M***
3300	16 × 35.5	0.168	0.021	0.019	3408	B41858E7338M***
3300	18 × 31.5	0.165	0.021	0.020	3539	B41858D7338M***
3900	18 × 35	0.160	0.020	0.018	3864	B41858C7398M***
4700	18 × 40	0.125	0.016	0.015	4467	B41858C7478M***

**Composition of ordering code**

\*\*\* = Version

- 000 = for standard leads, bulk
- 001 = for kinked leads, bulk (for d × l = 10 × 20 mm ... 18 × 40 mm, excluding 12.5 × 30/40 mm)
- 002 = for cut leads, bulk (for  $\varnothing$  10 ... 18 mm, excluding d × l = 12.5 × 30/40 mm)
- 003 = for crimped leads, blister (for  $\varnothing$  16 ... 18 mm)
- 004 = for J leads, blister (for  $\varnothing$  10 ... 18 mm, excluding d × l = 12.5 × 30/40 and 18 × 40 mm)
- 006 = for taped leads, Ammo pack, lead spacing F = 3.5 mm (for  $\varnothing$  8 mm)
- 008 = for taped leads, Ammo pack, lead spacing F = 5.0 mm (for d × l = 8 × 11.5 ... 12.5 × 25 mm)
- 009 = for taped leads, Ammo pack, lead spacing F = 7.5 mm (for d × l = 16 × 20 ... 16 × 31.5 mm and 18 × 20 ... 18 × 31.5 mm)
- 012 = for bent 90° leads, blister (for  $\varnothing$  16 ... 18 mm)

**Technical data and ordering codes**

$C_R$ 120 Hz 20 °C $\mu\text{F}$	Case dimensions $d \times l$ mm	$\text{ESR}_{\text{max}}$ 10 kHz –40 °C $\Omega$	$\text{ESR}_{\text{max}}$ 10 kHz 20 °C $\Omega$	$Z_{\text{max}}$ 100 kHz 20 °C $\Omega$	$I_{\text{AC,R}}$ 100 kHz 105 °C mA	Ordering code (composition see below)
<b><math>V_R = 50 \text{ V DC}</math></b>						
100	8 × 11.5	5.168	0.646	0.573	340	B41858C6107M***
120	10 × 12.5	2.984	0.373	0.336	555	B41858C6127M***
150	10 × 12.5	2.984	0.373	0.336	555	B41858C6157M***
180	10 × 16	1.400	0.175	0.160	778	B41858C6187M***
220	10 × 16	1.400	0.175	0.160	778	B41858C6227M***
330	10 × 20	1.000	0.125	0.118	1030	B41858C6337M***
470	12.5 × 20	0.880	0.110	0.104	1300	B41858C6477M***
560	12.5 × 25	0.712	0.089	0.082	1490	B41858C6567M***
680	12.5 × 30	0.360	0.045	0.043	2140	B41858C6687M***
820	12.5 × 40	0.269	0.034	0.032	2799	B41858C6827M***
820	16 × 20	0.401	0.050	0.046	1820	B41858D6827M***
1000	16 × 31.5	0.260	0.032	0.030	2653	B41858C6108M***
1000	18 × 20	0.477	0.048	0.044	1997	B41858D6108M***
1200	18 × 20	0.384	0.048	0.044	1997	B41858C6128M***
1500	18 × 25	0.382	0.038	0.036	2417	B41858C6158M***
1800	16 × 35.5	0.232	0.029	0.026	2896	B41858D6188M***
1800	18 × 31.5	0.300	0.030	0.028	2989	B41858C6188M***
2200	18 × 35	0.268	0.027	0.024	3320	B41858C6228M***
2700	18 × 40	0.210	0.021	0.020	3871	B41858C6278M***

**Composition of ordering code**

\*\*\* = Version

- 000 = for standard leads, bulk
- 001 = for kinked leads, bulk (for  $d \times l = 10 \times 20 \text{ mm} \dots 18 \times 40 \text{ mm}$ , excluding  $12.5 \times 30/40 \text{ mm}$ )
- 002 = for cut leads, bulk (for  $\varnothing 10 \dots 18 \text{ mm}$ , excluding  $d \times l = 12.5 \times 30/40 \text{ mm}$ )
- 003 = for crimped leads, blister (for  $\varnothing 16 \dots 18 \text{ mm}$ )
- 004 = for J leads, blister (for  $\varnothing 10 \dots 18 \text{ mm}$ , excluding  $d \times l = 12.5 \times 30/40$  and  $18 \times 40 \text{ mm}$ )
- 006 = for taped leads, Ammo pack, lead spacing  $F = 3.5 \text{ mm}$  (for  $\varnothing 8 \text{ mm}$ )
- 008 = for taped leads, Ammo pack, lead spacing  $F = 5.0 \text{ mm}$  (for  $d \times l = 8 \times 11.5 \dots 12.5 \times 25 \text{ mm}$ )
- 009 = for taped leads, Ammo pack, lead spacing  $F = 7.5 \text{ mm}$  (for  $d \times l = 16 \times 20 \dots 16 \times 31.5 \text{ mm}$  and  $18 \times 20 \dots 18 \times 31.5 \text{ mm}$ )
- 012 = for bent 90° leads, blister (for  $\varnothing 16 \dots 18 \text{ mm}$ )

**B41858**
**Low impedance – 105 °C**
**Technical data and ordering codes**

$C_R$	Case dimensions	$ESR_{max}$ 10 kHz -40 °C	$ESR_{max}$ 10 kHz 20 °C	$Z_{max}$ 100 kHz 20 °C	$I_{AC,R}$ 100 kHz 105 °C	Ordering code (composition see below)
$\mu F$	d × l mm	$\Omega$	$\Omega$	$\Omega$	mA	
<b><math>V_R = 63 V DC</math></b>						
68	8 × 11.5	4.328	0.541	0.488	310	B41858C8686M***
100	10 × 12.5	4.616	0.577	0.500	354	B41858C8107M***
120	10 × 16	3.075	0.308	0.279	519	B41858C8127M***
150	10 × 16	2.464	0.308	0.279	519	B41858C8157M***
180	10 × 20	1.986	0.199	0.180	705	B41858C8187M***
220	10 × 20	1.592	0.199	0.180	705	B41858C8227M***
270	12.5 × 20	1.688	0.169	0.153	876	B41858C8277M***
330	12.5 × 20	1.688	0.169	0.153	876	B41858C8337M***
390	12.5 × 25	1.236	0.124	0.112	1118	B41858C8397M***
470	12.5 × 25	0.992	0.124	0.112	1118	B41858E8477M***
470	16 × 20	1.037	0.104	0.094	1272	B41858C8477M***
680	12.5 × 40	0.717	0.072	0.065	1785	B41858C8687M***
680	16 × 25	0.772	0.077	0.070	1600	B41858D8687M***
680	18 × 20	0.960	0.096	0.087	1427	B41858E8687M***
820	16 × 31.5	0.541	0.054	0.049	2092	B41858C8827M***
820	18 × 25	0.761	0.076	0.069	1735	B41858D8827M***
1000	16 × 31.5	0.540	0.054	0.049	2092	B41858C8108M***
1200	18 × 31.5	0.518	0.052	0.047	2294	B41858C8128M***
1500	18 × 35	0.441	0.044	0.040	2592	B41858C8158M***
1800	18 × 40	0.375	0.038	0.034	2967	B41858C8188M***

**Composition of ordering code**

\*\*\* = Version

000 = for standard leads, bulk

001 = for kinked leads, bulk (for d × l = 10 × 20 mm ... 18 × 40 mm, excluding 12.5 × 30/40 mm)

 002 = for cut leads, bulk (for  $\varnothing$  10 ... 18 mm, excluding d × l = 12.5 × 30/40 mm)

 003 = for crimped leads, blister (for  $\varnothing$  16 ... 18 mm)

 004 = for J leads, blister (for  $\varnothing$  10 ... 18 mm, excluding d × l = 12.5 × 30/40 and 18 × 40 mm)

 006 = for taped leads, Ammo pack, lead spacing F = 3.5 mm (for  $\varnothing$  8 mm)

008 = for taped leads, Ammo pack, lead spacing F = 5.0 mm (for d × l = 8 × 11.5 ... 12.5 × 25 mm)

009 = for taped leads, Ammo pack, lead spacing F = 7.5 mm (for d × l = 16 × 20 ... 16 × 31.5 mm and 18 × 20 ... 18 × 31.5 mm)

 012 = for bent 90° leads, blister (for  $\varnothing$  16 ... 18 mm)

**Technical data and ordering codes**

$C_R$	Case dimensions	$ESR_{max}$ 10 kHz -40 °C	$ESR_{max}$ 10 kHz 20 °C	$Z_{max}$ 100 kHz 20 °C	$I_{AC,R}$ 100 kHz 105 °C	Ordering code (composition see below)
$\mu F$	d × l mm	$\Omega$	$\Omega$	$\Omega$	mA	
<b><math>V_R = 100 V DC</math></b>						
22	8 × 11.5	12.219	1.222	1.114	205	B41858C9226M***
33	10 × 16	6.542	0.654	0.589	357	B41858C9336M***
47	10 × 20	3.688	0.461	0.423	460	B41858C9476M***
100	12.5 × 20	3.048	0.305	0.281	647	B41858C9107M***
120	12.5 × 25	2.038	0.204	0.188	864	B41858C9127M***
180	12.5 × 30	1.732	0.173	0.159	1009	B41858C9187M***
180	16 × 20	1.313	0.131	0.122	1119	B41858D9187M***
220	16 × 25	0.985	0.099	0.091	1402	B41858C9227M***
270	12.5 × 40	1.314	0.131	0.121	1309	B41858C9277M***
270	18 × 20	1.260	0.126	0.119	1220	B41858D9277M***
330	16 × 31.5	0.973	0.097	0.090	1546	B41858C9337M***
330	18 × 25	1.008	0.101	0.095	1477	B41858D9337M***
390	18 × 31.5	0.720	0.072	0.068	1907	B41858C9397M***
470	18 × 35	0.679	0.068	0.063	2061	B41858C9477M***
560	18 × 35	0.679	0.068	0.063	2061	B41858C9567M***
680	18 × 40	0.438	0.044	0.042	2683	B41858C9687M***

**Composition of ordering code**

\*\*\* = Version

000 = for standard leads, bulk

001 = for kinked leads, bulk (for d × l = 10 × 20 mm ... 18 × 40 mm, excluding 12.5 × 30/40 mm)

 002 = for cut leads, bulk (for  $\varnothing$  10 ... 18 mm, excluding d × l = 12.5 × 30/40 mm)

 003 = for crimped leads, blister (for  $\varnothing$  16 ... 18 mm)

 004 = for J leads, blister (for  $\varnothing$  10 ... 18 mm, excluding d × l = 12.5 × 30/40 and 18 × 40 mm)

 006 = for taped leads, Ammo pack, lead spacing F = 3.5 mm (for  $\varnothing$  8 mm)

008 = for taped leads, Ammo pack, lead spacing F = 5.0 mm (for d × l = 8 × 11.5 ... 12.5 × 25 mm)

009 = for taped leads, Ammo pack, lead spacing F = 7.5 mm (for d × l = 16 × 20 ... 16 × 31.5 mm and 18 × 20 ... 18 × 31.5 mm)

 012 = for bent 90° leads, blister (for  $\varnothing$  16 ... 18 mm)

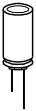

**B41858**

**Low impedance – 105 °C**

**Useful life<sup>1)</sup>**

depending on ambient temperature  $T_A$  under ripple current operating conditions

$d = 8 \text{ mm}$

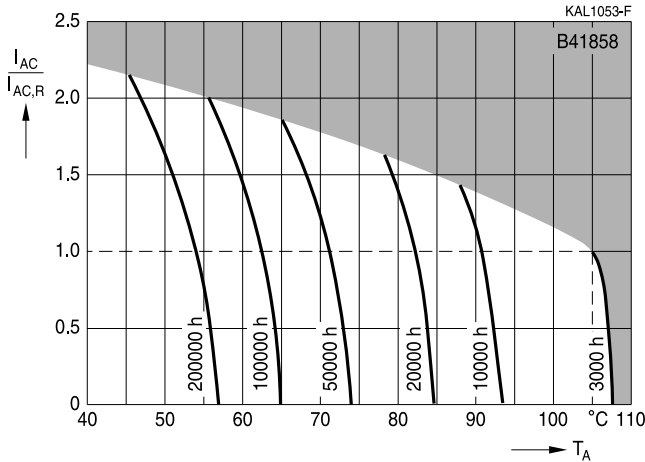

**Useful life<sup>1)</sup>**

depending on ambient temperature  $T_A$  under ripple current operating conditions

$d \geq 10 \text{ mm}$

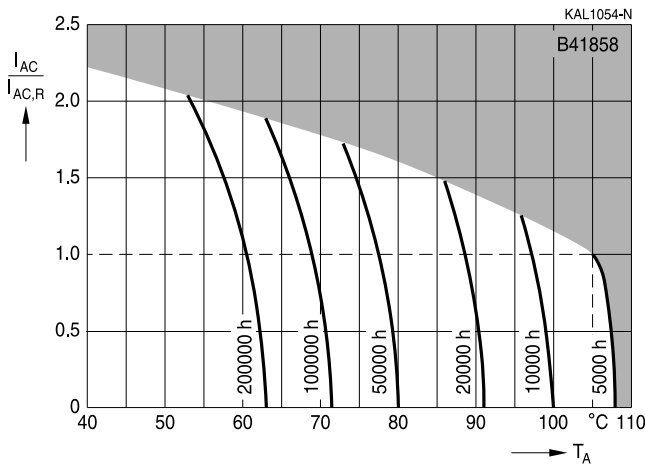

1) Refer to chapter "General technical information, 5 Useful life" on how to interpret useful life.



Frequency factor of permissible ripple current  $I_{AC}$  versus frequency  $f$

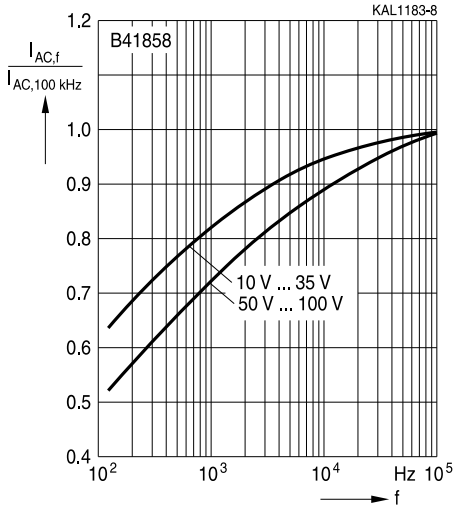



**B41858**

**Low impedance – 105 °C**

**Taping, packing and lead configurations**

**Taping**

Single-ended capacitors are available taped in Ammo pack from diameter 8 to 18 mm as follows:

Lead spacing  $F = 3.5 \text{ mm}$  ( $\varnothing d = 8 \text{ mm}$ )

Lead spacing  $F = 5.0 \text{ mm}$  ( $\varnothing d = 8 \dots 12.5 \text{ mm}$ )

Lead spacing  $F = 7.5 \text{ mm}$  ( $\varnothing d = 16 \dots 18 \text{ mm}$ ).

The dimensions for  $F$ ,  $P_1$  and  $1 \text{ max.}$  are specified with reference to the center of the terminal wires.

**Lead spacing 3.5 mm ( $\varnothing d = 8 \text{ mm}$ )**

Last 3 digits of ordering code: 006

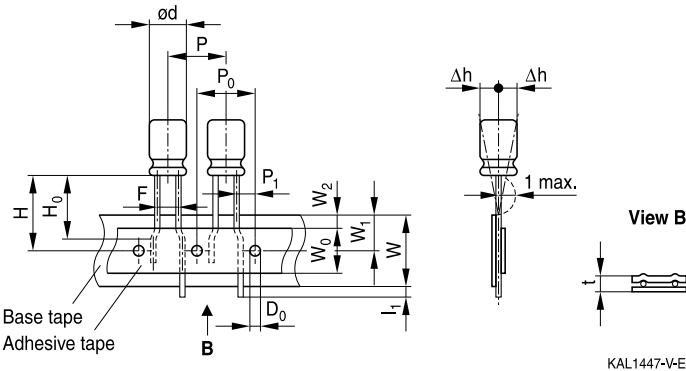

KAL1447-V-E

**Dimensions in mm**

$\varnothing d$	F	H	W	$W_0$	$W_1$	$W_2$	P	$P_0$	$P_1$	$l_1$	t	$\Delta h$	$D_0$
8	3.5	18.5	18.0	9.5	9.0	3.0	12.7	12.7	4.6	1.0	0.7	1.0	4.0
Tolerance	+0.8 -0.2	$\pm 1.0$	$\pm 0.5$	min.	$\pm 0.5$	max.	$\pm 1.0$	$\pm 0.3$	$\pm 0.6$	max.	$\pm 0.2$	max.	$\pm 0.2$

Leads can also run straight through the taping area.





B41858

Low impedance – 105 °C

**Lead spacing 5.0 mm (∅ d = 8 mm)**

Last 3 digits of ordering code: 008

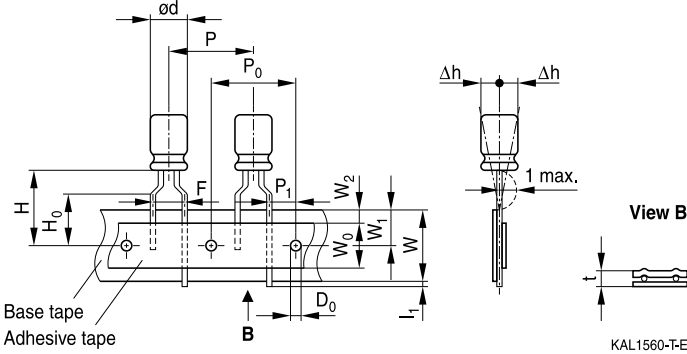

**Lead spacing 5.0 mm (∅ d = 10 ... 12.5 mm)**

Last 3 digits of ordering code: 008

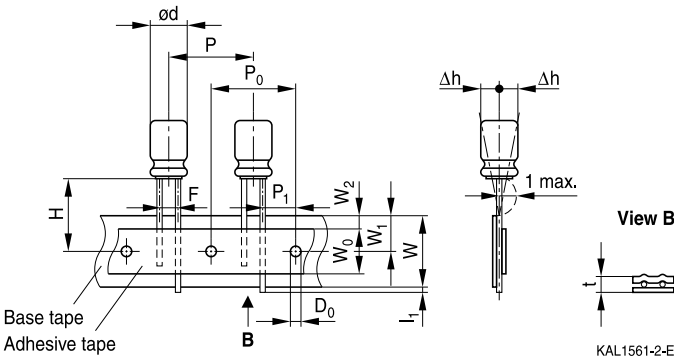

**Dimensions in mm**

∅ d	F	H	W	W <sub>0</sub>	W <sub>1</sub>	W <sub>2</sub>	H <sub>0</sub>	P	P <sub>0</sub>	P <sub>1</sub>	l <sub>1</sub>	t	Δh	D <sub>0</sub>
8		20.0		9.5			16.0	12.7	12.7	3.85				
10	5.0	19.0	18.0	9.5	9.0	1.5	–	12.7	12.7	3.85	1.0	0.6	1.0	4.0
12.5		19.0		11.5			–	15.0	15.0	5.0				
Tolerance	+0.8 –0.2	±0.75	±0.5	min.	±0.5	max.	±0.5	±1.0	±0.2	±0.5	max.	+0.3 –0.2	max.	±0.2

Taping is available up to dimensions d × l = 12.5 × 25 mm.



**B41858**

**Low impedance – 105 °C**

**Lead spacing 7.5 mm (∅ d = 16 ...18 mm)**

Last 3 digits of ordering code: 009

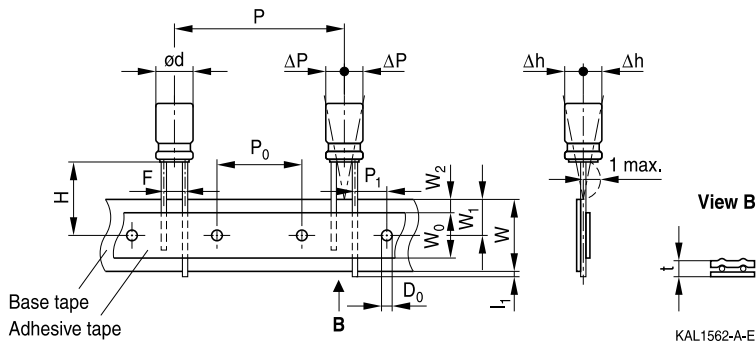

**Dimensions in mm**

∅ d	F	H	W	W <sub>0</sub>	W <sub>1</sub>	W <sub>2</sub>	P	P <sub>0</sub>	P <sub>1</sub>	l <sub>1</sub>	t	ΔP	Δh	D <sub>0</sub>
16	7.5	18.5	18.0	12.5	9.0	1.5	30.0	15.0	3.75	1.0	0.7	0	0	4.0
18														
Tolerance	±0.8	-0.5 +0.75	±0.5	min.	±0.5	max.	±1.0	±0.2	±0.5	max.	±0.2	±1.0	±1.0	±0.2

Taping is available up to dimensions d × l = 16 × 31.5 mm and 18 × 31.5 mm.



### Cut or kinked leads

Single-ended capacitors are available with cut or kinked leads. Other lead configurations also available upon request.

### Cut leads

Last 3 digits of ordering code: 002

#### With stand-off rubber seal

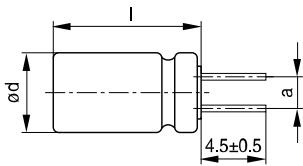

KAL1085-I

#### With flat rubber seal

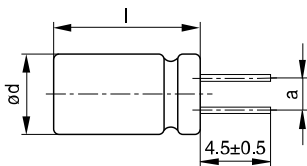

KAL1086-R

Case size d × l (mm)	Dimensions (mm) a ±0.5
10 × 12.5	5.0
10 × 16	5.0
10 × 20	5.0
12.5 × 20	5.0
12.5 × 25	5.0
16 × 20	7.5
16 × 25	7.5
16 × 31.5	7.5
16 × 35.5	7.5
18 × 20	7.5
18 × 25	7.5
18 × 31.5	7.5
18 × 35	7.5
18 × 40	7.5



**B41858**

**Low impedance – 105 °C**

**Kinked leads**

Last 3 digits of ordering code: 001

**With stand-off rubber seal**

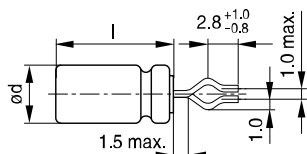

KAL1081-K

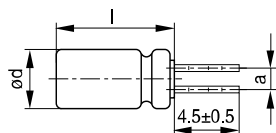

KAL1083-2

**With flat rubber seal**

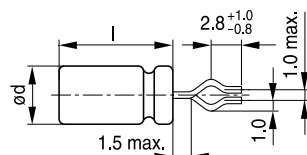

KAL1082-T

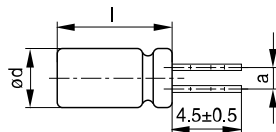

KAL1084-A

Case size d × l (mm)	Dimensions (mm) a ±0.5
10 × 20	5.0
12.5 × 20	5.0
12.5 × 25	5.0
16 × 20	7.5
16 × 25	7.5
16 × 31.5	7.5
16 × 35.5	7.5
18 × 20	7.5
18 × 25	7.5
18 × 31.5	7.5
18 × 35	7.5
18 × 40	7.5



**PAPR leads (Protection Against Polarity Reversal)**

These lead configurations ensure correct placement of the capacitor on the PCB with regard to polarity. PAPR leads are available for diameters from 10 mm up to 18 mm (excluding  $d \times l = 12.5 \times 30/35/40$  mm).

There are three configurations available: Crimped leads, J leads, bent 90° leads.

**Crimped leads**

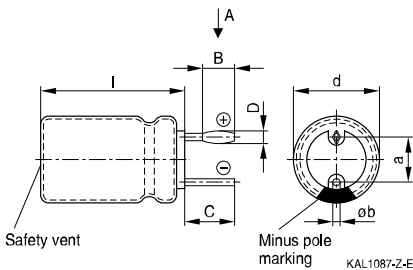
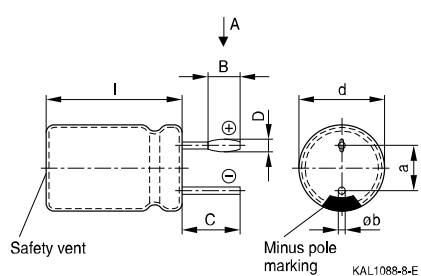
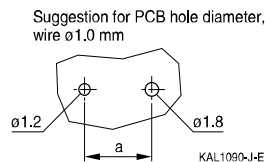
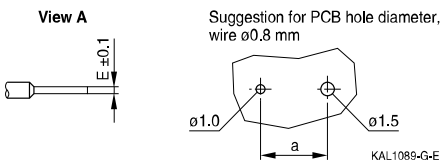
Last 3 digits of ordering code: 003

**With stand-off rubber seal**

**With flat rubber seal**

**Suggestion for PCB hole diameter**

Case size $d \times l$ (mm)	Dimensions (mm)					
	B $\pm 0.2$	C $\pm 0.5$	D $\pm 0.1$	E $\pm 0.1$	a $\pm 0.5$	$\varnothing b$
16 × 20	1.5	3.0	1.3	0.3	7.5	0.8 ± 0.05
16 × 25	1.5	3.0	1.3	0.3	7.5	0.8 ± 0.05
16 × 31.5	1.5	3.0	1.3	0.3	7.5	0.8 ± 0.05
16 × 35.5	1.5	3.0	1.3	0.3	7.5	0.8 ± 0.05
18 × 20	1.5	3.0	1.3	0.3	7.5	0.8 ± 0.1
18 × 25	1.5	3.0	1.3	0.3	7.5	0.8 ± 0.1
18 × 31.5	1.5	3.0	1.3	0.3	7.5	0.8 ± 0.1
18 × 35	1.5	3.0	1.3	0.3	7.5	0.8 ± 0.1
18 × 40	1.5	3.0	1.3	0.3	7.5	0.8 ± 0.1



**B41858**

**Low impedance – 105 °C**

**J leads**

Last 3 digits of ordering code: 004

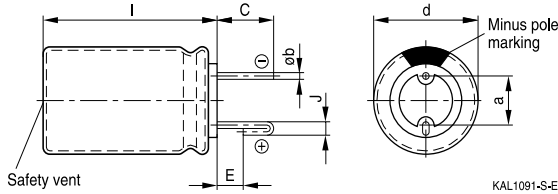

**Suggestion for PCB hole diameter**

Suggestion for PCB hole diameter, wire  $\varnothing 0.6$  mm

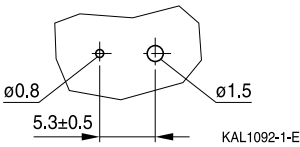

Suggestion for PCB hole diameter, wire  $\varnothing 0.8$  mm

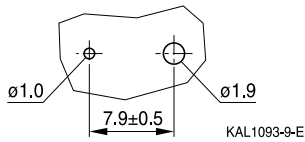

Case size d × l (mm)	Dimensions (mm)				
	C ±0.5	E ±0.5	J ±0.2	a ±0.5	∅b
10 × 12.5	3.2	0.7	1.2	5.0	0.6 ±0.05
10 × 16	3.2	0.7	1.2	5.0	0.6 ±0.05
10 × 20	3.2	0.7	1.2	5.0	0.6 ±0.05
12.5 × 20	3.2	0.7	1.2	5.0	0.6 ±0.05
12.5 × 25	3.2	0.7	1.2	5.0	0.6 ±0.05
16 × 20	3.5	0.7	1.6	7.5	0.8 ±0.05
16 × 25	3.5	0.7	1.6	7.5	0.8 ±0.05
16 × 31.5	3.5	0.7	1.6	7.5	0.8 ±0.05
16 × 35.5	3.5	0.7	1.6	7.5	0.8 ±0.05
18 × 20	3.5	0.7	1.6	7.5	0.8 ±0.1
18 × 25	3.5	0.7	1.6	7.5	0.8 ±0.1
18 × 31.5	3.5	0.7	1.6	7.5	0.8 ±0.1
18 × 35	3.5	0.7	1.6	7.5	0.8 ±0.1

**Bent 90° leads for horizontal mounting pinning**

Last 3 digits of ordering code: 012

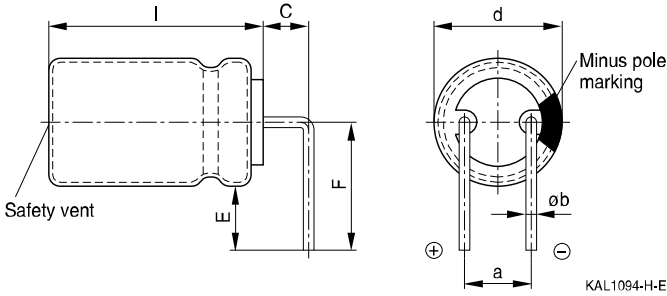

Case size d × l (mm)	Dimensions (mm)				
	C ±0.5	E ±0.5	F ±0.5	a ±0.5	Øb
16 × 20	4.0	4.0	12.0	7.5	0.8 ±0.05
16 × 25	4.0	4.0	12.0	7.5	0.8 ±0.05
16 × 31.5	4.0	4.0	12.0	7.5	0.8 ±0.05
16 × 35.5	4.0	4.0	12.0	7.5	0.8 ±0.05
18 × 20	4.0	4.0	13.0	7.5	0.8 ±0.1
18 × 25	4.0	4.0	13.0	7.5	0.8 ±0.1
18 × 31.5	4.0	4.0	13.0	7.5	0.8 ±0.1
18 × 35	4.0	4.0	13.0	7.5	0.8 ±0.1
18 × 40	4.0	4.0	13.0	7.5	0.8 ±0.1

Bent leads for diameter 12.5 mm available upon request.



**B41858**

**Low impedance – 105 °C**

**Packing units and box dimensions**

**Ammo pack**

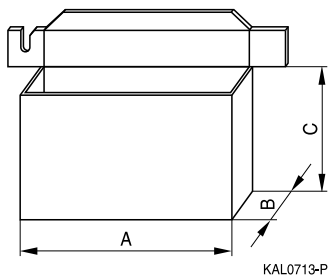

Case size d × l mm	Dimensions (mm)			Packing units pcs.
	A <sub>max</sub>	B <sub>max</sub>	C <sub>max</sub>	
8 × 11.5	345	60	240	1000
10 × 12.5	345	60	280	750
10 × 16	345	65	200	500
10 × 20	345	65	200	500
12.5 × 20	345	65	260	500
12.5 × 25	345	65	260	500
16 × 20	320	65	285	300
16 × 25	320	65	285	300
16 × 31.5	320	75	275	300
18 × 20	320	65	285	250
18 × 25	320	65	285	250
18 × 31.5	320	75	275	250



**Overview of packing units and code numbers for case sizes 8 × 11.5 ... 16 × 35.5**

					<b>PAPR</b>				
Case size d × l	Stan- dard, bulk	Taped, Ammo pack	Kinked leads, bulk	Cut leads, bulk	Crimped leads, blister	J leads, blister	Bent 90° leads, blister		
mm	pcs.	pcs.	pcs.	pcs.	pcs.	pcs.	pcs.		
8 × 11.5	1000	1000	–	–	–	–			
10 × 12.5	1000	750	–	1000	–	675			
10 × 16	1000	500	–	1000	–	675			
10 × 20	500	500	500	500	–	500			
12.5 × 20	350	500	350	350	–	300	1)		
12.5 × 25	250	500	500	500	–	225	1)		
12.5 × 30	200	–	–	–	–	–			
12.5 × 35	175	–	–	–	–	–			
12.5 × 40	175	–	–	–	–	–			
16 × 20	250	300	200	200	200	200	120		
16 × 25	250	300	200	200	200	200	216		
16 × 31.5	200	300	250	250	344	344	180		
16 × 35.5	100	–	100	100	150	150	150		
The last three digits of the complete ordering code state the lead configuration	<b>000</b>	Code	F (mm)	d (mm)	<b>001</b>	<b>002</b>	<b>003</b>	<b>004</b>	<b>012</b>
		<b>006</b>	3.5	8					
		<b>008</b>	5	8...12.5					
		<b>009</b>	7.5	16...18					

1) Available upon request



**B41858**

**Low impedance – 105 °C**

**Overview of packing units and code numbers for case sizes 18 × 20 ... 18 × 40**

					<b>PAPR</b>				
Case size d × l  mm	Standard, bulk pcs.	Taped, Ammo pack pcs.			Kinked leads, bulk pcs.	Cut leads, bulk pcs.	Crimped leads, blister pcs.	J leads, blister pcs.	Bent 90° leads, blister pcs.
18 × 20	175	250			175	175	200	200	120
18 × 25	150	250			150	150	200	200	120
18 × 31.5	100	250			100	100	150	150	120
18 × 35	100	–			100	100	150	150	150
18 × 40	125	–			100	100	120	–	72
The last three digits of the complete ordering code state the lead configuration	<b>000</b>	Code	F (mm)	d (mm)	<b>001</b>	<b>002</b>	<b>003</b>	<b>004</b>	<b>012</b>
		<b>009</b>	7.5	16...18					



## Cautions and warnings

### Personal safety

The electrolytes used by EPCOS have been optimized both with a view to the intended application and with regard to health and environmental compatibility. They do not contain any solvents that are detrimental to health, e.g. dimethyl formamide (DMF) or dimethyl acetamide (DMAC).

Furthermore, some of the high-voltage electrolytes used by EPCOS are self-extinguishing.

As far as possible, EPCOS does not use any dangerous chemicals or compounds to produce operating electrolytes. However, in exceptional cases, such materials must be used in order to achieve specific physical and electrical properties because no alternative materials are currently known. However, the amount of dangerous materials used in our products is limited to an absolute minimum.

Materials and chemicals used in EPCOS aluminum electrolytic capacitors are continuously adapted in compliance with the EPCOS Corporate Environmental Policy and the latest EU regulations and guidelines such as RoHS, REACH/SVHC, GADSL, and ELV.

MDS (Material Data Sheets) are available on the EPCOS website for all types listed in the data book. MDS for customer specific capacitors are available upon request.

MSDS (Material Safety Data Sheets) are available for all of our electrolytes upon request.

Nevertheless, the following rules should be observed when handling aluminum electrolytic capacitors: No electrolyte should come into contact with eyes or skin. If electrolyte does come into contact with the skin, wash the affected areas immediately with running water. If the eyes are affected, rinse them for 10 minutes with plenty of water. If symptoms persist, seek medical treatment. Avoid inhaling electrolyte vapor or mists. Workplaces and other affected areas should be well ventilated. Clothing that has been contaminated by electrolyte must be changed and rinsed in water.



**B41858**

**Low impedance – 105 °C**

### Product safety

The table below summarizes the safety instructions that must be observed without fail. A detailed description can be found in the relevant sections of chapter "General technical information".

Topic	Safety information	Reference chapter "General technical information"
Polarity	Make sure that polar capacitors are connected with the right polarity.	1 "Basic construction of aluminum electrolytic capacitors"
Reverse voltage	Voltages of opposite polarity should be prevented by connecting a diode.	3.1.6 "Reverse voltage"
Mounting position of screw-terminal capacitors	Screw terminal capacitors must not be mounted with terminals facing down unless otherwise specified.	11.1. "Mounting positions of capacitors with screw terminals"
Robustness of terminals	The following maximum tightening torques must not be exceeded when connecting screw terminals: M5: 2.5 Nm M6: 4.0 Nm	11.3 "Mounting torques"
Mounting of single-ended capacitors	The internal structure of single-ended capacitors might be damaged if excessive force is applied to the lead wires. Avoid any compressive, tensile or flexural stress. Do not move the capacitor after soldering to PC board. Do not pick up the PC board by the soldered capacitor. Do not insert the capacitor on the PC board with a hole space different to the lead space specified.	11.4 "Mounting considerations for single-ended capacitors"
Soldering	Do not exceed the specified time or temperature limits during soldering.	11.5 "Soldering"
Soldering, cleaning agents	Do not allow halogenated hydrocarbons to come into contact with aluminum electrolytic capacitors.	11.6 "Cleaning agents"
Upper category temperature	Do not exceed the upper category temperature.	7.2 "Maximum permissible operating temperature"
Passive flammability	Avoid external energy, e.g. fire.	8.1 "Passive flammability"



Topic	Safety information	Reference chapter "General technical information"
Active flammability	Avoid overload of the capacitors.	8.2 "Active flammability"
Maintenance	Make periodic inspections of the capacitors. Before the inspection, make sure that the power supply is turned off and carefully discharge the electricity of the capacitors. Do not apply excessive mechanical stress to the capacitor terminals when mounting.	10 "Maintenance"
Storage	Do not store capacitors at high temperatures or high humidity. Capacitors should be stored at +5 to +35 °C and a relative humidity of $\leq 75\%$ .	7.3 "Shelf life and storage conditions"
		Reference chapter "Capacitors with screw terminals"
Breakdown strength of insulating sleeves	Do not damage the insulating sleeve, especially when ring clips are used for mounting.	"Screw terminals – accessories"

### Display of ordering codes for EPCOS products

The ordering code for one and the same product can be represented differently in data sheets, data books, other publications and the website of EPCOS, or in order-related documents such as shipping notes, order confirmations and product labels. The varying representations of the ordering codes are due to different processes employed and do not affect the specifications of the respective products. Detailed information can be found on the Internet under [www.epcos.com/orderingcodes](http://www.epcos.com/orderingcodes).



**B41858**

**Low impedance – 105 °C**

## Symbols and terms

Symbol	English	German
C	Capacitance	Kapazität
$C_R$	Rated capacitance	Nennkapazität
$C_S$	Series capacitance	Serienkapazität
$C_{S,T}$	Series capacitance at temperature T	Serienkapazität bei Temperatur T
$C_f$	Capacitance at frequency f	Kapazität bei Frequenz f
d	Case diameter, nominal dimension	Gehäusedurchmesser, Nennmaß
$d_{max}$	Maximum case diameter	Maximaler Gehäusedurchmesser
ESL	Self-inductance	Eigeninduktivität
ESR	Equivalent series resistance	Ersatzserienwiderstand
$ESR_f$	Equivalent series resistance at frequency f	Ersatzserienwiderstand bei Frequenz f
$ESR_T$	Equivalent series resistance at temperature T	Ersatzserienwiderstand bei Temperatur T
f	Frequency	Frequenz
I	Current	Strom
$I_{AC}$	Alternating current (ripple current)	Wechselstrom
$I_{AC,RMS}$	Root-mean-square value of alternating current	Wechselstrom, Effektivwert
$I_{AC,f}$	Ripple current at frequency f	Wechselstrom bei Frequenz f
$I_{AC,max}$	Maximum permissible ripple current	Maximal zulässiger Wechselstrom
$I_{AC,R}$	Rated ripple current	Nennwechselstrom
$I_{leak}$	Leakage current	Reststrom
$I_{leak,op}$	Operating leakage current	Betriebsreststrom
l	Case length, nominal dimension	Gehäuselänge, Nennmaß
$l_{max}$	Maximum case length (without terminals and mounting stud)	Maximale Gehäuselänge (ohne Anschlüsse und Gewindebolzen)
R	Resistance	Widerstand
$R_{ins}$	Insulation resistance	Isolationswiderstand
$R_{symm}$	Balancing resistance	Symmetrierwiderstand
T	Temperature	Temperatur
$\Delta T$	Temperature difference	Temperaturdifferenz
$T_A$	Ambient temperature	Umgebungstemperatur
$T_C$	Case temperature	Gehäusetemperatur
$T_B$	Capacitor base temperature	Temperatur des Gehäusebodens
t	Time	Zeit
$\Delta t$	Period	Zeitraum
$t_b$	Service life (operating hours)	Brauchbarkeitsdauer (Betriebszeit)



Symbol	English	German
V	Voltage	Spannung
V <sub>F</sub>	Forming voltage	Formierspannung
V <sub>op</sub>	Operating voltage	Betriebsspannung
V <sub>R</sub>	Rated voltage, DC voltage	Nennspannung, Gleichspannung
V <sub>S</sub>	Surge voltage	Spitzenspannung
X <sub>C</sub>	Capacitive reactance	Kapazitiver Blindwiderstand
X <sub>L</sub>	Inductive reactance	Induktiver Blindwiderstand
Z	Impedance	Scheinwiderstand
Z <sub>T</sub>	Impedance at temperature T	Scheinwiderstand bei Temperatur T
tan δ	Dissipation factor	Verlustfaktor
λ	Failure rate	Ausfallrate
ε <sub>0</sub>	Absolute permittivity	Elektrische Feldkonstante
ε <sub>r</sub>	Relative permittivity	Dielektrizitätszahl
ω	Angular velocity; 2 · π · f	Kreisfrequenz; 2 · π · f

**Note**

All dimensions are given in mm.

## Important notes

The following applies to all products named in this publication:

1. Some parts of this publication contain **statements about the suitability of our products for certain areas of application**. These statements are based on our knowledge of typical requirements that are often placed on our products in the areas of application concerned. We nevertheless expressly point out **that such statements cannot be regarded as binding statements about the suitability of our products for a particular customer application**. As a rule, EPCOS is either unfamiliar with individual customer applications or less familiar with them than the customers themselves. For these reasons, it is always ultimately incumbent on the customer to check and decide whether an EPCOS product with the properties described in the product specification is suitable for use in a particular customer application.
2. We also point out that **in individual cases, a malfunction of electronic components or failure before the end of their usual service life cannot be completely ruled out in the current state of the art, even if they are operated as specified**. In customer applications requiring a very high level of operational safety and especially in customer applications in which the malfunction or failure of an electronic component could endanger human life or health (e.g. in accident prevention or lifesaving systems), it must therefore be ensured by means of suitable design of the customer application or other action taken by the customer (e.g. installation of protective circuitry or redundancy) that no injury or damage is sustained by third parties in the event of malfunction or failure of an electronic component.
3. **The warnings, cautions and product-specific notes must be observed.**
4. In order to satisfy certain technical requirements, **some of the products described in this publication may contain substances subject to restrictions in certain jurisdictions (e.g. because they are classed as hazardous)**. Useful information on this will be found in our Material Data Sheets on the Internet ([www.epcos.com/material](http://www.epcos.com/material)). Should you have any more detailed questions, please contact our sales offices.
5. We constantly strive to improve our products. Consequently, **the products described in this publication may change from time to time**. The same is true of the corresponding product specifications. Please check therefore to what extent product descriptions and specifications contained in this publication are still applicable before or when you place an order. We also **reserve the right to discontinue production and delivery of products**. Consequently, we cannot guarantee that all products named in this publication will always be available. The aforementioned does not apply in the case of individual agreements deviating from the foregoing for customer-specific products.
6. Unless otherwise agreed in individual contracts, **all orders are subject to the current version of the "General Terms of Delivery for Products and Services in the Electrical Industry" published by the German Electrical and Electronics Industry Association (ZVEI)**.



## Important notes

7. The trade names EPCOS, Alu-X, CeraDiode, CeraLink, CeraPad, CeraPlas, CSMP, CSSP, CTVS, DeltaCap, DigiSiMic, DSSP, ExoCore, FilterCap, FormFit, LeaXield, MiniBlue, MiniCell, MKD, MKK, MotorCap, PCC, PhaseCap, PhaseCube, PhaseMod, PhiCap, PQSine, SIFERRIT, SIFI, SIKOREL, SilverCap, SIMDAD, SiMic, SIMID, SineFormer, SIOV, SIP5D, SIP5K, TFAP, ThermoFuse, WindCap are **trademarks registered or pending** in Europe and in other countries. Further information will be found on the Internet at [www.epcos.com/trademarks](http://www.epcos.com/trademarks).