

### 1. PART NO. EXPRESSION :

L 201210 1R0 M - □□  
 (a) (b) (c) (d) (e)

(a) Series code

(b) Dimension code

(c) Inductance code : 1R0 = 1.0uH

(d) Tolerance code : M = ±20%

(e) 10: Standard

11 ~ 99 : Internal control number

### 2. CONFIGURATION & DIMENSIONS :

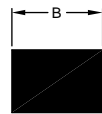
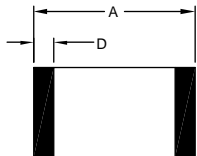

Unit:m/m

A	B	C	D
2.0 ±0.2	1.25 ±0.2	0.9±0.1	0.50 ±0.2

### 3. SCHEMATIC :

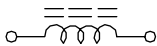

### 4. MATERIALS :

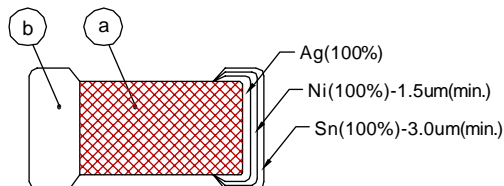

(a) Body : Ferrite

(b) Termination : Ag/Ni/Sn

### 5. GENERAL SPECIFICATION :

- a) Operating temp. : -55° C to +125° C
- b) Storage condition (component in its packaging)
  - i) Temperature : -10 to 40° C
  - ii) Humidity : 60%



**RoHS Compliant**

NOTE : Specifications subject to change without notice. Please check our website for latest information.

30.01.2015



**SUPERWORLD ELECTRONICS (S) PTE LTD**

## 6. ELECTRICAL CHARACTERISTICS :

Part Number	Inductance (μH)	Test Frequency (MHz)	Rated Current (mA) Max	DC Resistance (Ω)	SRF (MHz) Min
L201210R47M-10	0.47 ± 20%	1	1100	0.10 ± 25%	100
L201210R68M-10	0.68 ± 20%	1	1000	0.12 ± 25%	100
L201210R82M-10	0.82 ± 20%	1	900	0.14 ± 25%	90
L2012101R0M-10	1.0 ± 20%	1	800	0.16 ± 25%	90
L2012101R2M-10	1.2 ± 20%	1	800	0.16 ± 25%	80
L2012101R5M-10	1.5 ± 20%	1	700	0.22 ± 25%	70
L2012101R8M-10	1.8 ± 20%	1	700	0.22 ± 25%	60
L2012102R2M-10	2.2 ± 20%	1	600	0.25 ± 25%	50
L2012103R3M-10	3.3 ± 20%	1	500	0.22 ± 25%	40
L2012104R7M-10	4.7 ± 20%	1	500	0.30 ± 25%	30



**RoHS Compliant**

NOTE : Specifications subject to change without notice. Please check our website for latest information.

30.01.2015



**SUPERWORLD ELECTRONICS (S) PTE LTD**

## 7. CHARACTERISTICS CURVES :

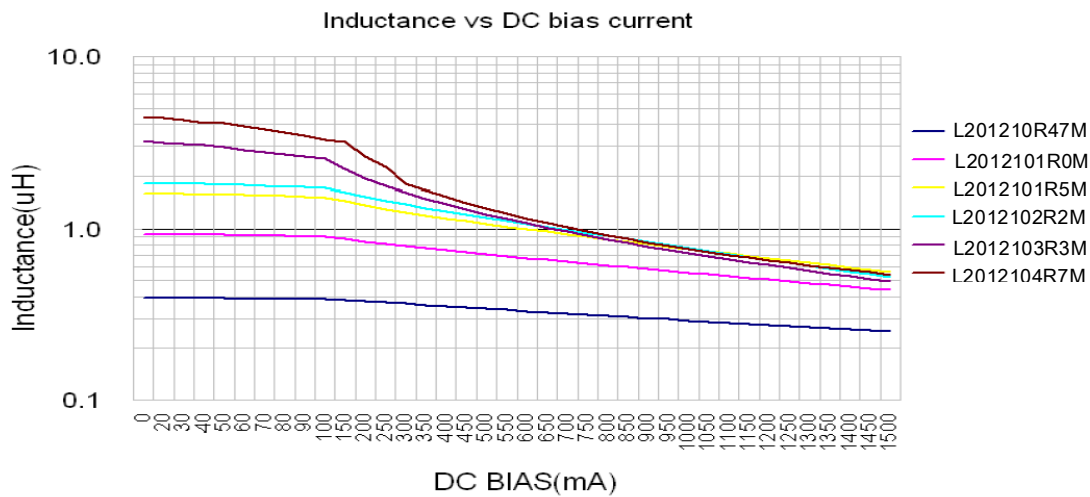
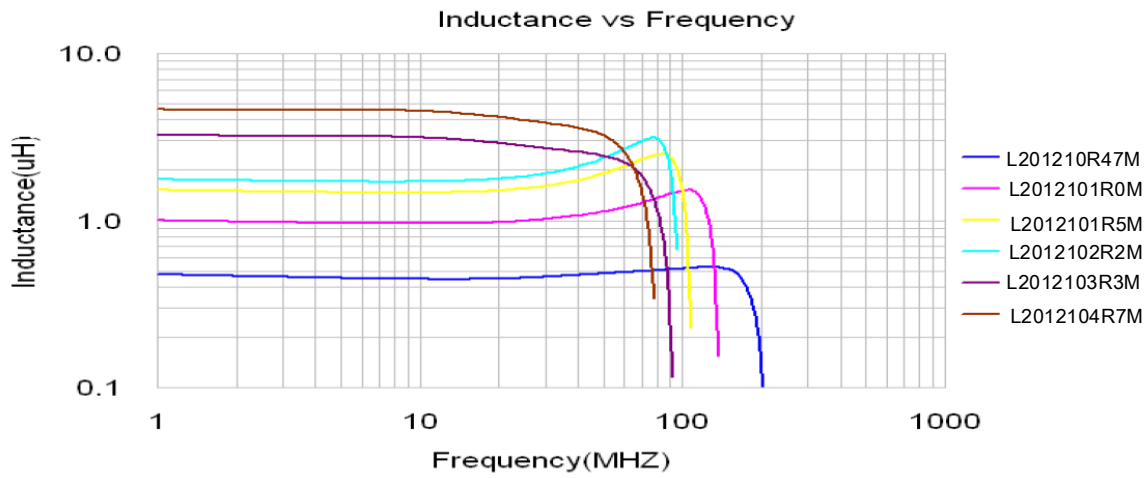

**RoHS Compliant**

NOTE : Specifications subject to change without notice. Please check our website for latest information.

30.01.2015



**SUPERWORLD ELECTRONICS (S) PTE LTD**

## 8. SOLDERING AND MOUNTING :

### 8-1. Reflow soldering conditions

Pre-heating should be in such a way that the temperature difference between solder and ferrite surface is limited to 150° C max. Also cooling into the solvent after soldering should be in such a way that the temperature difference is limited to 100° C max. Insufficient pre-heating may cause cracks on the ferrite, resulting in the deterioration of product quality.

Products should be soldered within the following allowable range indicated by the slanted line. The excessive soldering conditions may cause the corrosion of the electrode. When soldering is repeated, allowable time is the accumulated time.

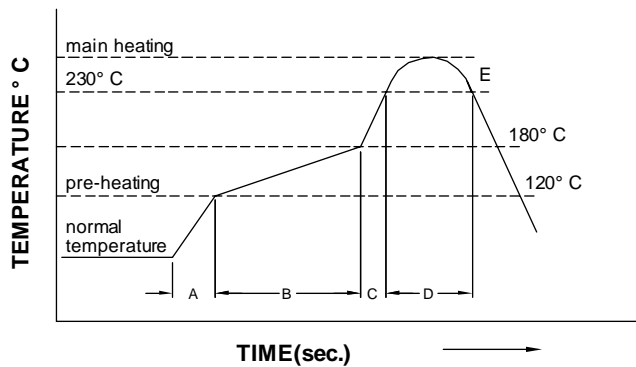
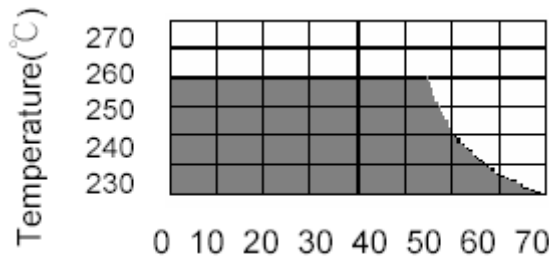

A	Slope of temp. rise	1 to 5	° C/sec
B	Heat time	50 to 150	sec
	Heat temperature	120 to 180	° C
C	Slope of temp. rise	1 to 5	° C/sec
D	Time over 230° C	90 ~ 120	sec
E	Peak temperature	255 ~ 260	° C
	Peak hold time	10 max.	sec
No. of mounting		3	times

(Melting area of solder)

### 8-2. Soldering Iron

Products attachment with soldering iron is discouraged due to the inherent process control limitations. In the event that a soldering iron must be employed the following precautions are recommended.

Note :

- a) Preheat circuit and products to 150° C.
- b) 280° C tip temperature (max)
- c) Use a 30 watt max. soldering iron with tip diameter of 3.0mm
- d) Limit soldering time to 3 secs.

### 8-3. Solder Volume :

Accordingly increasing the solder volume, the mechanical stress to product is also increased. Exceeding solder volume may cause the failure of mechanical or electrical performance. Solder shall be used not to be exceed as shown in right side.

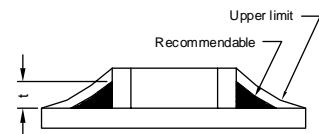

**RoHS Compliant**

NOTE : Specifications subject to change without notice. Please check our website for latest information.

30.01.2015



## 9. PACKAGING INFORMATION :

### 9-1. Paper Carrier Tape Packaging

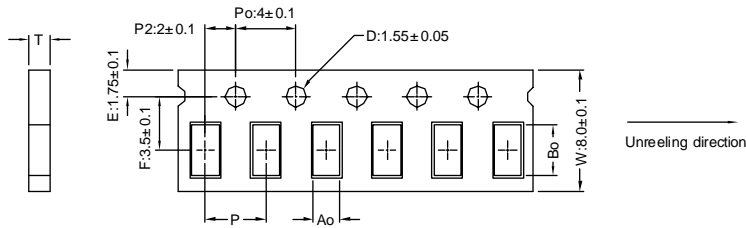

Ao(mm)	Bo(mm)	P(mm)	T(mm)
1.45 ± 0.05	2.25 ± 0.05	4.00 ± 0.10	0.95 ± 0.05

### 9-2. Leader And Trailer Tape

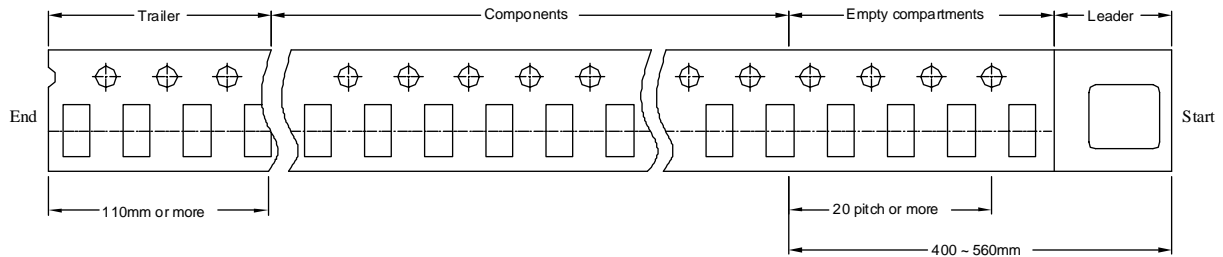

### 9-3. Configuration

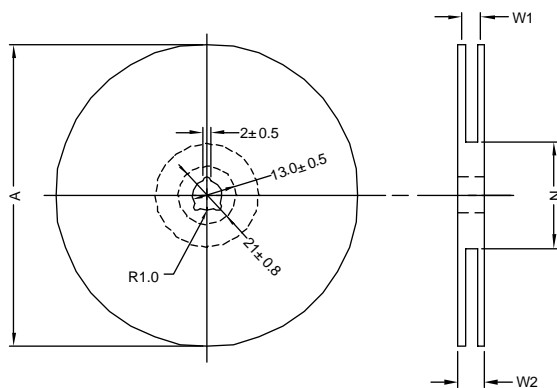

A(mm)	N(mm)	W1(mm)	W2(mm)	QTY (PCS)
178 ± 2.0	50 Min.	10 ± 1.5	20 Max.	4000/Reel



**RoHS Compliant**

NOTE : Specifications subject to change without notice. Please check our website for latest information.



## 9-4. Tearing Off Force

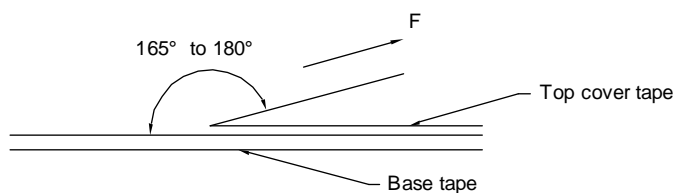

### Peeling Strength of Cover Tape

Cover Tape	10g ~ 100g
------------	------------

Peel Speed : 300mm/min

## 9-5. Packaging

1. Reel and a bag of desiccant shall be packed in Nylon or plastic bag
2. Maximum of 5 bags shall be packed in an inner box
3. Maximum of 6 inner boxes shall be packed in an outer box

## Application Notice

### 1. Storage Conditions :

To maintain the solderability of terminal electrodes :

- a) Recommended products should be used within 12 months from the time of delivery.
- b) The packaging material should be kept where no chlorine or sulfur exists in the air.

### 2. Transportation :

- a) Products should be handled with care to avoid damage or contamination from perspiration and skin oils.
- b) The use of tweezers or vacuum pick up is strongly recommended for individual components.
- c) Bulk handling should ensure that abrasion and mechanical shock are minimized.



**RoHS Compliant**

NOTE : Specifications subject to change without notice. Please check our website for latest information.

30.01.2015



**SUPERWORLD ELECTRONICS (S) PTE LTD**

PG. 6