



SK32BF THRU SK320BF

SURFACE MOUNT SCHOTTKY BARRIER RECTIFIER

Reverse Voltage - 20 to 200 Volts Forward Current - 3.0 Ampere

SMBF

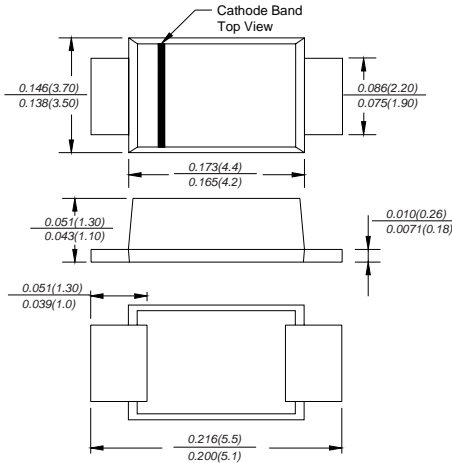

FEATURES

- ◆ Metal silicon junction, majority carrier conduction
- ◆ For surface mounted applications
- ◆ Low power loss, high efficiency
- ◆ High forward surge current capability
- ◆ For use in low voltage, high frequency inverters, free wheeling, and polarity protection applications

MECHANICAL DATA

Case: JEDEC SMBF molded plastic body
Terminals: leads solderable per MIL-STD-750, Method 2026
Mounting Position: Any
Weight: 57mg/0.002oz

MAXIMUM RATINGS AND ELECTRICAL CHARACTERISTICS

Ratings at 25°C ambient temperature unless otherwise specified.
 Single phase half-wave 60Hz, resistive or inductive load, for capacitive load current derate by 20%.

MDD Catalog Number	SYMBOLS	SK32BF	SK34BF	SK36BF	SK38BF	SK310BF	SK315BF	SK320BF	UNITS
Marking code		K32B	K34B	K36B	K38B	K310B	K315B	K320B	
Maximum repetitive peak reverse voltage	V_{RRM}	20	40	60	80	100	150	200	VOLTS
Maximum RMS voltage	V_{RMS}	14	28	42	56	70	105	140	VOLTS
Maximum DC blocking voltage	V_{DC}	20	40	60	80	100	150	200	VOLTS
Maximum average forward rectified current at TL (see fig.1)	$I_{(AV)}$	3.0							Amp
Peak forward surge current 8.3ms single half sine-wave superimposed on rated load (JEDEC Method)	I_{FSM}	80.0			70.0				Amps
Maximum instantaneous forward voltage at 3.0A	V_F	0.55	0.70	0.85		0.95		Volts	
Maximum DC reverse current at rated DC blocking voltage	I_R	0.5 5.0			0.3 3.0		mA		
Typical junction capacitance (NOTE 1)	C_J	450			400				pF
Typical thermal resistance (NOTE 2)	$R_{\theta JA}$	50.0							°C/W
Operating junction temperature range	T_J	-50 to +125							°C
Storage temperature range	T_{STG}	-50 to +150							°C

Note: 1. Measured at 1MHz and applied reverse voltage of 4.0V D.C.
 2. P.C.B. mounted with 0.2x0.2" (5.0x5.0mm) copper pad areas



RATINGS AND CHARACTERISTIC CURVES SK32BF THRU SK320BF

Fig.1 Forward Current Derating Curve

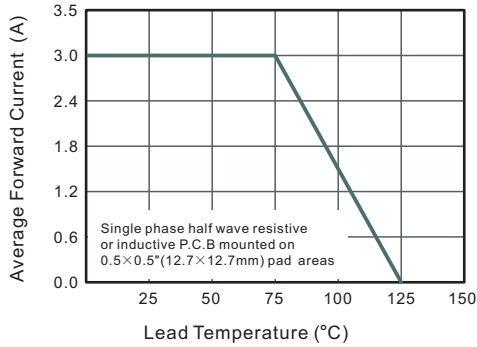

Fig.2 Typical Reverse Characteristics

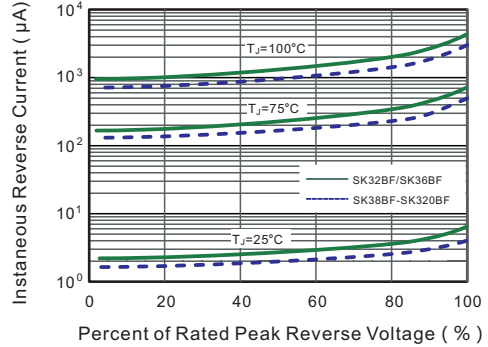

Fig.3 Typical Forward Characteristic

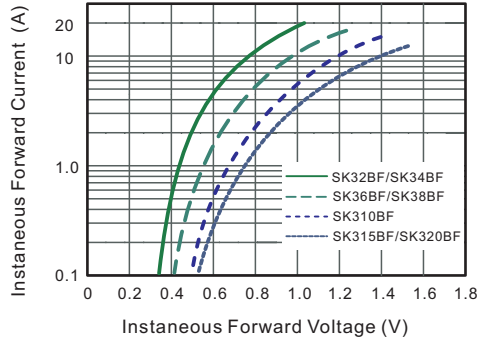

Fig.4 Typical Junction Capacitance

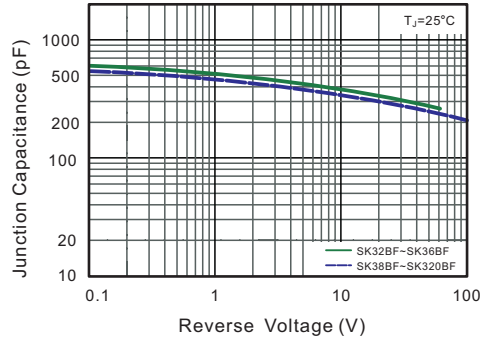

Fig.5 Maximum Non-Repetitive Peak Forward Surge Current

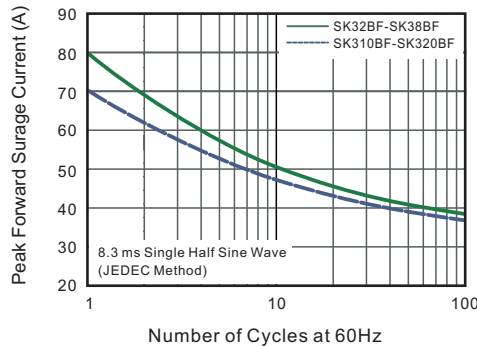
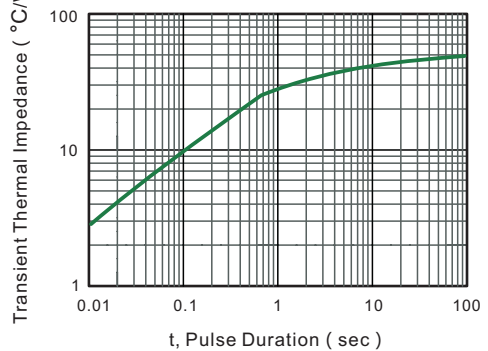

Fig.6- Typical Transient Thermal Impedance



The cruve graph is for reference only, can't be the basis for judgment(曲线图仅供参考)!

