

20A, 60V Trench Schottky Rectifier

FEATURES

- Patented Trench Schottky technology
- Excellent high temperature stability
- Low forward voltage
- Lower power loss/ high efficiency
- High forward surge capability
- Ideal for automated placement
- Compliant to RoHS Directive 2011/65/EU and in accordance to WEEE 2002/96/EC
- Halogen-free according to IEC 61249-2-21 definition

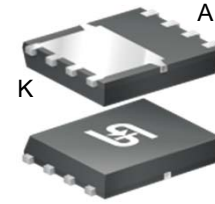

PDFN56

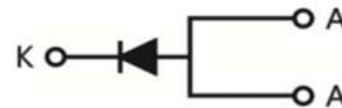

TYPICAL APPLICATIONS

Trench Schottky barrier rectifier are designed for high frequency miniature switched mode power supplies such as adapters, lighting and on-board DC/DC converters.

MECHANICAL DATA

Case: PDFN56

Molding compound meets UL 94 V-0 flammability rating

Packing code with suffix "G" means green compound (halogen-free)

Moisture sensitivity level: level 1, per J-STD-020

Terminal: Matte tin plated leads, solderable per JESD22-B102

Meet JESD 201 class 1A whisker test

Polarity: As marked

Weight: 0.096g (approximately)

MAXIMUM RATINGS AND ELECTRICAL CHARACTERISTICS (T _A = 25°C unless otherwise noted)							
PARAMETER	SYMBOL	TSN520M60			UNIT		
Marking code		520M60					
Maximum repetitive peak reverse voltage	V _{RRM}	60			V		
Maximum DC forward current	I _{F(AV)}	20			A		
Peak forward surge current, 8.3 ms single half sine-wave superimposed on rated load	I _{FSM}	200			A		
Instantaneous forward voltage (Note 1)	V _F	I _F = 10A	T _J = 25°C	MIN	TYP	MAX	V
			T _J = 125°C	-	0.43	-	
		I _F = 20A	T _J = 25°C	-	0.48	0.58	
			T _J = 125°C	-	0.33	-	
Instantaneous reverse current at rated reverse voltage	I _R	T _J = 25°C	-	-	500	μA	
		T _J = 125°C	-	-	100	mA	
Typical thermal resistance	R _{θJL}	7			°C/W		
Operating junction temperature range	T _J	- 55 to +150			°C		
Storage temperature range	T _{STG}	- 55 to +150			°C		

Note 1: Pulse test with pulse width = 300μs, 1% duty cycle

ORDER INFORMATION (EXAMPLE)

TSN520M60 S3G

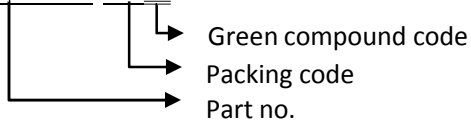

RATINGS AND CHARACTERISTICS CURVES

($T_A = 25^\circ\text{C}$ unless otherwise noted)

FIG.1 FORWARD CURRENT DERATING CURVE

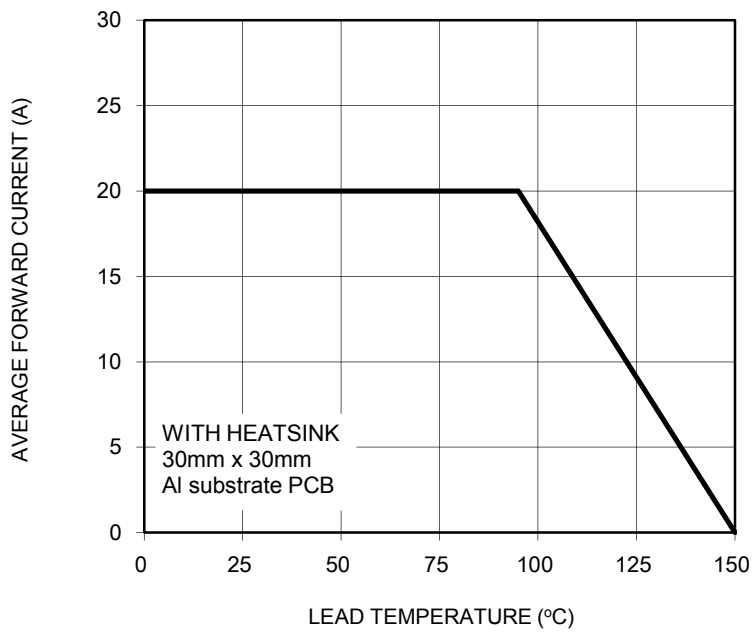

FIG. 2 TYPICAL FORWARD CHARACTERISTICS

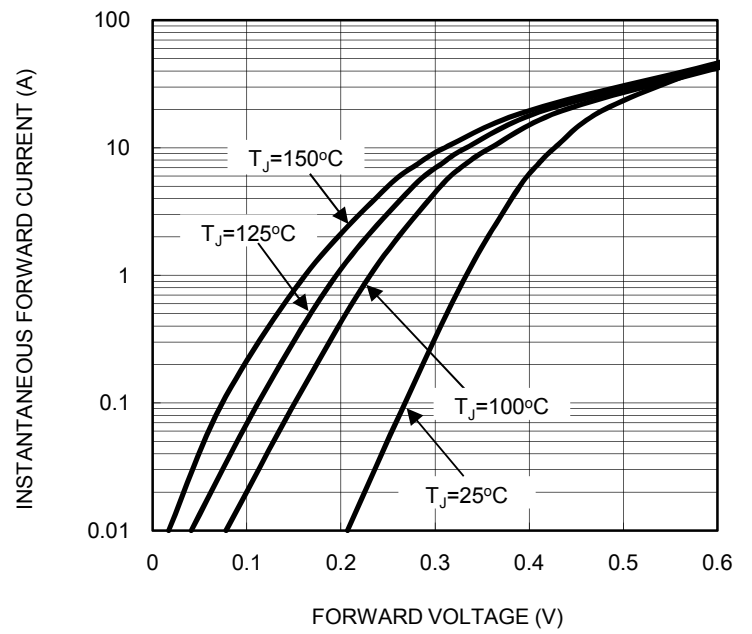

FIG. 3 TYPICAL REVERSE CHARACTERISTICS

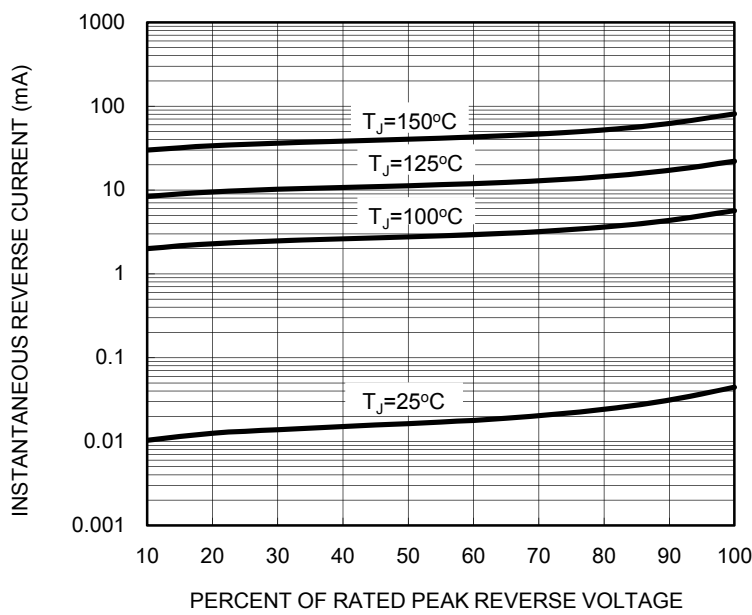
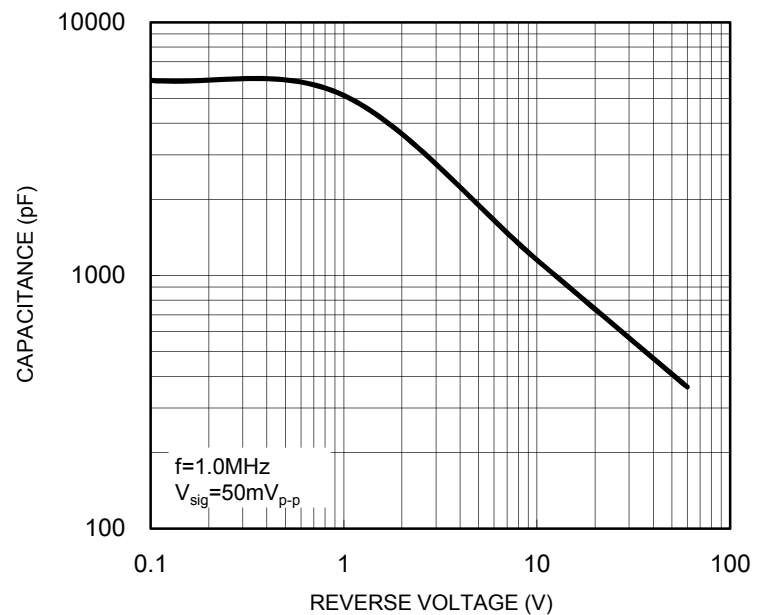
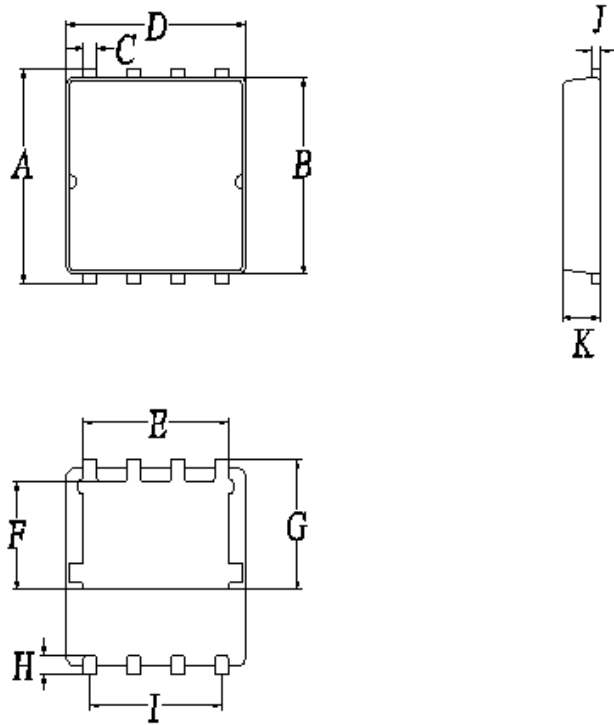

FIG. 4 TYPICAL JUNCTION CAPACITANCE



PACKAGE OUTLINE DIMENSIONS

PDFN56



DIM.	Unit (mm)		Unit (inch)	
	Min	Max	Min	Max
A	6.00	6.40	0.236	0.252
B	5.55	5.85	0.219	0.230
C	0.25	0.55	0.010	0.022
D	5.05	5.35	0.199	0.211
E	4.06	4.36	0.160	0.172
F	3.25	3.55	0.128	0.140
G	3.90	4.20	0.154	0.165
H	0.30	0.60	0.012	0.024
I	3.81 Typ.		0.15 Typ.	
J	0.10	0.40	0.004	0.016
K	0.95	1.25	0.037	0.049

SUGGEST PAD LAYOUT

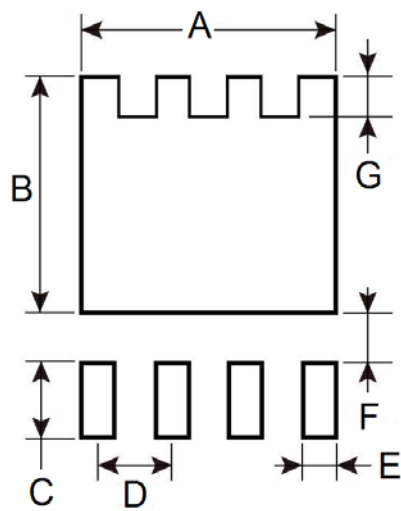

Symbol	Unit (mm)	Unit (inch)
A	4.52	0.178
B	4.52	0.178
C	1.27	0.050
D	1.27	0.050
E	0.60	0.024
F	0.82	0.032
G	0.71	0.028

MARKING DIAGRAM

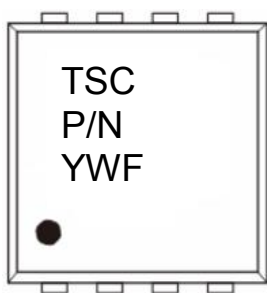

- P/N = Marking Code
- YW = Date Code
- F = Factory Code

Notice

Specifications of the products displayed herein are subject to change without notice. TSC or anyone on its behalf, assumes no responsibility or liability for any errors or inaccuracies.

Information contained herein is intended to provide a product description only. No license, express or implied, to any intellectual property rights is granted by this document. Except as provided in TSC's terms and conditions of sale for such products, TSC assumes no liability whatsoever, and disclaims any express or implied warranty, relating to sale and/or use of TSC products including liability or warranties relating to fitness for a particular purpose, merchantability, or infringement of any patent, copyright, or other intellectual property right.

The products shown herein are not designed for use in medical, life-saving, or life-sustaining applications. Customers using or selling these products for use in such applications do so at their own risk and agree to fully indemnify TSC for any damages resulting from such improper use or sale.