

Small Signal Product

Ultra Low Capacitance ESD Protection Array

FEATURES

- Meet IEC61000-4-2 (ESD) ±15kV (air), ±8kV (contact)
- Meet IEC61000-4-4 (EFT) rating. 40A (5/50ns)
- Meet IEC61000-4-5 (Lightning) rating. 1A (8/20µs)
- Protects two directional I/O lines
- Working voltage: 5V
- Low Capacitance : 0.5 pF typical (I/O to I/O)
- Pb free version and RoHS compliant
- Packing code with suffix "G" means green compound (halogen-free)



2510P10 (DSON10)



MECHANICAL DATA

- Case: 2510P10 (DSON10) standard package, molded plastic
- Terminal: Matte tin plated, lead free., solderable per MIL-STD-202, Method 208 guaranteed
- High temperature soldering guaranteed : 260°C/10s
- Molding compound flammability rating : UL 94V-0
- Weight: 15 ± 0.5 mg
- Marking code : P524

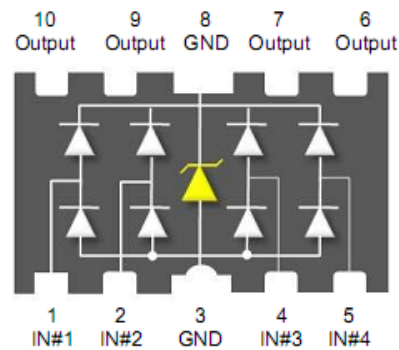

Note: Output line (No internal connection)

APPLICATIONS

- High Definition Multi-Media Interface (HDMI)
- Digital Visual Interface (DVI)
- PCI Express
- Serial ATA
- USB 3.0 Super Speed Interface

MAXIMUM RATINGS AND ELECTRICAL CHARACTERISTICS (T _A =25°C unless otherwise noted)			
PARAMETER	SYMBOL	VALUE	UNIT
Peak Pulse Power (tp=8/20µs waveform)	P _{PP}	150	W
Peak Pulse Current (tp=8/20µs)	I _{PP}	1	A
ESD per IEC 61000-4-2 (Air)	V _{ESD}	± 15	KV
ESD per IEC 61000-4-2 (Contact)		± 8	
Junction and Storage Temperature Range	T _J , T _{STG}	-55 to +150	°C

PARAMETER	SYMBOL	MIN	MAX	UNIT
Reverse Stand-Off Voltage	V _{RWM}	-	5	V
Reverse Breakdown Voltage	V _(BR)	6	-	V
Reverse Leakage Current				
Clamping Voltage	V _C	-	15	V
Junction Capacitance	C _J	1		pF

Small Signal Product

RATINGS AND CHARACTERISTICS CURVES

($T_A=25^\circ\text{C}$ unless otherwise noted)

Fig. 1 Non-Repetitive Peak Pulse Power VS. Pulse Time

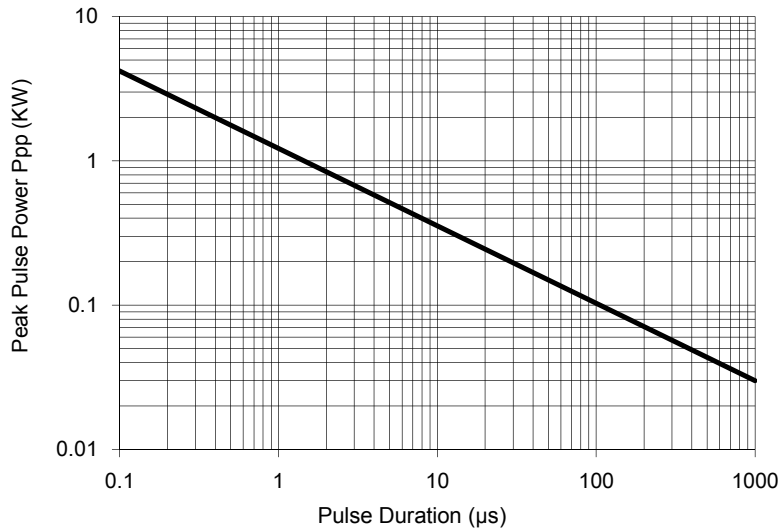

Fig. 2 Pulse Waveform

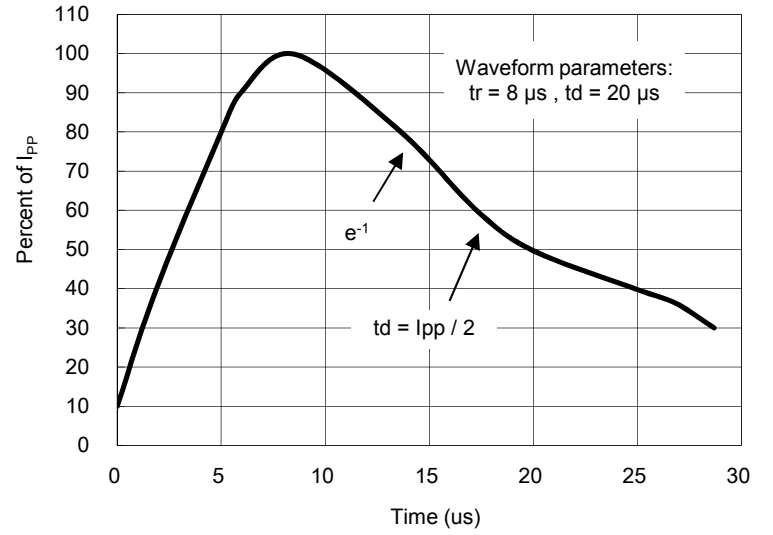

Fig. 3 Admissible Power Dissipation Curve

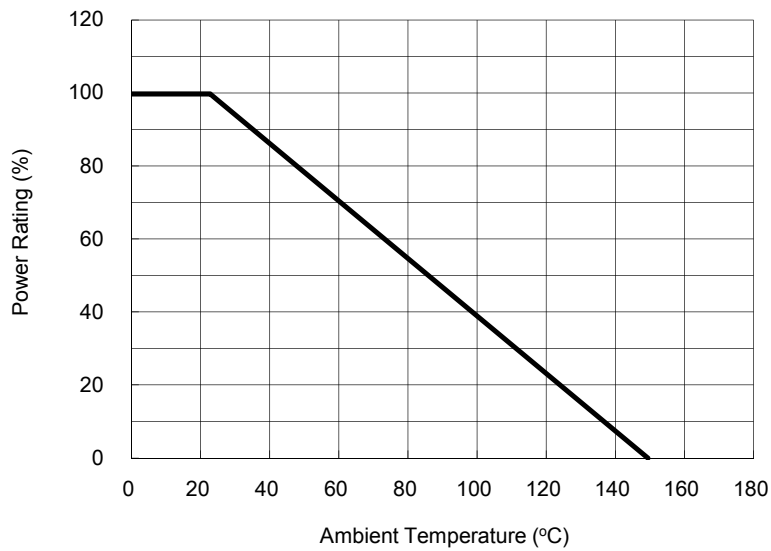

Fig. 4 Typical Junction Capacitance

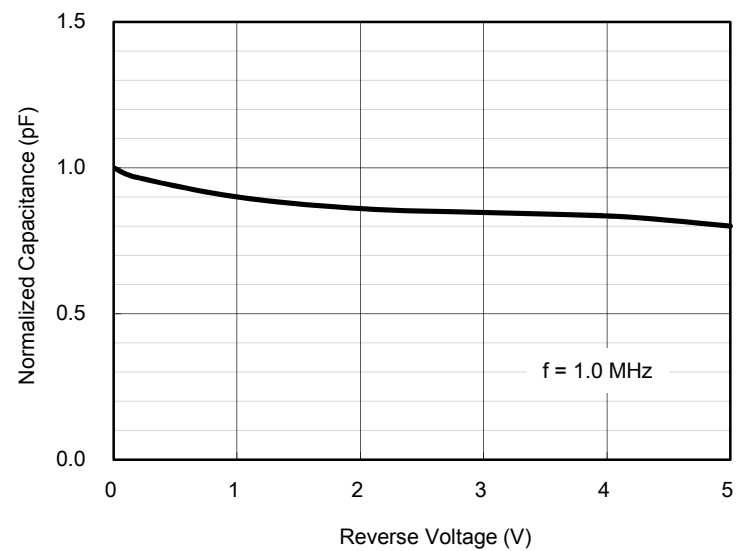

Fig. 5 Clamping Voltage VS. Peak Pulse Current

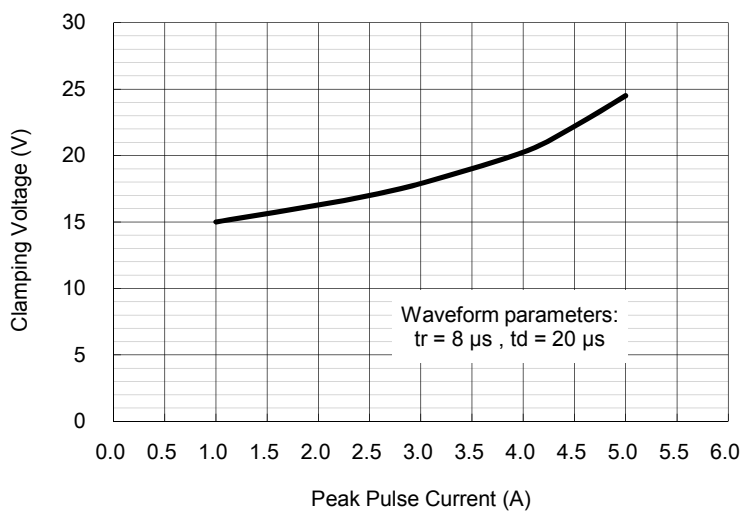
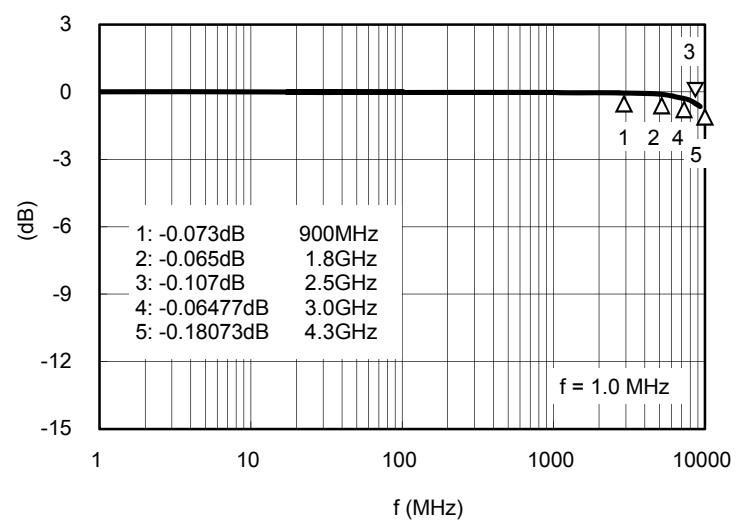

Fig. 6 Insertion Loss



Small Signal Product

ORDER INFORMATION (EXAMPLE)

TESDH5V0A RDG

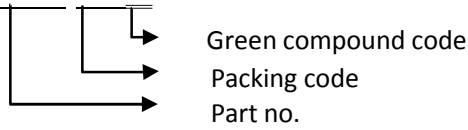

PACKAGE OUTLINE DIMENSIONS
2510P10 (DSON10)

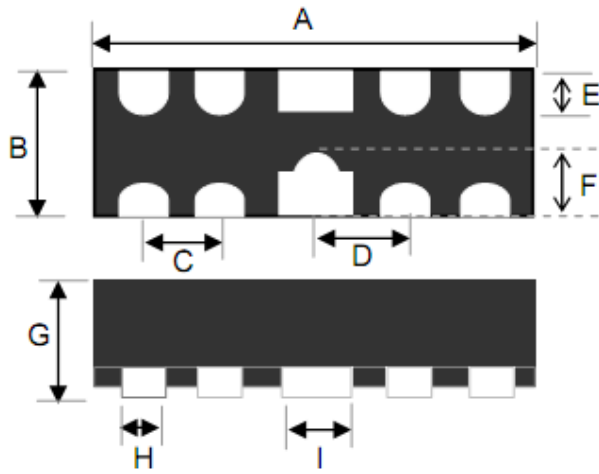

DIM.	Unit (mm)		Unit (inch)	
	Min	Max	Min	Max
A	2.40	2.60	0.094	0.102
B	0.90	1.10	0.035	0.043
C	0.50 REF		0.020 REF	
D	0.63 REF		0.025 REF	
E	0.30	0.43	0.012	0.017
F	0.45	0.55	0.018	0.022
G	0.50	0.65	0.020	0.026
H	0.15	0.25	0.006	0.010
I	0.35	0.45	0.014	0.018

SUGGESTED PAD LAYOUT

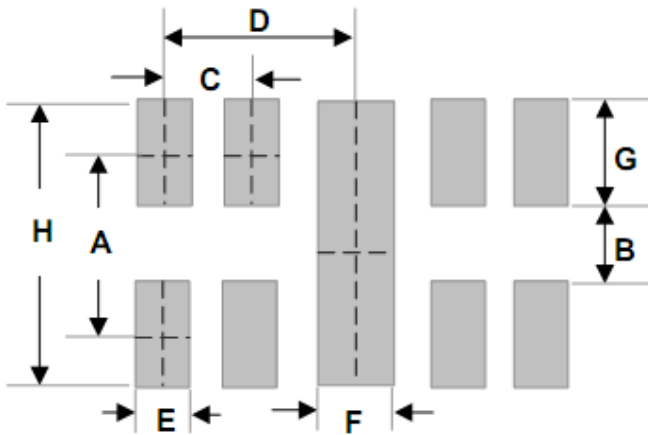

DIM.	Unit (mm)	Unit (inch)
	Typ.	Typ.
A	0.88	0.035
B	0.20	0.008
C	0.50	0.020
D	1.00	0.039
E	0.20	0.008
F	0.40	0.016
G	0.68	0.027
H	1.55	0.061

Note: 1. The suggested land pattern dimensions have been provided for reference only, as actual pad layouts may vary depending on application.

Small Signal Product

APPLICATIONS INFORMATION

- ◇ Designed for protection of high-speed interfaces such as HDMI
- ◇ Ultra low capacitance between the pins while being rated to handle $>\pm 8\text{kV}$ ESD contact discharges and $>\pm 15\text{kV}$ air discharge
- ◇ Each device in a leadless package that is less than 1.1mm wide
- ◇ Designed such that the traces flow straight through the device. The narrow package and flow-through design reduces discontinuities and minimizes impact on signal integrity
- ◇ TESDH5V0A is ultra low capacitance ESD protection array designed to protect high speed data interfaces. This series has been specifically designed to protect sensitive components which are connected to high-speed data and transmission lines from overvoltage caused by ESD, CDE (Cable Discharge Events), and EFT (electrical fast transients)
- ◇ The combination of small size, low capacitance, and high level of ESD protection makes them a flexible solution for applications of high speed interface, ex HDMI, DisplayPort™, MDDI, and eSATA interfaces

CIRCUIT BOARD LAYOUT RECOMMENDATIONS FOR HDMI APPLICATION

- ◇ The PCB traces are used to connect the pin pairs for each line (pin 1 to pin 10, pin 2 to pin 9, pin 4 to pin 7, pin 5 to pin 6)
- ◇ Signal line enters at pin 1 and exits at pin 10 and the PCB trace connects pin 1 and 10 together. Ground is connected at pin 3 and 8.
- ◇ One large ground pad should be used in lieu of two separate pads

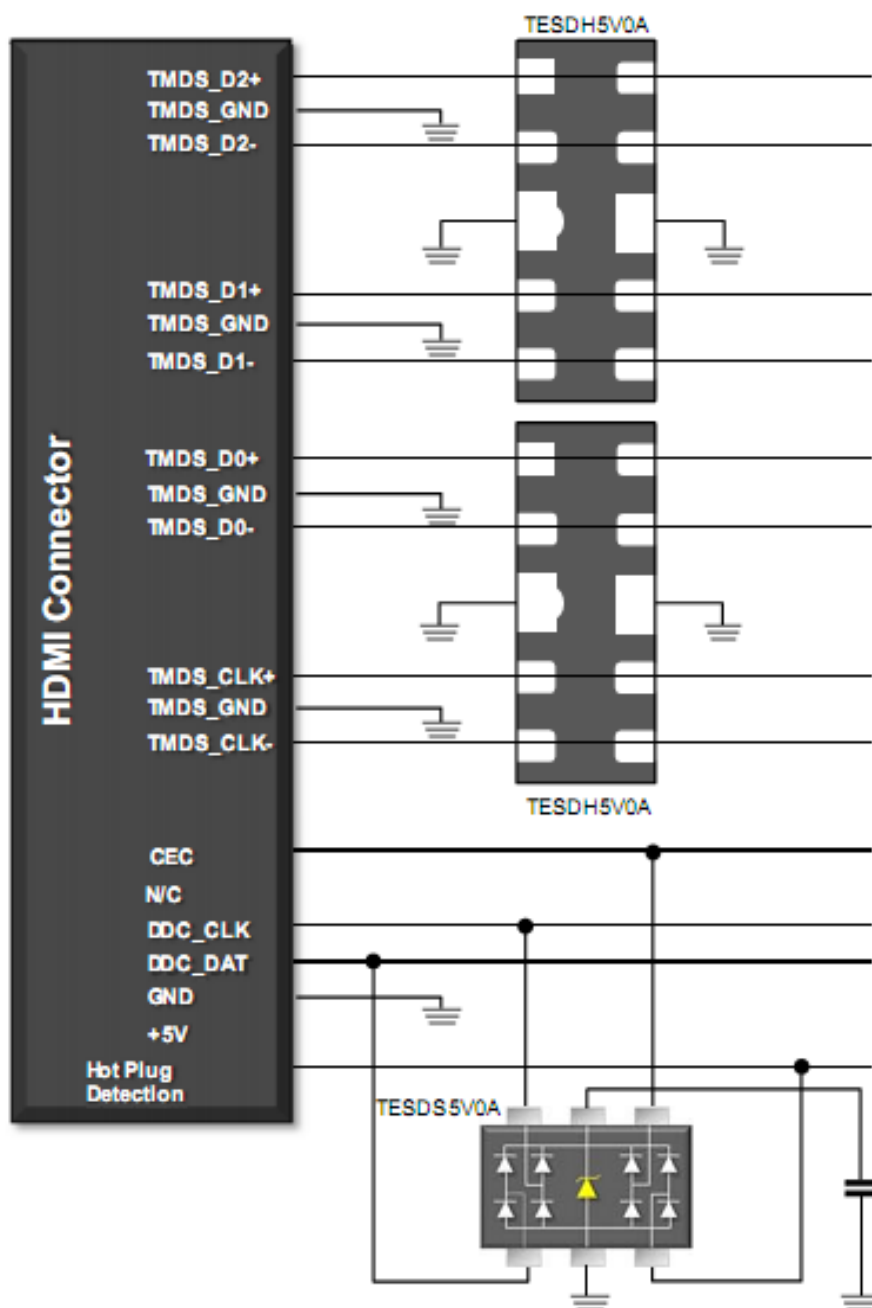

Notice

Specifications of the products displayed herein are subject to change without notice. TSC or anyone on its behalf, assumes no responsibility or liability for any errors or inaccuracies.

Information contained herein is intended to provide a product description only. No license, express or implied, to any intellectual property rights is granted by this document. Except as provided in TSC's terms and conditions of sale for such products, TSC assumes no liability whatsoever, and disclaims any express or implied warranty, relating to sale and/or use of TSC products including liability or warranties relating to fitness for a particular purpose, merchantability, or infringement of any patent, copyright, or other intellectual property right.

The products shown herein are not designed for use in medical, life-saving, or life-sustaining applications. Customers using or selling these products for use in such applications do so at their own risk and agree to fully indemnify TSC for any damages resulting from such improper use or sale.