

1. PART NO. EXPRESSION :

C 2 - 1 N 0 S - □ □
 (a) (b) (c) (d)

(a) Series code

(b) Inductance code : 1N0 = 1.0nH

(c) Tolerance code : S = ±0.3nH, J = ±5%

(d) 10: Standard

11 ~ 99 : Internal control number

2. CONFIGURATION & DIMENSIONS :

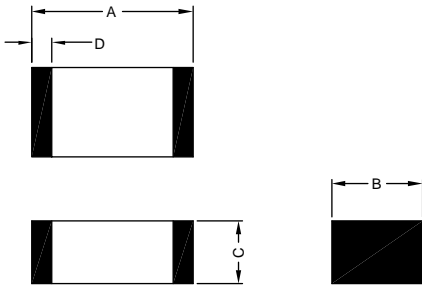

Unit:m/m

A	B	C	D
1.6±0.15	0.8±0.15	0.8±0.15	0.2 ~ 0.6

3. SCHEMATIC :

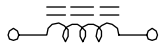

4. MATERIALS :

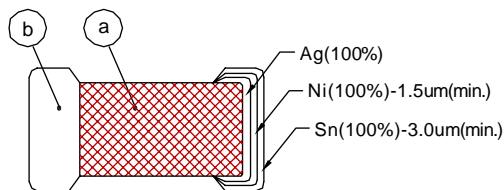

(a) Body : ceramic (Pb Free)

(b) Termination : (Pb Free)

5. GENERAL SPECIFICATION :

- a) Operating temp. : -40° C to +85° C
- b) Storage condition (component in its packaging)
 - i) Temperature : -10 to 40° C
 - ii) Humidity : 60%



RoHS Compliant

NOTE : Specifications subject to change without notice. Please check our website for latest information.

30.01.2015



SUPERWORLD ELECTRONICS (S) PTE LTD

6. ELECTRICAL CHARACTERISTICS :

Part Number	Inductance (nH)	Q Min.	Test Frequency (MHz)	SRF (GHz) Min.	DCR (Ω) Max.	Rated Current (mA) Max.
	AT 100MHz 250mV					
C2-1N0S-10	1.0	8	100	10	0.05	300
C2-1N2S-10	1.2	8	100	10	0.05	300
C2-1N5S-10	1.5	8	100	6	0.10	300
C2-1N8S-10	1.8	8	100	6	0.10	300
C2-2N2S-10	2.2	8	100	6	0.10	300
C2-2N7S-10	2.7	10	100	6	0.10	300
C2-3N3S-10	3.3	10	100	6	0.12	300
C2-3N9S-10	3.9	10	100	6	0.14	300
C2-4N7S-10	4.7	10	100	4	0.16	300
C2-5N6S-10	5.6	10	100	4	0.18	300
C2-6N8J-10	6.8	10	100	4	0.22	300
C2-8N2J-10	8.2	10	100	3.5	0.24	300
C2-10NJ-10	10	12	100	3.4	0.26	300
C2-12NJ-10	12	12	100	2.6	0.28	300
C2-15NJ-10	15	12	100	2.3	0.32	300
C2-18NJ-10	18	12	100	2.0	0.35	300
C2-22NJ-10	22	12	100	1.6	0.40	300
C2-27NJ-10	27	12	100	1.4	0.45	300
C2-33NJ-10	33	12	100	1.2	0.55	300
C2-39NJ-10	39	12	100	1.1	0.60	300
C2-47NJ-10	47	12	100	0.9	0.70	300
C2-56NJ-10	56	12	100	0.9	0.75	300
C2-68NJ-10	68	12	100	0.7	0.85	300
C2-82NJ-10	82	12	100	0.6	0.95	300
C2-R10J-10	100	12	100	0.6	1.00	300
C2-R12J-10	120	8	50	0.5	1.20	300
C2-R15J-10	150	8	50	0.5	1.20	300
C2-R18J-10	180	8	50	0.4	1.30	300
C2-R22J-10	220	8	50	0.4	1.50	300

Tolerance code :

S : ± 0.3nH

J : ± 5%



RoHS Compliant

NOTE : Specifications subject to change without notice. Please check our website for latest information.

30.01.2015



SUPERWORLD ELECTRONICS (S) PTE LTD

PG. 2

7. CHARACTERISTICS CURVES :

INDUCTANCE VS FREQUENCY CHARACTERISTICS

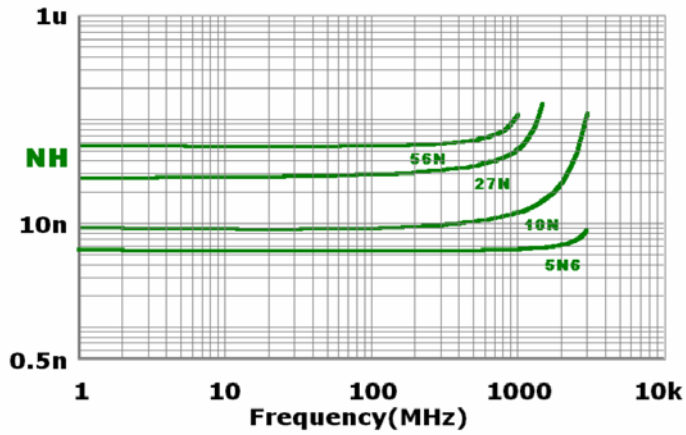

Q VS FREQUENCY CHARACTERISTICS

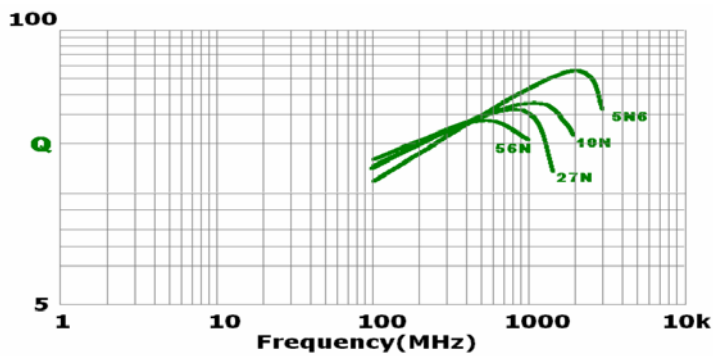

NOTE : Specifications subject to change without notice. Please check our website for latest information.



RoHS Compliant

30.01.2015



SUPERWORLD ELECTRONICS (S) PTE LTD

8. SOLDERING AND MOUNTING :

8-1. Reflow soldering conditions

- Pre—heating should be in such a way that the temperature difference between solder and ferrite surface is limited to 150° C max. Also cooling into solvent after soldering should be in such a way that the temperature difference is limited to 100° C max. Unenough pre—heating may cause cracks on the ferrite, resulting in the deterioration of product quality.
- Products should be soldered within the following allowable range indicated by the slanted line. The excessive soldering conditions may cause the corrosion of the electrode, When soldering is repeated, allowable time is the accumulated time.

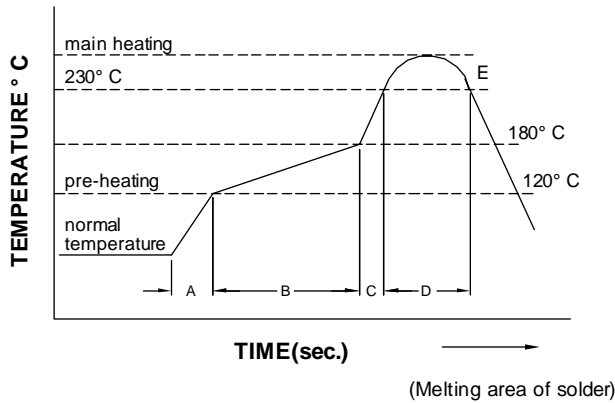
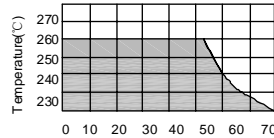

A	Slope of temp. rise	1 to 5	° C/sec
B	Heat time	50 to 150	sec
	Heat temperature	120 to 180	° C
C	Slope of temp. rise	1 to 5	° C/sec
D	Time over 230° C	90~120	sec
E	Peak temperature	255~260	° C
	Peak hold time	10 max.	sec
No. of mounting		3	times

8-2. Reworking with soldering iron

Preheating	150° C, 1 minute
Tip temperature	280° C max
Soldering time	3seconds max.
Soldering iron output	30w max.
End of soldering iron	Ø3mm max.

- Reworking should be limited to only one time.

Note: Do not directly touch the products with the tip of the soldering iron in order to prevent the crack on the ferrite material due to the thermal shock.



RoHS Compliant

NOTE : Specifications subject to change without notice. Please check our website for latest information.

30.01.2015



SUPERWORLD ELECTRONICS (S) PTE LTD

8-3. Solder Volume

Accordingly increasing the solder volume, the mechanical stress to product is also increased. Exceeding solder volume may cause the failure of mechanical or electrical performance. Solder shall be used not to be exceed as shown in Fig. 1.

Minimum fillet height = soldering thickness + 25% product height

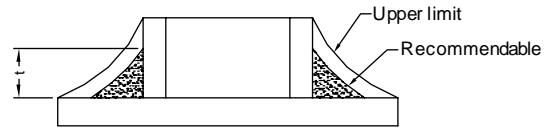

Figure 1



RoHS Compliant

NOTE : Specifications subject to change without notice. Please check our website for latest information.

30.01.2015



SUPERWORLD ELECTRONICS (S) PTE LTD

PG. 6

9. PACKAGING INFORMATION :

9-1. Reel Dimension Unit:m/m

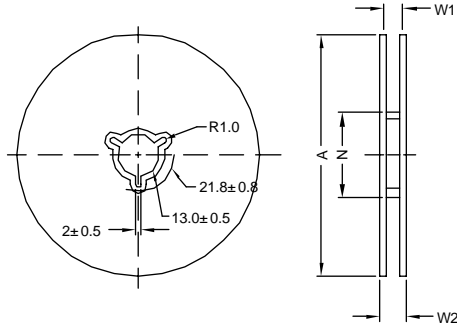

A(mm)	N(mm)	W1(mm)	W2(mm)
178± 2.0	50 Min.	10± 1.5	20 Max.

9-2. Tape Dimension

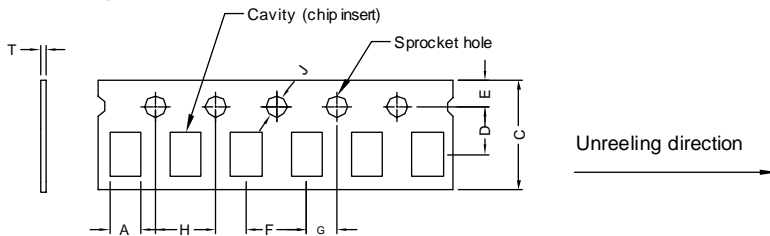

Series	A(mm)	B(mm)	C(mm)	D(mm)	E(mm)	F(mm)	G(mm)	H(mm)	J(mm)	T(mm)
C2	1.03± 0.05	1.85± 0.05	8.00± 0.10	3.50± 0.05	1.75± 0.10	4.00± 0.10	2.00± 0.05	4.00± 0.10	1.55± 0.05	0.95± 0.05

9-3. Packaging Quantity

Chip size	C2
Reel	4000 Pcs

9-4. Leader / Trailer Tape

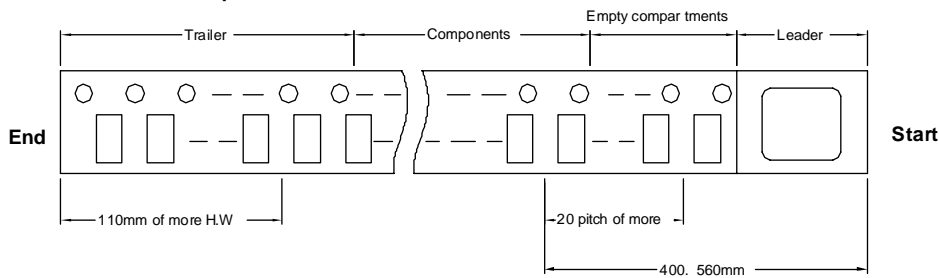

RoHS Compliant

NOTE : Specifications subject to change without notice. Please check our website for latest information.

30.01.2015



SUPERWORLD ELECTRONICS (S) PTE LTD

PG. 7

9-5. Tearing Off Force

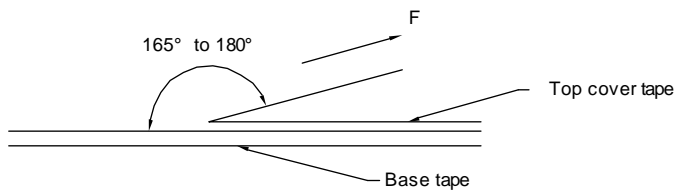

Peeling Strength of Cover Tape

Carrier Tape	10g ~ 100g
--------------	------------

peel angle: 165°~180° vs carrier tape

Peel Speed : 300mm/min

9-6. Packaging

1. Reel and a bag of desiccant shall be packed in Nylon or plastic bag
2. Maximum of 5 bags shall be packed in an inner box
3. Maximum of 6 inner boxes shall be packed in an outer box

Application Notice

1. Storage Conditions :

To maintain the solderability of terminal electrodes :

- a) Recommended products should be used within 12 months from the time of delivery.
- b) The packaging material should be kept where no chlorine or sulfur exists in the air.

2. Transportation :

- a) Products should be handled with care to avoid damage or contamination from perspiration and skin oils.
- b) The use of tweezers or vacuum pick up is strongly recommended for individual components.
- c) Bulk handling should ensure that abrasion and mechanical shock are minimized.



RoHS Compliant

NOTE : Specifications subject to change without notice. Please check our website for latest information.

30.01.2015



SUPERWORLD ELECTRONICS (S) PTE LTD

PG. 8