

## LOW DROP FIXED AND ADJUSTABLE POSITIVE VOLTAGE REGULATOR

The KIA1117BS/BF/BPI×× Series are a Low Drop Voltage Regulator able to provide up to 1A of output current, available even in adjustable version (Vref=1.25V)

### FEATURES

- Low Dropout Voltage : 1.1V/Typ. (Iout=1.0A)
- Very Low Quiescent Current : 5mA(Typ)
- Output Current up to 1A
- Fixed Output Voltage of 1.2V, 1.5V, 1.8V, 2.5V, 3.3V, 5.0V
- Adjustable Version Availability : Vref=1.25V
- Internal Current and Thermal Limit
- A Minimum of 10μF for stability
- Suitable for MLCC, Tantalum and Low ESR Electrolytic Capacitors
- ESR Range for stability : 1mΩ ~200Ω
- Available in ± 2%(at 25℃)
- High Ripple Rejection : 80dB(Typ)
- Temperature Range : -40℃ ~ 150℃

### LINE UP

ITEM	OUTPUT VOLTAGE (V)	PACKAGE
KIA1117BS/BF/BPI00	Adjustable (1.25~10V)	BS : SOT-223 BF : DPAK BPI : TO-220IS
KIA1117BS/BF/BPI12	1.2	
KIA1117BS/BF/BPI15	1.5	
KIA1117BS/BF/BPI18	1.8	
KIA1117BS/BF/BPI25	2.5	
KIA1117BS/BF/BPI33	3.3	
KIA1117BS/BF/BPI50	5.0	

### MAXIMUM RATINGS (Ta=25℃)

CHARACTERISTIC	SYMBOL	RATING	UNIT
Input Voltage	V <sub>IN</sub>	15	V
Output Current	I <sub>OUT</sub>	1.0	A
Power Dissipation 1 (No Heatsink)	S (Note)	1.0	W
	F	1.3	
	PI	2.0	
Power Dissipation 2 (Infinite Heatsink)	S	8.3	W
	F	13	
	PI	20.8	
Maximum Junction Temperature	T <sub>j(max)</sub>	150	℃
Operating Junction Temperature	T <sub>opr</sub>	-40 ~ 150	℃
Storage Temperature	T <sub>stg</sub>	-55 ~ 150	℃

Note) Package Mounted on FR-4 PCB 36mm×18mm×1.5mm.  
: mounting pad for the GND Lead min. 6cm<sup>2</sup>

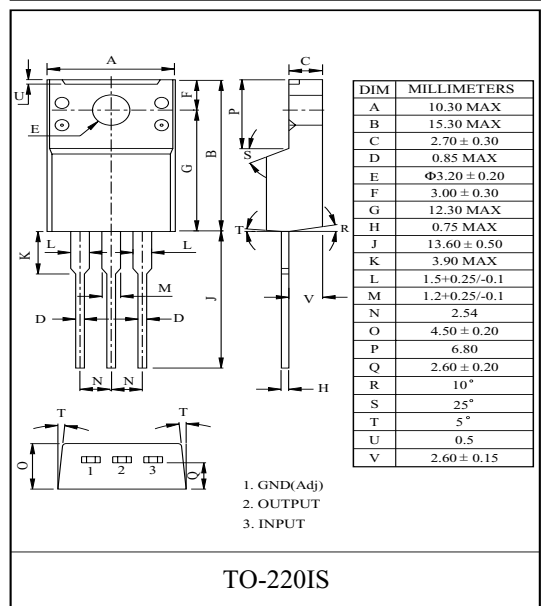
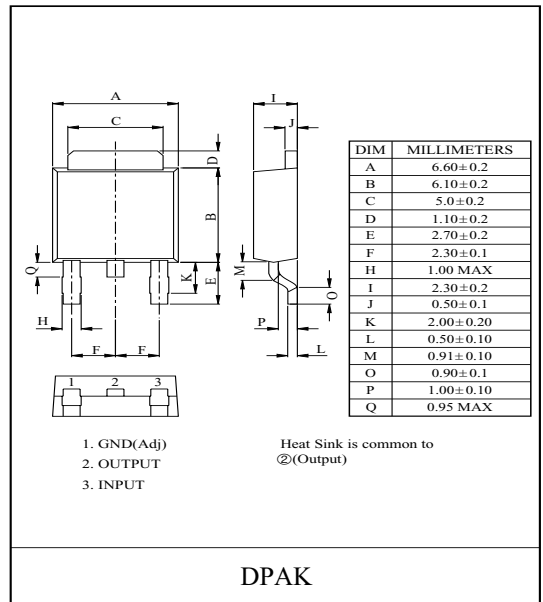
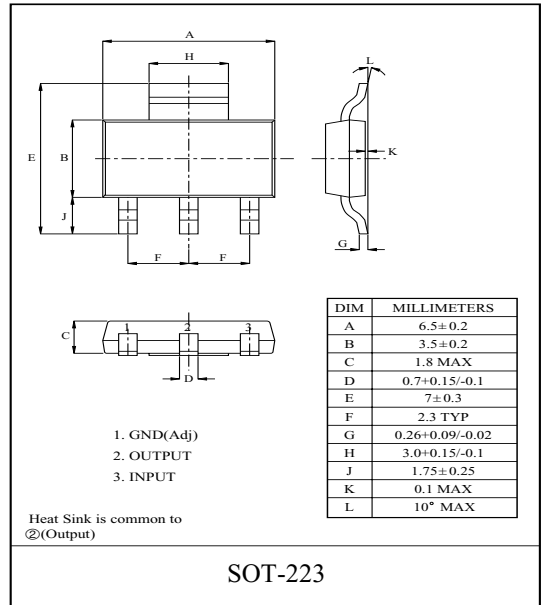

# KIA1117BS/BF/BPI00 ~ KIA1117BS/BF/BPI50

## ELECTRICAL CHARACTERISTICS

Unless otherwise specified,  $T_j=25^\circ\text{C}$

CHARACTERISTIC	ITEM	SYMBOL	TEST CONDITIONS	MIN.	TYP.	MAX.	UNIT	
Reference Voltage	KIA1117-Adj	$V_{REF1}$	$V_{IN}=V_{OUT}+1.5V, I_{OUT}=10mA$	1.225	1.25	1.275	V	
		$V_{REF2}$	$10mA \leq I_{OUT} \leq 1A, V_{OUT}+1.5V \leq V_{IN} \leq 10V$	1.213	1.25	1.288	V	
Output Voltage	KIA1117-12	$V_{OUT1}$	$V_{IN}=2.7V, I_{OUT}=10mA$	1.176	1.2	1.224	V	
		$V_{OUT2}$	$10mA \leq I_{OUT} \leq 1A, 2.7V \leq V_{IN} \leq 10V$	1.164	1.2	1.236	V	
	KIA1117-15	$V_{OUT1}$	$V_{IN}=3.0V, I_{OUT}=10mA$	1.470	1.5	1.530	V	
		$V_{OUT2}$	$10mA \leq I_{OUT} \leq 1A, 3.0V \leq V_{IN} \leq 10V$	1.460	1.5	1.540	V	
	KIA1117-18	$V_{OUT1}$	$V_{IN}=3.3V, I_{OUT}=10mA$	1.764	1.8	1.836	V	
		$V_{OUT2}$	$10mA \leq I_{OUT} \leq 1A, 3.3V \leq V_{IN} \leq 10V$	1.754	1.8	1.846	V	
	KIA1117-25	$V_{OUT1}$	$V_{IN}=4.0V, I_{OUT}=10mA$	2.450	2.5	2.550	V	
		$V_{OUT2}$	$10mA \leq I_{OUT} \leq 1A, 4.0V \leq V_{IN} \leq 10V$	2.440	2.5	2.560	V	
	KIA1117-33	$V_{OUT1}$	$V_{IN}=4.8V, I_{OUT}=10mA$	3.234	3.3	3.366	V	
		$V_{OUT2}$	$10mA \leq I_{OUT} \leq 1A, 4.8V \leq V_{IN} \leq 10V$	3.201	3.3	3.399	V	
	KIA1117-50	$V_{OUT1}$	$V_{IN}=6.5V, I_{OUT}=10mA$	4.900	5.0	5.100	V	
		$V_{OUT2}$	$10mA \leq I_{OUT} \leq 1A, 6.5V \leq V_{IN} \leq 10V$	4.850	5.0	5.150	V	
	Line Regulation	-	Reg Line	$V_{OUT}+1.5V \leq V_{IN} \leq 10V, I_{OUT}=10mA$	-	1	10	mV
	Load Regulation	-	Reg Load	$10mA \leq I_{OUT} \leq 1A, V_{IN}=V_{OUT}+2.0V$	-	0.5	1	%
Adjustable Pin Current	KIA1117-Adj	$I_{ADJ}$	$V_{IN}=V_{OUT}+1.5V$	-	35	-	$\mu\text{A}$	
Minimum Load Current	KIA1117-Adj	$I_{MIN}$	$V_{IN}=V_{OUT}+1.5V$	10	-	-	mA	
Quiescent Current	-	$I_{B1}$	$V_{IN}=V_{OUT}+1.25V, I_{OUT}=0A$	-	5	10	mA	
		$I_{B2}$	$V_{IN}=10V, I_{OUT}=0A$	-	5	10		
Output Noise Voltage	-	$V_{NO}$	$V_{IN}=V_{OUT}+1.25V, I_{OUT}=40mA,$ $10Hz \leq f \leq 10kHz$	-	100	-	$\mu\text{Vrms}$	
Short Circuit Current Limit	-	$I_{SC}$	$V_{IN}=V_{OUT}+2.0V$	1.1	-	-	A	
Ripple Rejection	-	$R_{\square R}$	$I_{OUT}=40mA, f=120Hz, V_{ripple}=1Vp-p$ $V_{IN}=V_{OUT}+3V$	60	80	-	dB	
Dropout Voltage	-	$V_D$	$I_{OUT}=1A$	-	1.1	1.4	V	
Temperature Stability	-	$TCV_O$	$V_{IN}=V_{OUT}+1.5V, I_{OUT}=10mA, T_j=-40\sim 150^\circ\text{C}$	-	0.5	-	%	

# KIA1117BS/BF/BPI00 ~ KIA1117BS/BF/BPI50

**Fig.1 Application Circuit-1 (Fixed-Type)**

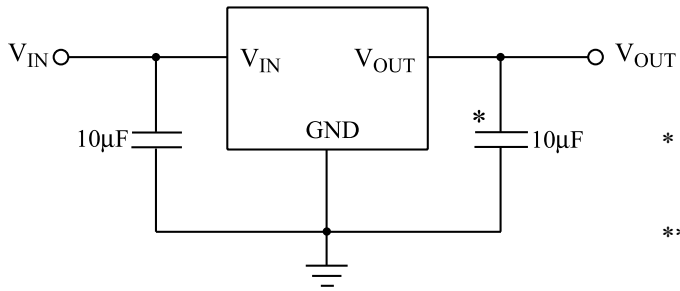

\* Note 1) MLCC, Tantalum, Low ESR Electrolytic Capacitors are suitable in ESR range for stability (1m~200Ω )

\*\* Note 2) When R1 is much larger than 124Ω , apply 8~10mA to Vout-GND by setting an additional dummy resistor for stability of Vout under no load condition

**Fig.2 Application Circuit-2 (Adjustable-Type)**

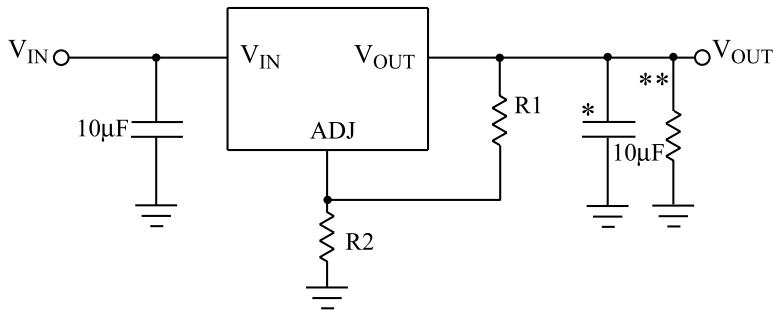

$$V_{OUT} = V_{REF} \times (1 + R2/R1) + I_{ADJ} \times R2$$

# KIA1117BS/BF/BPI00 ~ KIA1117BS/BF/BPI50

Fig. 3  $V_D - I_{OUT}$

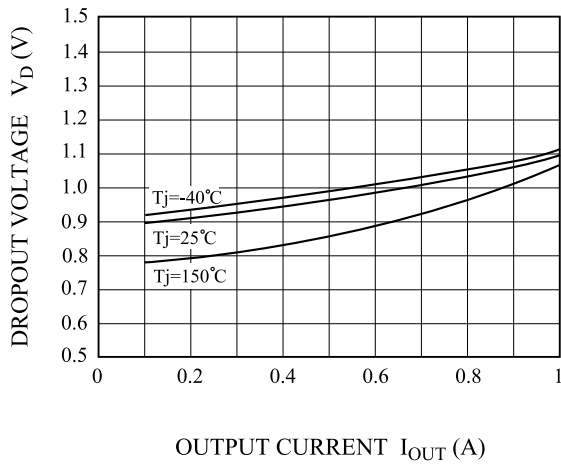

Fig. 4  $V_{OUT}(\text{CHANGE}) - T_j$

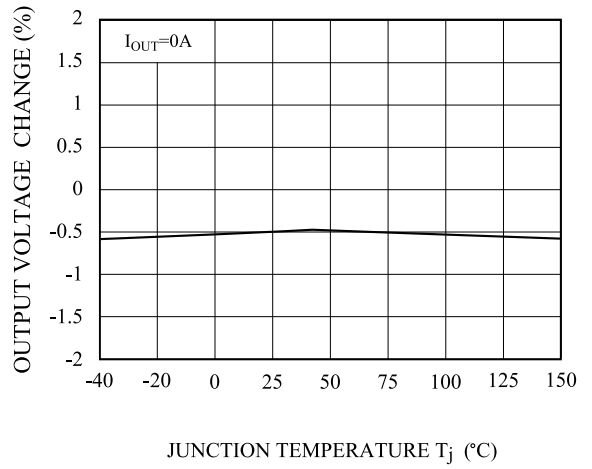

Fig. 5 LINE REGULATION

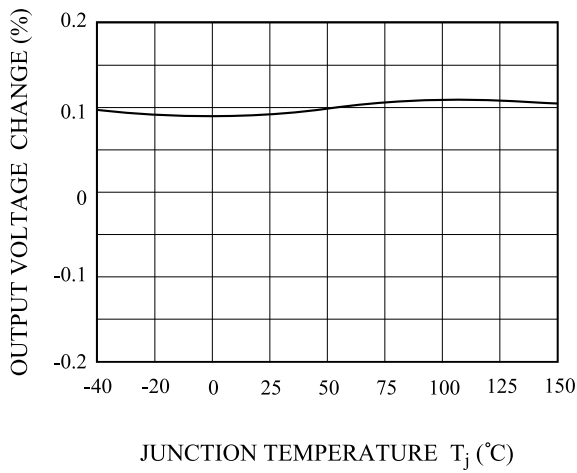

Fig. 6 LOAD REGULATION

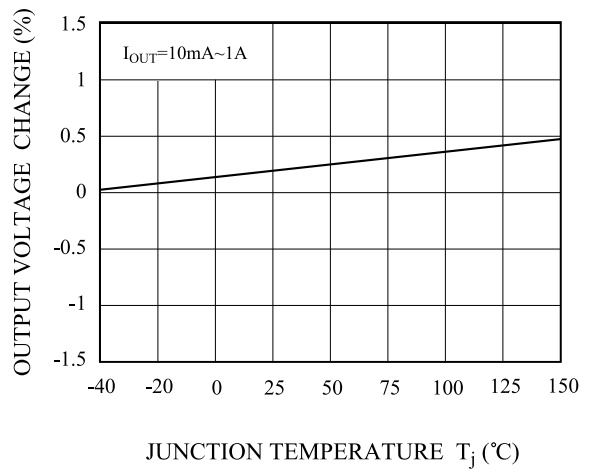

Fig.7  $I_Q - T_j$

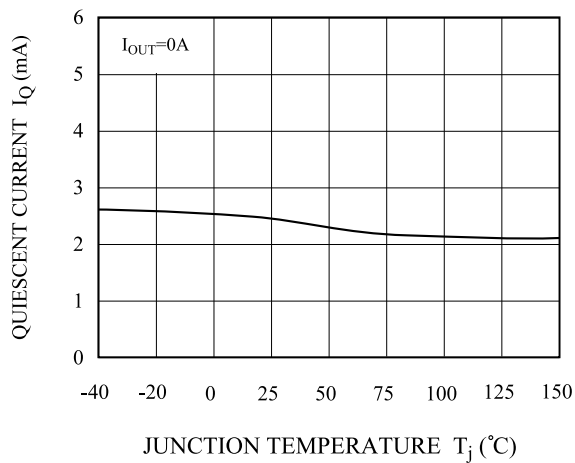
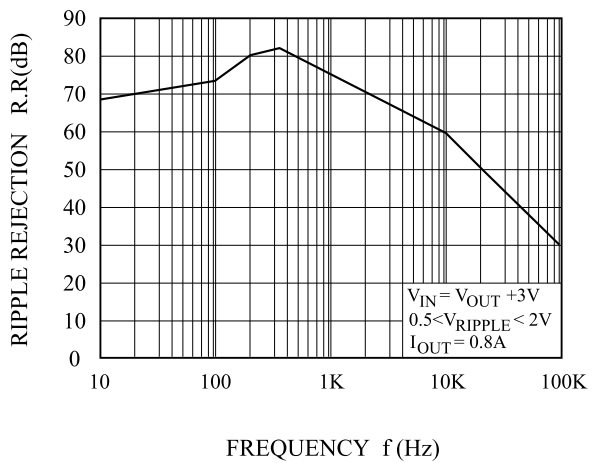

Fig.8 R.R - f



# KIA1117BS/BF/BPI00 ~ KIA1117BS/BF/BPI50

Fig.9  $P_D$  -  $T_a$  (S-Type : SOT-223)

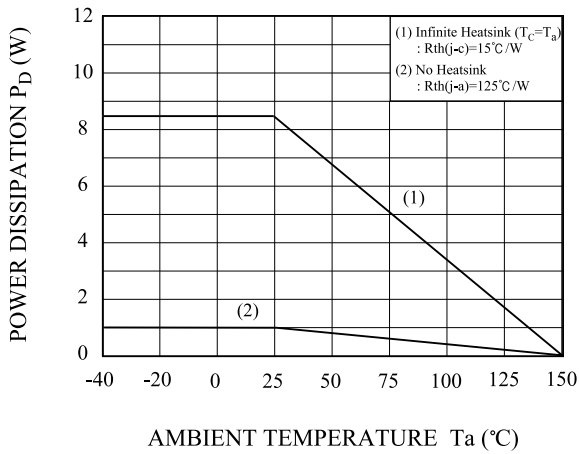

Fig.10  $P_D$  -  $T_a$  (F-Type : DPAK)

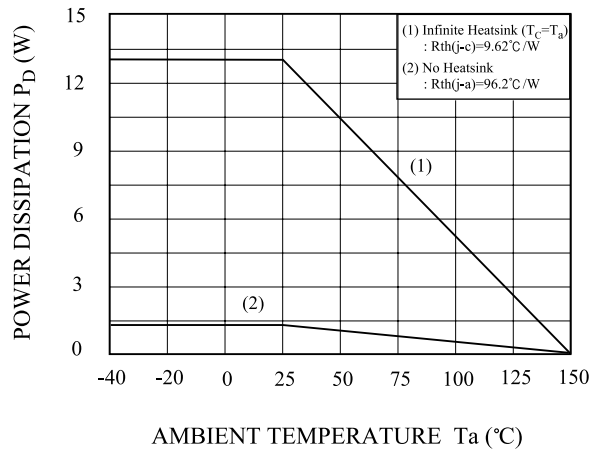

Fig. 11  $P_D$  -  $T_a$  (API-Type : TO-220IS)

