

**SPI-236-17**

Ultraminiature photointerrupter (single-transistor type)

Features

- GaAs Infrared LED plus Single Phototransistor
- Photo-Interrupter
- Contact type
- Compact type : H3.25 × L5.0 × W4.5mm
- Application : For the general public welfare

Absolute Maximum Ratings at Ta=25°C, 65%RH (as per JIS C 7032)

Parameter		Symbol	Rating	Unit
Input LED	Forward Current *1	I _F	50	mA
	Reverse Voltage	V _R	5	V
	Power Dissipation	P _D	70	mW
Output Phototransistor	Collector-Emitter Voltage	V _{CEO}	20	V
	Emitter-Collector Voltage	V _{ECO}	5	V
	Collector Curren	I _C	20	mA
	Power Dissipation	P _C	70	mW
Operating Temperature		T _{opr}	-20 to +80	°C
Storage Temperature		T _{stg}	-30 to +85	°C
Soldering Temperature *2		T _{sol}	260	°C

*1 See forward current derating

*2 Soldering conditions : time : max. 3sec; clearance : min. 1mm from lower stay

Electro-Optical Characteristics at Ta=25°C, 65%RH

Parameter		Symbol	Condition	Min.	Typ.	Max.	Unit
Input	Forward Voltage	V _F	I _F =10mA	1.0	1.15	1.4	V
	Reverse Current	I _R	V _R =5V	-	-	10	μA
Output	Dark Current	I _{CEO}	I _F =0mA, V _{CE} =10V	-	10	200	nA
Coupled	Collector Output Current	I _C	I _F =10mA, V _{CE} =5V*1	240	500	880	μA
	Collector Emitter Saturation Voltage	V _{CE(sat)}	I _F =10mA, I _C =50μA	-	-	0.5	V
	Rise Time	t _r	V _{CC} =5V, R _L =100Ω	-	5	-	μs
	Fall Time	t _f	I _C =1mA	-	5	-	μs

*1 Measurement Circuit of Collector Current

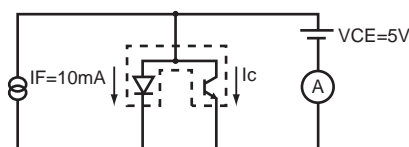

*2 Table of Classification of Collector Output

Class	A	B	C
I _C (μA)	880 to 460	635 to 330	460 to 240

SANYO Electric Co.,Ltd. Semiconductor Company

TOKYO OFFICE Tokyo Bldg., 1-10, 1 Chome, Ueno, Taito-ku, TOKYO, 110-8534 JAPAN

Typical Characteristics



These numerical value show the electrical and optical characteristics of this product, and not assure this contents.

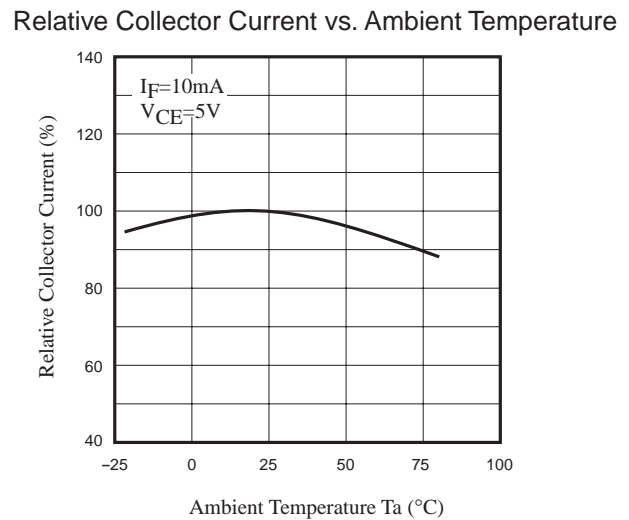
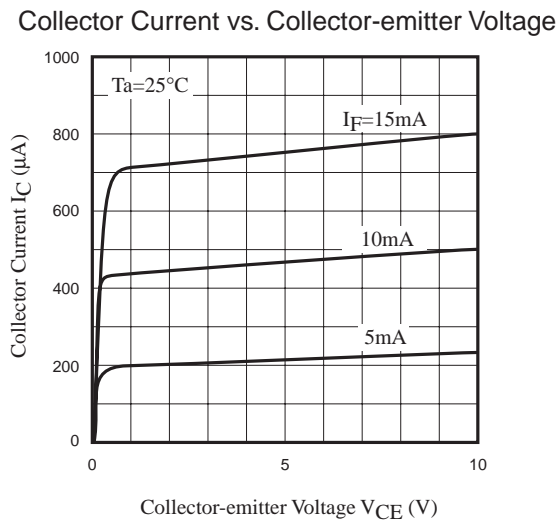
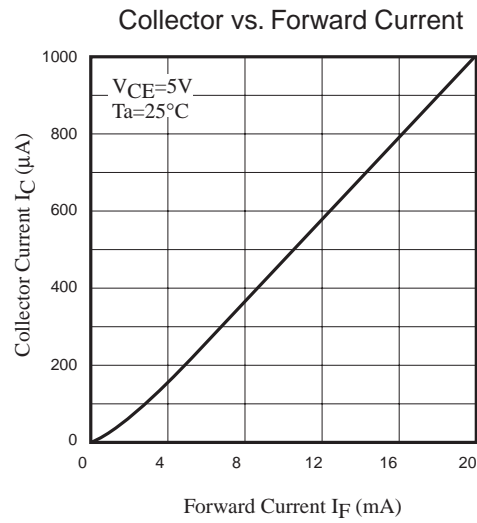
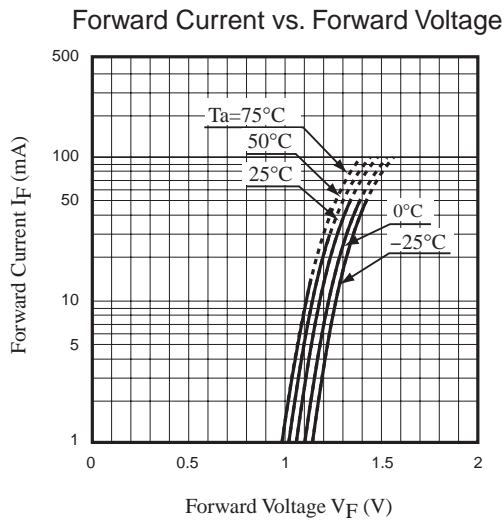
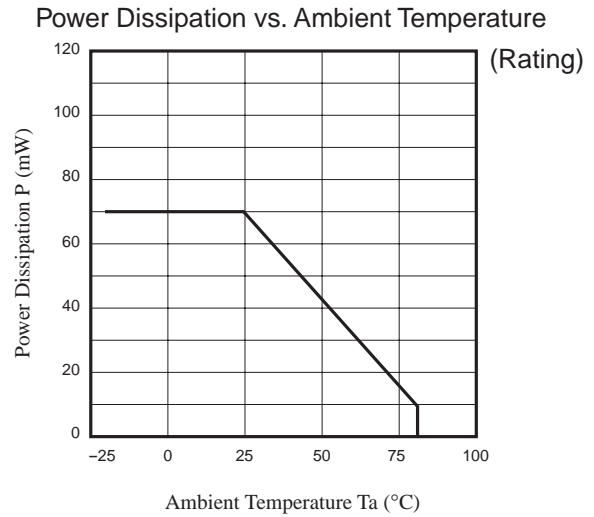
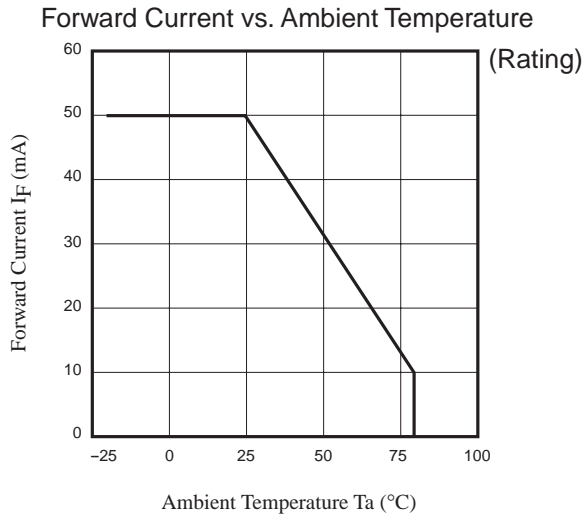

Typical Characteristics



These numerical value show the electrical and optical characteristics of this product, and not assure this contents.

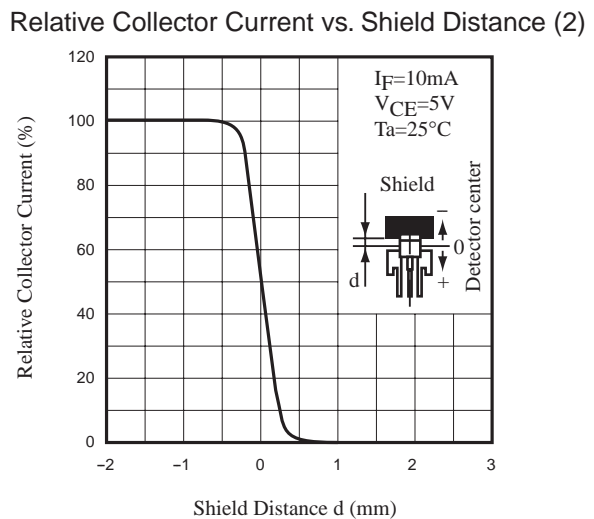
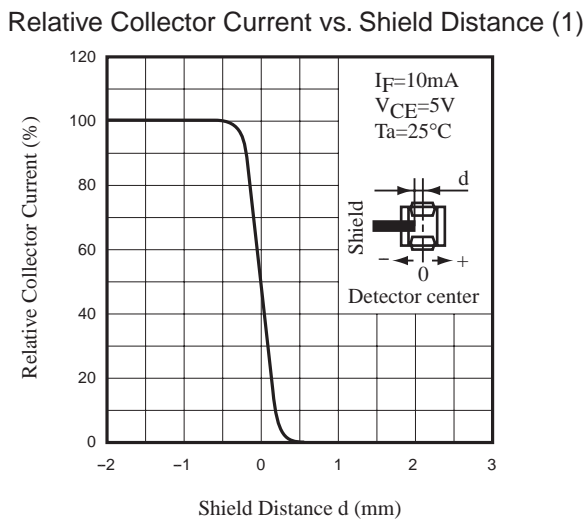
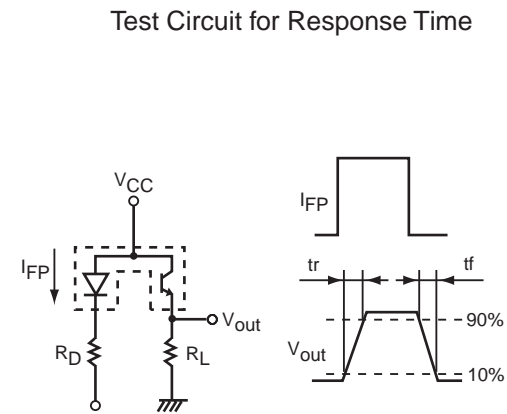
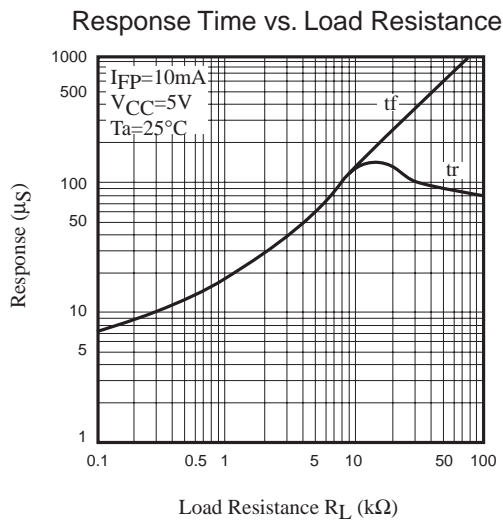
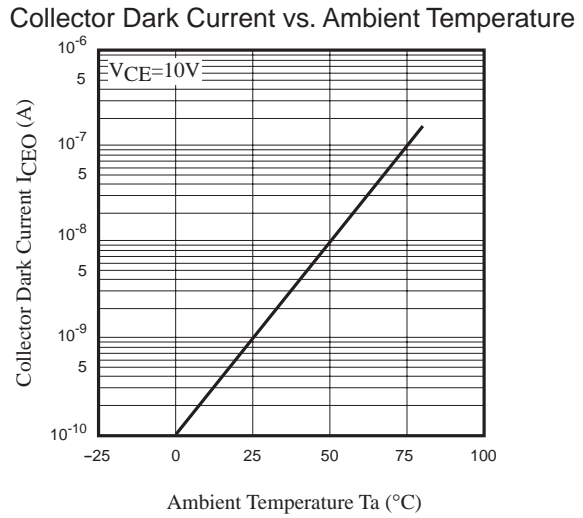
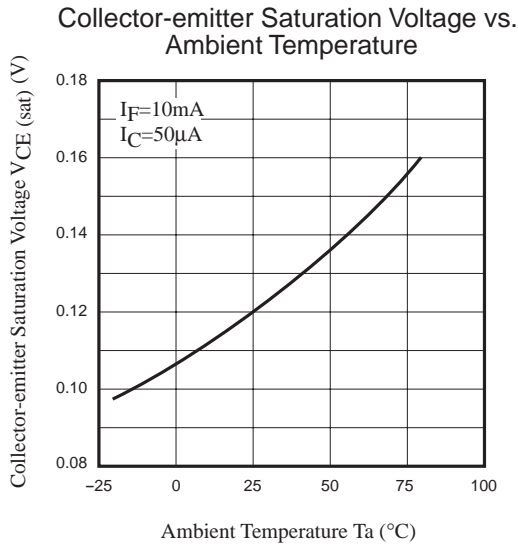

SPI-236-17

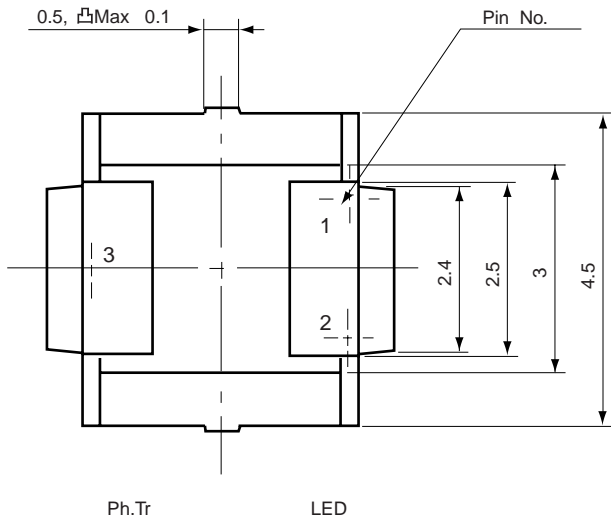

- Pin connection
1. Common (Anode)
 2. LED Cathode
 3. Ph. Tr Emitter

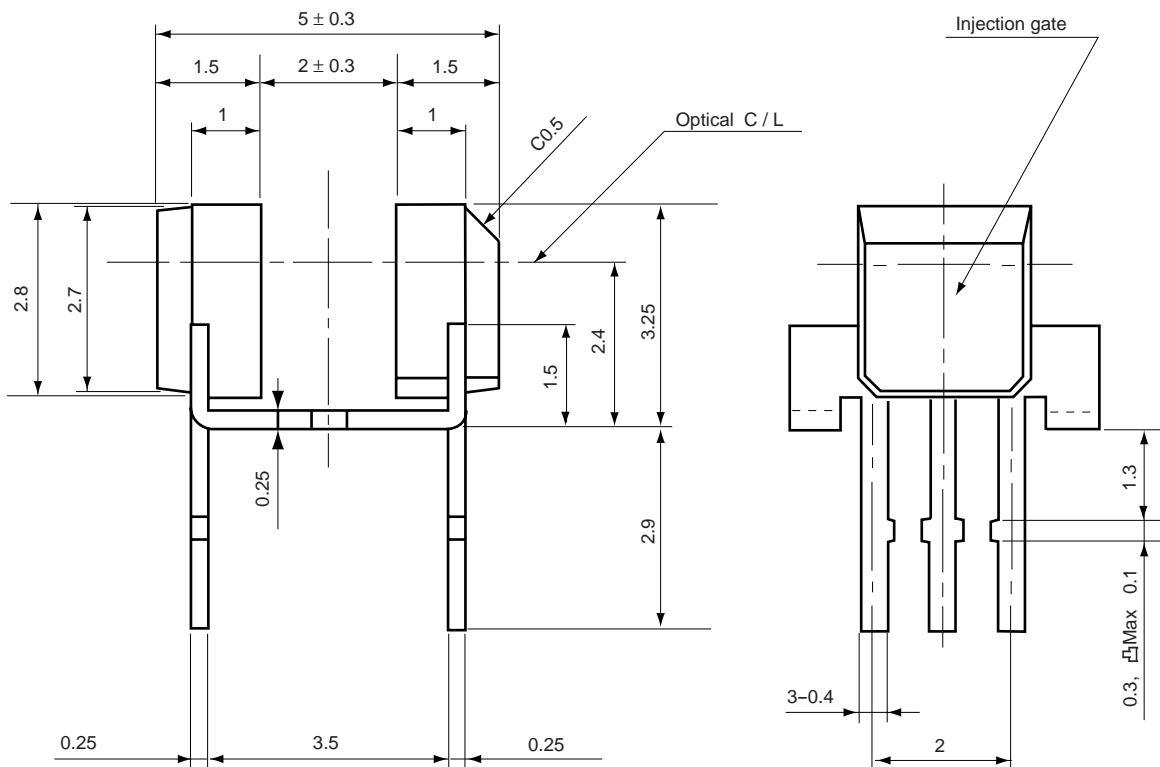

Tolerance : ± 0.2
 Unit : mm

Package dimensions and Pin connection

As stated in the sttached paper. (No.6025 4/6)

Soldering conditions

- (1) Temperature : Max. 260°C
- (2) Time : Max. 3 sec
- (3) Clearance : Min. 1mm from stay (include PCB thickness)

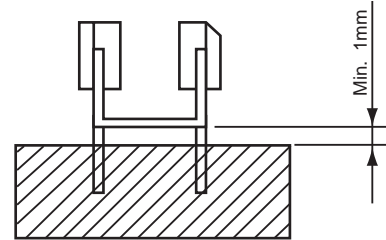

▲ PRECAUTIONS

- (1) Bending a lead should avoid. However, when bending is necessary, take care the next items.
 - ① Bending a lead must be done before soldering.
 - ② Bending a lead must be done in the states of fixing leads and no stress for the regin part. Because it is possible that stress for the regin part cause troubles such as gold wire breaking and so on.
 - ③ A lead must be bend under the stay.
 - ④ Do not bend the same position of leads more than twice.
- (2) The hole pitch of a circuit board must fit to the lead pitch.
- (3) Two stays coupling LED and Ph. Tr should be isolated from any PCB pattern or any lead.
- (4) Take care the following when soldering.
 - ① Do not heat a product under any stress (a twist and so on) to leads.
 - ② Do not heat a product in the states of operating force to the regin part.
- (5) Use the flux which contain no chlorine, have no corrosion and do not need washing.
- (6) Be careful that flux or other chemicals do not attach to the luminous surface and passive surface.

 **CAUTION**

1. No products described or contained herein are intended for use in surgical implants, life-support systems, aerospace equipment, nuclear power control systems, vehicles, disaster / crime-prevention equipment or the like, and the failure of which may directly or indirectly cause injury, death or property loss.
2. Anyone purchasing any products described or contained herein for an above-mentioned use shall:
 - 1) Accept full responsibility and indemnify and defend SANYO ELECTRIC CO.,LTD., it's affiliates, subsidiaries and distributors or any of their officers and employees, jointly and severally, against any and all claims and litigation and all damages, costs and expenses associated with such use.
 - 2) Not impose any responsibility for any fault or negligence which may be cited in any such claim or litigation on SANYO ELECTRIC CO., LTD., it's affiliates, subsidiaries and distributors or any of their officers and employees jointly or severally.
3. Information (including circuit diagrams and circuit parameters) disclosed herein is for example only; it is not guaranteed for mass production, SANYO believes the information disclosed herein is accurate and reliable, but no guarantees are made or implied regarding it's use or any infringements of intellectual property rights or other rights of third parties.

Precautionary instructions in handling gallium arsenic products

Special precautions must be taken in handling this product because it contains, gallium arsenic, which is designated as a toxic substance by law. Be sure to adhere strictly to all applicable laws and regulations enacted for this substance, particularly when it comes to disposal.

Manufactured by ; **Tottori SANYO Electric Co., Ltd.**
LED Division
5-318, Tachikawa-cho, Tottori City, 680-8634 Japan
TEL: +81-857-21-2137 FAX: +81-857-21-2161