

EVALUATION KIT  
AVAILABLE

# Broadband Variable-Gain Amplifiers

MAX3537/MAX3538

## General Description

The MAX3537/MAX3538 broadband RF variable-gain amplifiers (VGA) are designed for digital and OpenCable™ set-tops and televisions. These devices feature a unique design that integrates a dual-band (UHF and VHF) input and a low-noise, variable-gain amplifier. The integrated RF VGA covers a 10MHz to 1GHz input frequency range and provides 22dB of gain-control range.

The MAX3538 is intended for the most difficult signal conditions where performance is critical. The external pullup inductor improves IIP2 and IIP3 while also increasing gain for better sensitivity. The MAX3537 does not need an external pullup inductor and is ideal for low-power applications with less demanding receiver distortion requirements such as smaller TVs using indoor antennas.

The MAX3537/MAX3538 are specified for operation in the 0°C to +85°C temperature range and are available in 4mm x 4mm, 12-pin thin QFN packages with exposed paddle (EP).

## Applications

OpenCable Set-Top Boxes and Televisions  
Digital Set-Top Boxes  
Media Gateways  
Digital Terrestrial Receivers  
TV IF Strips

## Features

- ◆ Low-Noise VGA Eliminates PIN Attenuator
- ◆ 22dB Gain-Control Range
- ◆ Low Noise Figure: 5dB at Maximum Gain Setting
- ◆ High Linearity: +19dBm IIP3 (MAX3538) at Maximum Gain Setting
- ◆ Low Power Consumption: <200mW (MAX3537)
- ◆ Available in a 4mm x 4mm, 12-Pin Thin QFN Package

## Ordering Information

PART	TEMP RANGE	PIN-PACKAGE	PKG CODE
MAX3537UTC	0°C to +85°C	12 Thin QFN-EP*	T1244-3
MAX3537UTC+	0°C to +85°C	12 Thin QFN-EP*	T1244-3
MAX3538UTC	0°C to +85°C	12 Thin QFN-EP*	T1244-3
MAX3538UTC+	0°C to +85°C	12 Thin QFN-EP*	T1244-3

\*EP = Exposed paddle.

+Denotes lead-free package.

## Pin Configuration/ Functional Diagram

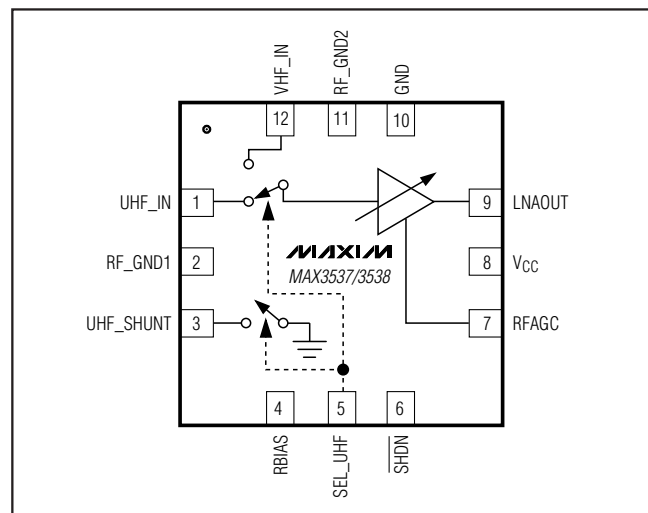

OpenCable is a trademark of Cable Television Laboratories, Inc.



Maxim Integrated Products 1

For pricing, delivery, and ordering information, please contact Maxim/Dallas Direct! at 1-888-629-4642, or visit Maxim's website at [www.maxim-ic.com](http://www.maxim-ic.com).

# Broadband Variable-Gain Amplifiers

## ABSOLUTE MAXIMUM RATINGS

V<sub>CC</sub> to GND .....-0.3V to +5.5V  
 RFAGC, UHF\_IN, SEL\_UHF, VHF\_IN, SHDN, RBIAS,  
 RF\_GND1, RF\_GND2, UHF\_SHUNT  
 to GND.....-0.3V to (V<sub>CC</sub> + 0.3V)  
 LNAOUT Short-Circuit Duration ..... 10s  
 UHF\_IN, VHF\_IN Maximum RF Input Power..... 14dBm

Continuous Power Dissipation (T<sub>A</sub> = +70°C)  
 12-Pin Thin QFN (derate 16.9mW/°C  
 above +70°C)..... 1349mW  
 Operating Temperature Range..... 0°C to +85°C  
 Junction Temperature ..... +150°C  
 Storage Temperature Range ..... -65°C to +150°C  
 Lead Temperature (soldering, 10s) ..... +300°C



**CAUTION!** ESD SENSITIVE DEVICE

Stresses beyond those listed under "Absolute Maximum Ratings" may cause permanent damage to the device. These are stress ratings only, and functional operation of the device at these or any other conditions beyond those indicated in the operational sections of the specifications is not implied. Exposure to absolute maximum rating conditions for extended periods may affect device reliability.

## DC ELECTRICAL CHARACTERISTICS

(MAX3537/MAX3538 EV kit, V<sub>CC</sub> = 4.75V to 5.25V, no RF signal applied, T<sub>A</sub> = 0°C to +85°C, unless otherwise noted. Typical values are at V<sub>CC</sub> = 5V, R<sub>BIAS</sub> = 11.8kΩ (MAX3537) or 9.1kΩ (MAX3538), T<sub>A</sub> = +25°C, unless otherwise noted.) (Note 1)

PARAMETER	CONDITIONS		MIN	TYP	MAX	UNITS
Supply Voltage			4.75		5.25	V
Supply Current	Operational mode	MAX3537		38	45.8	mA
		MAX3538		48	58	
	Standby mode (V <sub>ENABLE</sub> = V <sub>SEL_UHF</sub> = 0.1V)			2	100	μA
RFAGC Input Bias Current	V <sub>RFAGC</sub> = 1V and 3V		-50		+50	μA
RFAGC Control Voltage (Note 2)	Maximum gain		3			V
	Minimum gain				1	
Input Logic-Level Low					0.3 x V <sub>CC</sub>	V
Input Logic-Level High			0.7 x V <sub>CC</sub>			V

## AC ELECTRICAL CHARACTERISTICS (MAX3537)

(MAX3537 EV kit, V<sub>CC</sub> = 4.75V to 5.25V, T<sub>A</sub> = 0°C to +85°C, unless otherwise noted. Typical values are at V<sub>CC</sub> = 5V, R<sub>BIAS</sub> = 11.8kΩ, T<sub>A</sub> = +25°C, unless otherwise noted.) (Note 1)

PARAMETER	CONDITIONS	MIN	TYP	MAX	UNITS
Operating Frequency Range		50		878	MHz
Input Return Loss	Diplex filter included, worst case across band, any gain setting (Note 2)	4.3	8.5		dB
Input Power Range Per Channel		-35		+50	dBmV
Voltage Gain	Maximum gain	7.7	9.6	12.7	dB
Linear Gain-Control Range	Measured at 50MHz, difference between maximum and minimum gain	19.2	23.1		dB
Gain Flatness	From 50MHz to 878MHz, V <sub>RFAGC</sub> = 3V (Note 2)			2.8	dB
Noise Figure	Maximum gain, diplexer loss included	5			dB
Input 2nd-Order Intercept Point	Maximum gain, V <sub>RFAGC</sub> = 3V (Notes 2, 3)	21.6	26		dBm
	Minimum gain, V <sub>RFAGC</sub> = 1V	42.5	48		

# Broadband Variable-Gain Amplifiers

MAX3537/MAX3538

## AC ELECTRICAL CHARACTERISTICS (MAX3537) (continued)

(MAX3537 EV kit,  $V_{CC} = 4.75V$  to  $5.25V$ ,  $T_A = 0^{\circ}C$  to  $+85^{\circ}C$ , unless otherwise noted. Typical values are at  $V_{CC} = 5V$ ,  $R_{BIAS} = 11.8k\Omega$ ,  $T_A = +25^{\circ}C$ , unless otherwise noted.) (Note 1)

PARAMETER	CONDITIONS	MIN	TYP	MAX	UNITS
Input 3rd-Order Intercept Point	Maximum gain, $V_{RFAGC} = 3V$ (Note 4)	12.7	17		dBm
	Minimum gain, $V_{RFAGC} = 1V$ (Note 2)	28.2	33		
1dB Compression Point	Maximum gain (Note 2)	0	1.9		dBm
Isolation	Shutdown mode, 50MHz to 878MHz, RF input to RF output		37		dBc
	Port to port		23		
Output Return Loss	Unbalanced $75\Omega$ load		10		dB

## AC ELECTRICAL CHARACTERISTICS (MAX3538)

(MAX3538 EV kit,  $V_{CC} = 4.75V$  to  $5.25V$ ,  $T_A = 0^{\circ}C$  to  $+85^{\circ}C$ , unless otherwise noted. Typical values are at  $V_{CC} = 5V$ ,  $R_{BIAS} = 9.1k\Omega$ ,  $T_A = +25^{\circ}C$ , unless otherwise noted.) (Note 1)

PARAMETER	CONDITIONS	MIN	TYP	MAX	UNITS
Operating Frequency Range		50		878	MHz
Input Return Loss	Diplex filter included, worst case across band, any gain setting (Note 2)	5.4	8.5		dB
Input Power Range Per Channel		-35		+50	dBmV
Voltage Gain	Maximum gain	9.7	12.4	15.7	dB
Linear Gain-Control Range	Measured at 50MHz, difference between maximum and minimum gain	19	23		dB
Gain Flatness	From 50MHz to 878MHz, $V_{RFAGC} = 3V$ (Note 2)			2.9	dB
Noise Figure	Maximum gain, diplexer loss included		5		dB
Input 2nd-Order Intercept Point	Maximum gain, $V_{RFAGC} = 3V$ (Notes 2, 3)	27	34		dBm
	Minimum gain, $V_{RFAGC} = 1V$	47.6	53		
Input 3rd-Order Intercept Point	Maximum gain, $V_{RFAGC} = 3V$ (Note 4)	15.4	19		dBm
	Minimum gain, $V_{RFAGC} = 1V$ (Note 2)	30	33		
1dB Compression Point	Maximum gain. (Note 2)	2.2	4		dBm
Isolation	Shutdown mode, 50MHz to 878MHz, RF input to RF output		41		dBc
	Port to port		24		
Output Return Loss	Unbalanced $75\Omega$ load		10		dB

**Note 1:** Guaranteed by production test at  $T_A = +25^{\circ}C$  and  $+85^{\circ}C$  and does not include diplex filter loss, unless otherwise noted.

**Note 2:** Guaranteed by design and characterization from  $T_A = 0^{\circ}C$  to  $+85^{\circ}C$ .

**Note 3:** Tested with input tones at 210MHz and 660MHz at -12dBm/tone. Diplexer is not included.

**Note 4:** Tested with input tones at 760MHz and 810MHz at -12dBm/tone. Diplexer is not included.

# Broadband Variable-Gain Amplifiers

## Typical Operating Characteristics

(MAX3537 EV kit with diplex filter removed,  $V_{CC} = 5V$ ,  $V_{RFAGC} = 3V$ ,  $T_A = +25^\circ C$ , unless otherwise noted.)

### MAX3537

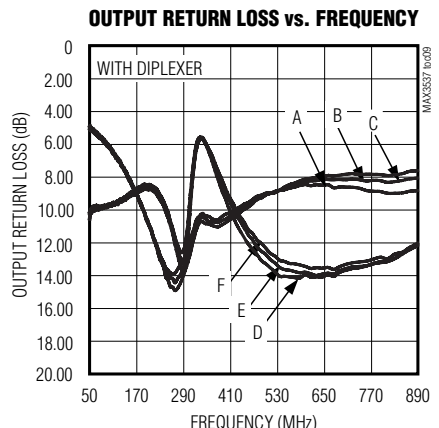
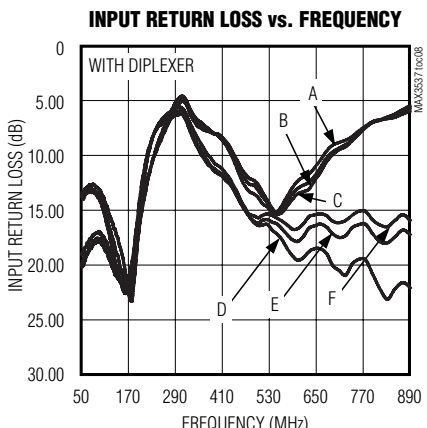
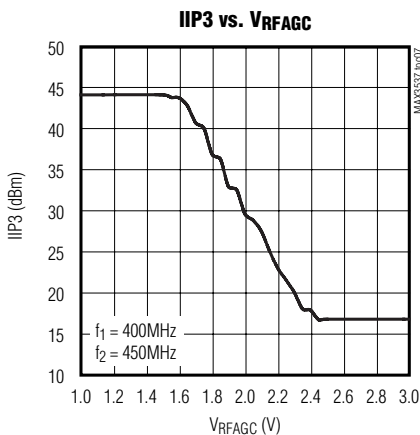
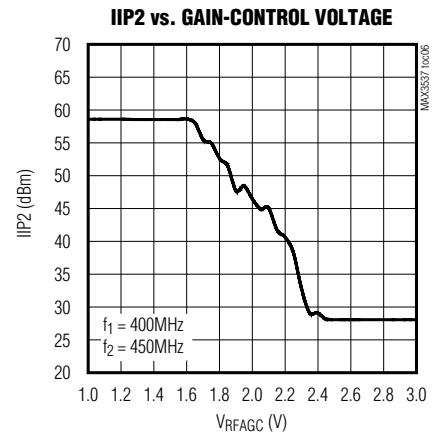
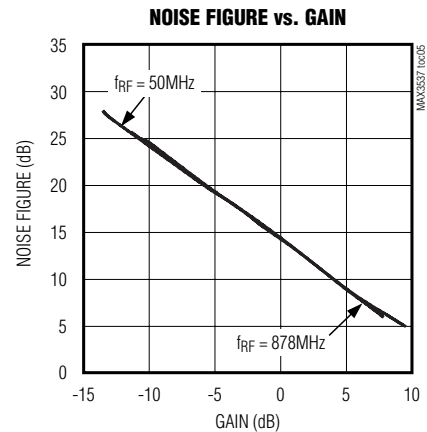
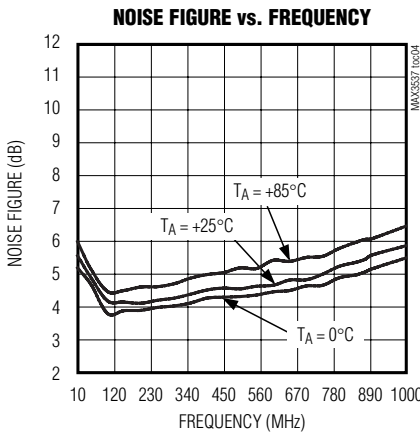
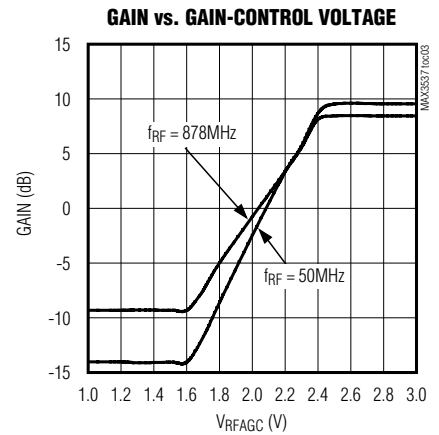
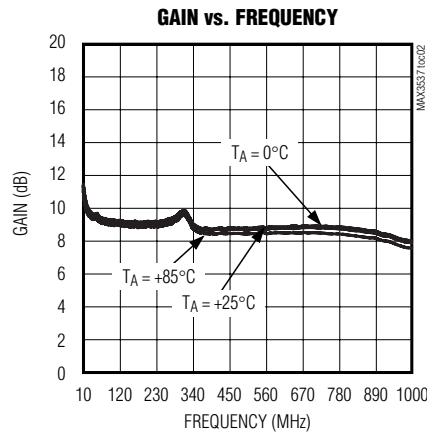
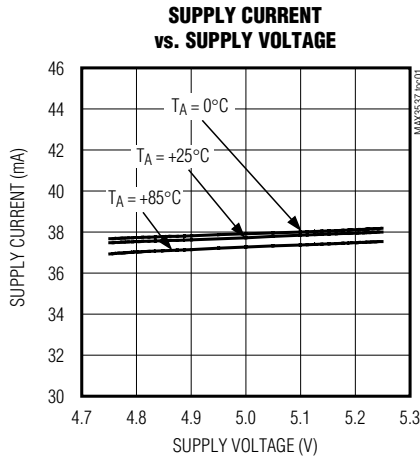

A:  $T_A = +85^\circ C$ , UHF\_IN ENABLED D:  $T_A = +85^\circ C$ , VHF\_IN ENABLED  
 B:  $T_A = +25^\circ C$ , UHF\_IN ENABLED E:  $T_A = +25^\circ C$ , VHF\_IN ENABLED  
 C:  $T_A = 0^\circ C$ , UHF\_IN ENABLED F:  $T_A = 0^\circ C$ , VHF\_IN ENABLED

A:  $T_A = +85^\circ C$ , UHF\_IN ENABLED D:  $T_A = +85^\circ C$ , VHF\_IN ENABLED  
 B:  $T_A = +25^\circ C$ , UHF\_IN ENABLED E:  $T_A = +25^\circ C$ , VHF\_IN ENABLED  
 C:  $T_A = 0^\circ C$ , UHF\_IN ENABLED F:  $T_A = 0^\circ C$ , VHF\_IN ENABLED

# Broadband Variable-Gain Amplifiers

## Typical Operating Characteristics (continued)

(MAX3537 EV kit with diplex filter removed,  $V_{CC} = 5V$ ,  $V_{RFAGC} = 3V$ ,  $T_A = +25^\circ C$ , unless otherwise noted.)

### MAX3537

**SUPPLY CURRENT AND IIP3 vs.  $R_{BIAS}$**

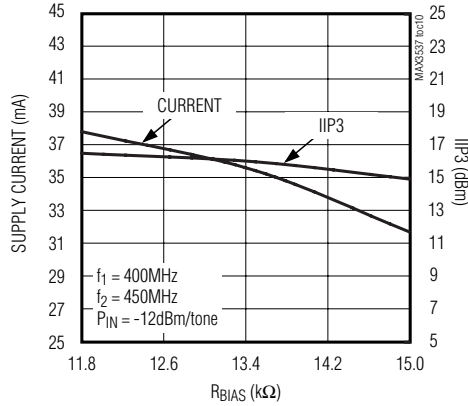

**GAIN vs.  $R_{BIAS}$**

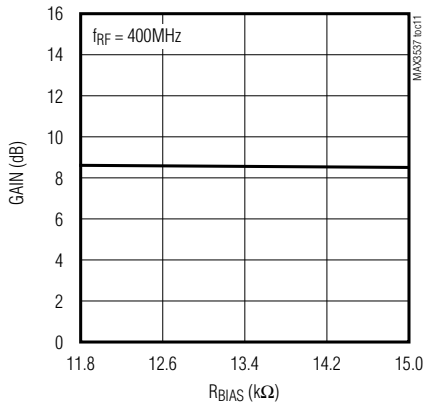

**SHUTDOWN ISOLATION vs. FREQUENCY**

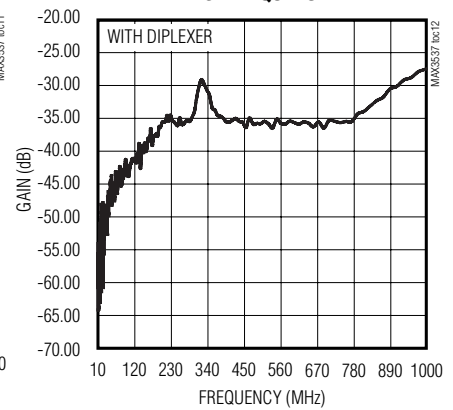

MAX3537/MAX3538

## Typical Operating Characteristics

(MAX3538 EV kit with diplex filter removed,  $V_{CC} = 5V$ ,  $V_{RFAGC} = 3V$ ,  $T_A = +25^\circ C$ , unless otherwise noted.)

### MAX3538

**SUPPLY CURRENT vs. SUPPLY VOLTAGE**

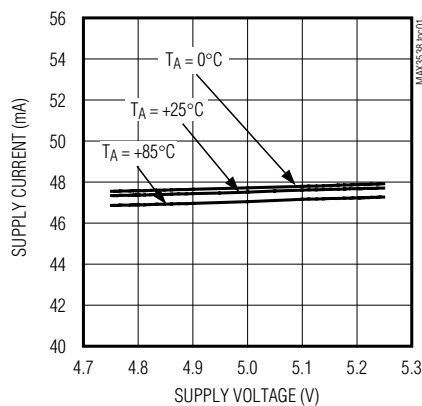

**GAIN vs. FREQUENCY**

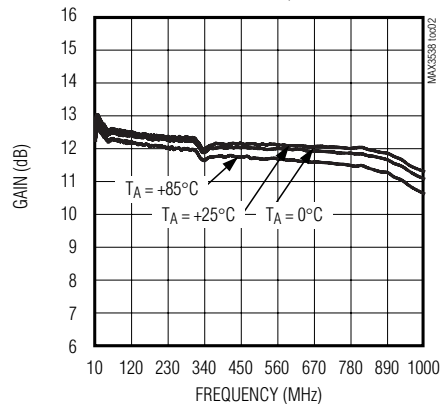

**GAIN vs. GAIN-CONTROL VOLTAGE**

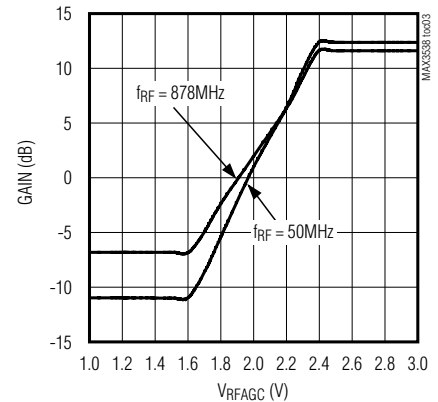

# Broadband Variable-Gain Amplifiers

## Typical Operating Characteristics (continued)

(MAX3538 EV kit with diplex filter removed,  $V_{CC} = 5V$ ,  $V_{RFAGC} = 3V$ ,  $T_A = +25^\circ C$ , unless otherwise noted.)

### MAX3538

**NOISE FIGURE vs. FREQUENCY**

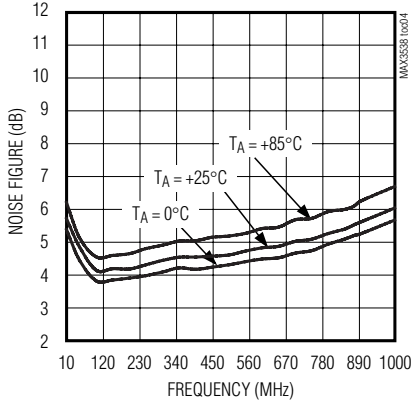

**NOISE FIGURE vs. GAIN**

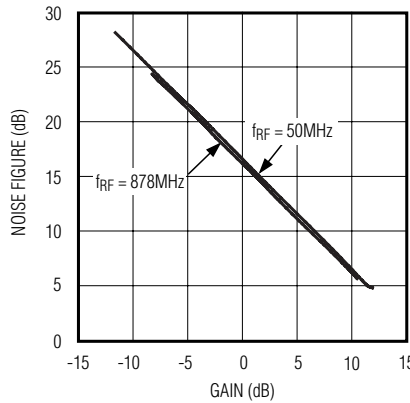

**IIP2 vs. VRFAGC**

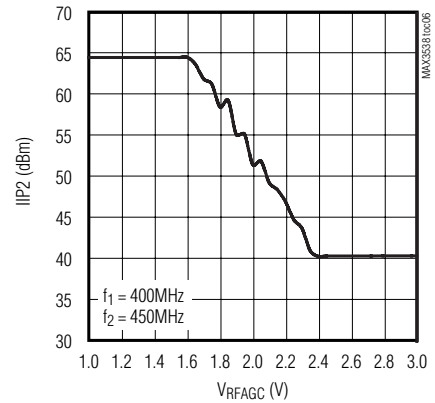

**IIP3 vs. VRFAGC**

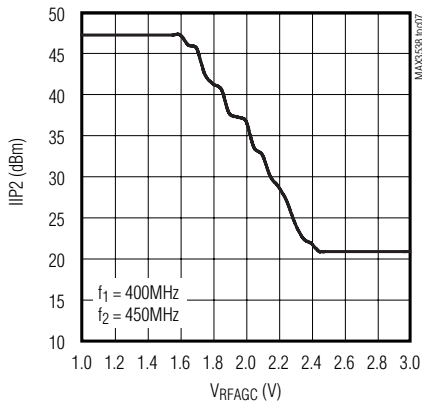

**INPUT RETURN LOSS vs. FREQUENCY**

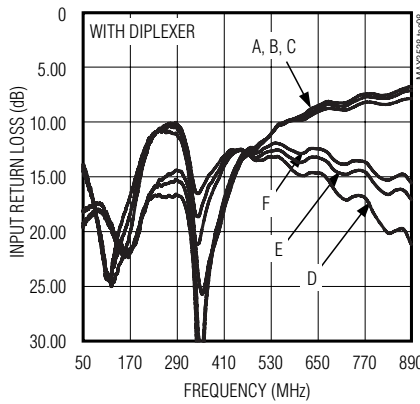

**OUTPUT RETURN LOSS vs. FREQUENCY**

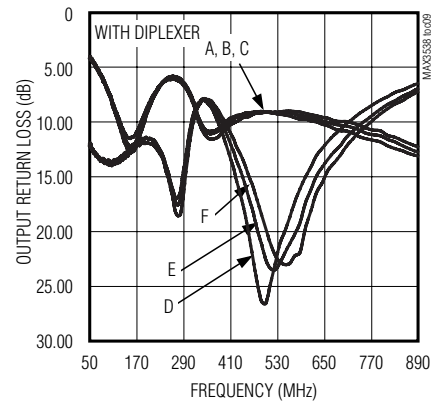

A:  $T_A = +85^\circ C$ , UHF\_IN ENABLED    D:  $T_A = +85^\circ C$ , VHF\_IN ENABLED    A:  $T_A = +85^\circ C$ , UHF\_IN ENABLED    D:  $T_A = +85^\circ C$ , VHF\_IN ENABLED  
 B:  $T_A = +25^\circ C$ , UHF\_IN ENABLED    E:  $T_A = +25^\circ C$ , VHF\_IN ENABLED    B:  $T_A = +25^\circ C$ , UHF\_IN ENABLED    E:  $T_A = +25^\circ C$ , VHF\_IN ENABLED  
 C:  $T_A = 0^\circ C$ , UHF\_IN ENABLED    F:  $T_A = 0^\circ C$ , VHF\_IN ENABLED    C:  $T_A = 0^\circ C$ , UHF\_IN ENABLED    F:  $T_A = 0^\circ C$ , VHF\_IN ENABLED

**SUPPLY CURRENT AND IIP3 vs. RBIAS**

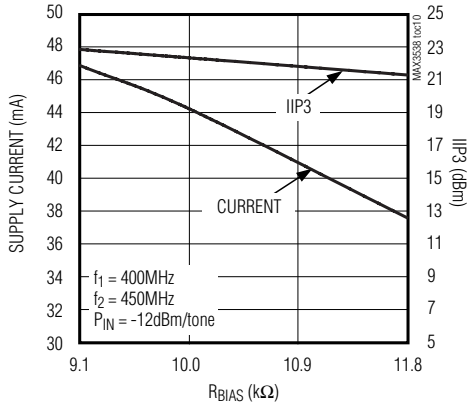

**GAIN vs. RBIAS**

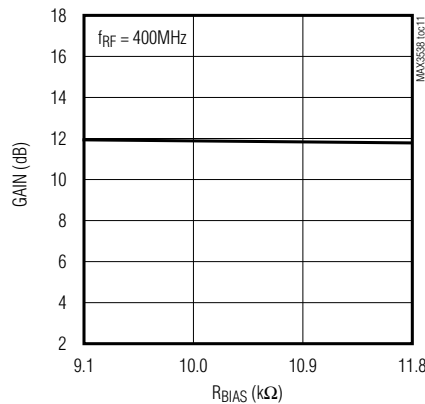

**SHUTDOWN ISOLATION vs. FREQUENCY**

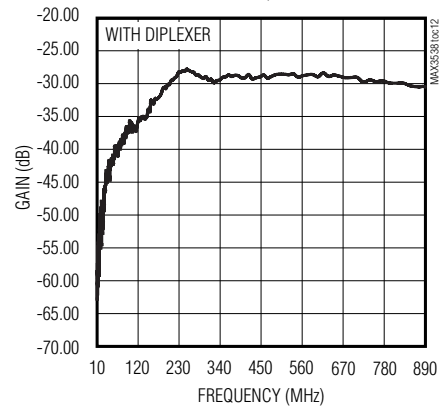

# Broadband Variable-Gain Amplifiers

## Pin Description

PIN	NAME	FUNCTION
1	UHF_IN	UHF Input. This input is terminated into 75Ω when not selected.
2	RF_GND1	First RF Ground. Connect a 1000pF capacitor from RF_GND1 to GND. <b>Do not connect RF_GND1 to RF_GND2.</b>
3	UHF_SHUNT	UHF Shunt. Connects to GND when SEL_UHF is low, high impedance when SEL_UHF is high.
4	RBIAS	Amplifier Bias. Connect an 11.8kΩ ±1% (MAX3537) or 9.1kΩ ±1% (MAX3538) resistor from RBIAS to GND.
5	SEL_UHF	Band-Select Input. Selects between the UHF and VHF inputs. Logic low to select VHF, logic high to select UHF.
6	SHDN	Shutdown. Logic low to put the device in standby mode. Logic high for normal operation.
7	RFAGC	Automatic Gain-Control Input. Accepts a DC voltage from 1V (minimum gain) to 3V (maximum gain).
8	VCC	Supply Voltage. Bypass to GND with 47pF and 1000pF capacitors placed as close to the device as possible.
9	LNAOUT	RF Output. Requires a DC-blocking capacitor. The MAX3538 requires a 560nH pullup inductor from LNAOUT to VCC.
10	GND	Ground
11	RF_GND2	Second RF Ground. Connect a 1000pF capacitor from RF_GND2 to GND. <b>Do not connect RF_GND2 to RF_GND1.</b>
12	VHF_IN	VHF Input. This input is terminated into approximately 75Ω when not selected.
EP	GND	Exposed Paddle. Solder evenly to the board's ground plane for proper operation.

MAX3537/MAX3538

## Detailed Description

The MAX3537/MAX3538 variable-gain amplifiers are designed for US digital television applications, specifically to meet ATSC's recommended receiver requirements. The MAX3538 uses an external pullup inductor for maximum linearity and gain and is ideal for performance-driven applications. The MAX3537 does not require an external pullup inductor and requires 10mA less current than the MAX3538. This results in slightly lower linearity and gain but is an acceptable option for cost- and/or power-sensitive applications. The two parts are otherwise identical and can use the same layout and application schematic except for the pullup inductor and RBIAS resistor.

### Dual-Band Inputs

The MAX3537/MAX3538 feature two RF inputs, one for the VHF band (50MHz to 230MHz) and one for the UHF band (470MHz to 810MHz). An external diplex filter attenuates the undesired band. The diplex filter is easily implemented with discrete components, see the *Typical Application Circuit* for typical component values.

Selection between the two inputs is achieved with a single digital input, SEL\_UHF. See Table 1 for a description of SEL\_UHF operation. The VHF and UHF inputs are terminated into approximately 75Ω when not selected.

Table 1. SEL\_UHF Operation

SEL_UHF	FUNCTION
0	Receive VHF channels (50MHz to 230MHz) or cable channels below approximately 305MHz.
1	Receive UHF channels (470MHz to 810MHz) or cable channels above approximately 305MHz.

### Broadband Variable-Gain Amplifier (VGA)

The MAX3537/MAX3538 integrate a broadband low-noise variable-gain amplifier. The MAX3538 VGA has an open-collector output and requires a pullup inductor to VCC, while the MAX3537 has an internal pullup to VCC. Both the MAX3537 and MAX3538 outputs require a DC-blocking capacitor.

The MAX3537/MAX3538 provide a 22dB gain-control range for increased system linearity. A DC voltage applied at the RFAGC pin controls the devices' overall gain, and can range from 1V to 3V with 3V providing the maximum gain setting.

# Broadband Variable-Gain Amplifiers

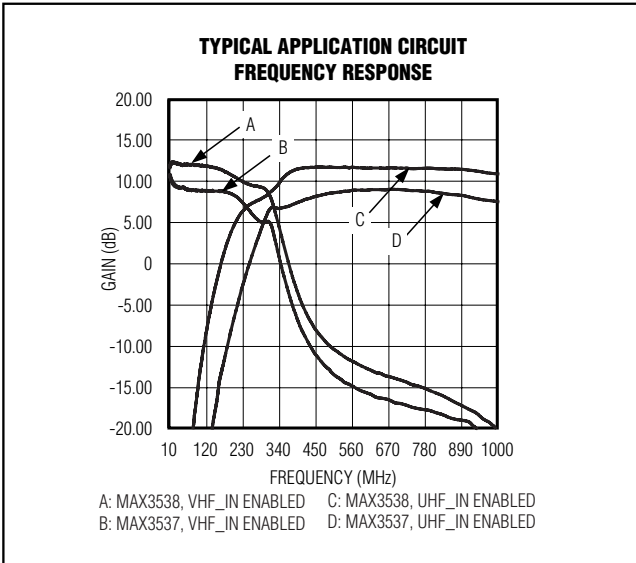

Figure 1. Frequency Response of the MAX3537/MAX3538 Typical Application Circuit

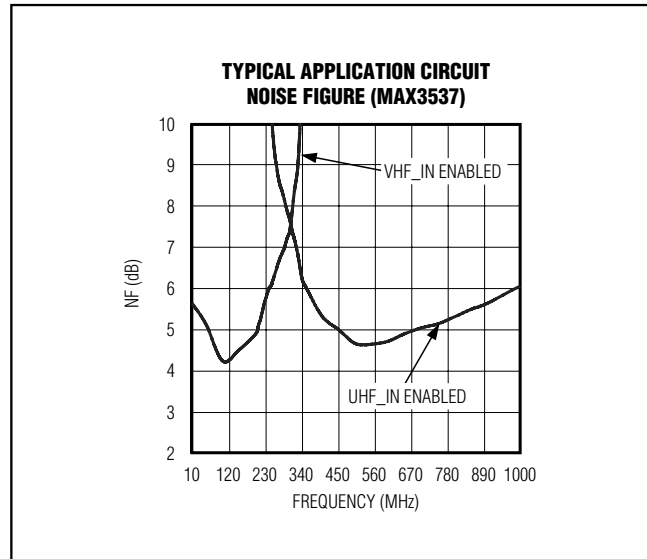

Figure 2. Noise Figure of MAX3537 Typical Application Circuit

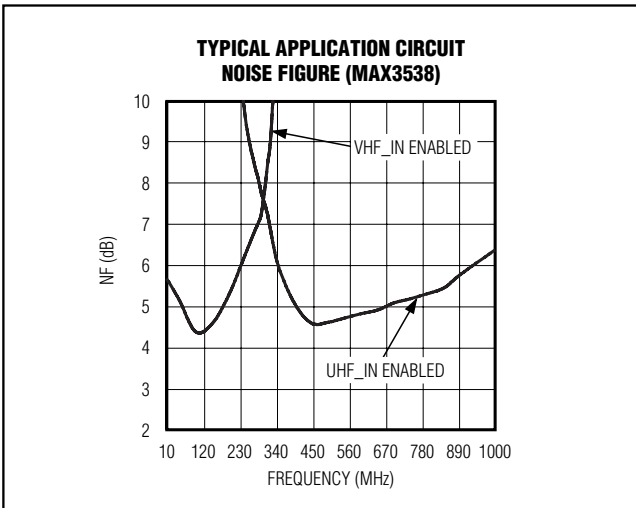

Figure 3. Noise Figure of MAX3538 Typical Application Circuit

## Applications Information

### Terrestrial Television Applications

Television receivers having dedicated RF inputs for cable and terrestrials reception can optimize the terrestrial path to better meet the difficult requirements recommended by ATSC. For dedicated terrestrial reception, the diplex filter is optimized for reception of VHF and UHF channels (50MHz to 230MHz, and 470MHz to 810MHz). The diplex

filter attenuates the undesired channels, improving second-order distortion performance.

### Terrestrial + Cable Television Applications

Television receivers having one RF input or multiple inputs that must receive cable and terrestrial channels must cover a 50MHz to 860MHz frequency range. The diplex filter must allow reception within this range while still providing attenuation of the undesired band. The *Typical Application Circuit* provides acceptable gain and noise figure performance over the diplexer transition band between VHF and UHF, see Figures 1 and 3.

### Layout Considerations

The EV kit serves as a guide for PC board layout. Keep RF signal lines as short as possible to minimize losses and radiation. Use controlled impedance on all high-frequency traces. For proper operation, solder the exposed paddle evenly to the ground plane. Use abundant vias beneath the exposed paddle for maximum heat dissipation. Use abundant ground vias between RF traces to minimize undesired coupling. Bypass VCC to ground with 47nF and 1000nF capacitors placed as close to the pin as possible, with the 47nF capacitor closest to the device.

## Chip Information

TRANSISTOR COUNT: 1982

PROCESS: BiCMOS



# Broadband Variable-Gain Amplifiers

## Typical Application Circuit

**MAX3537/MAX3538**

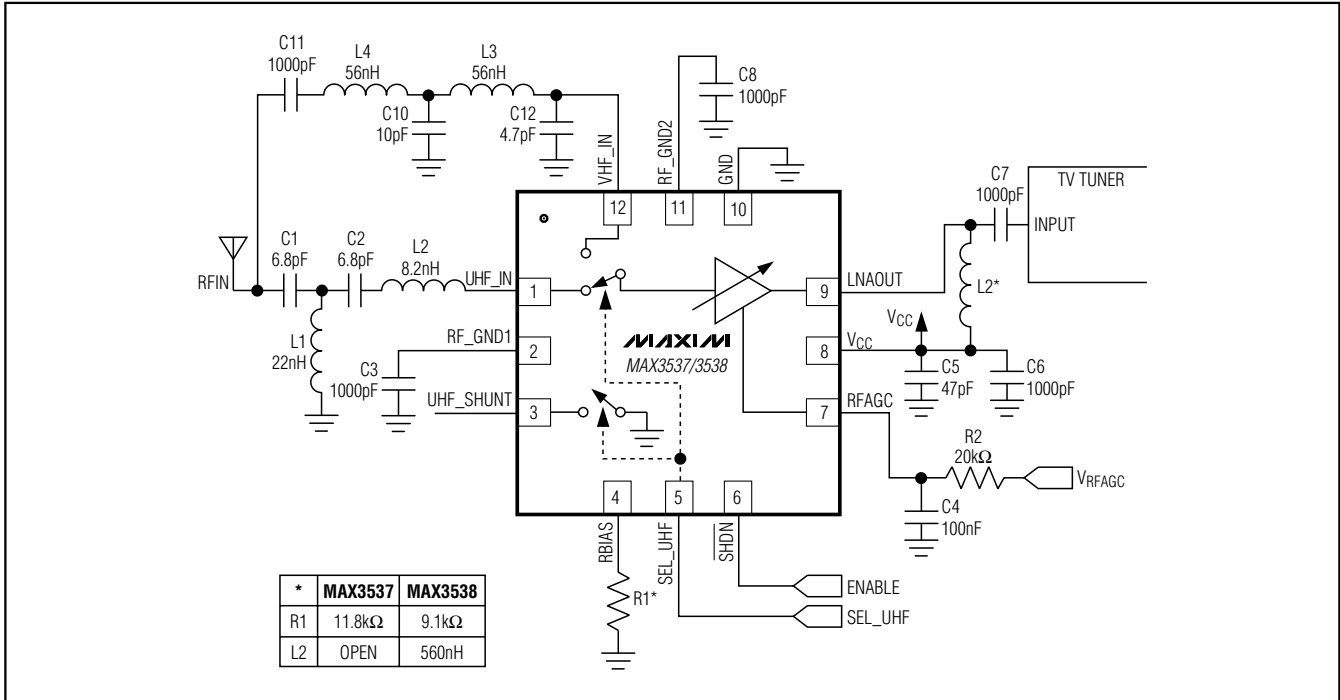
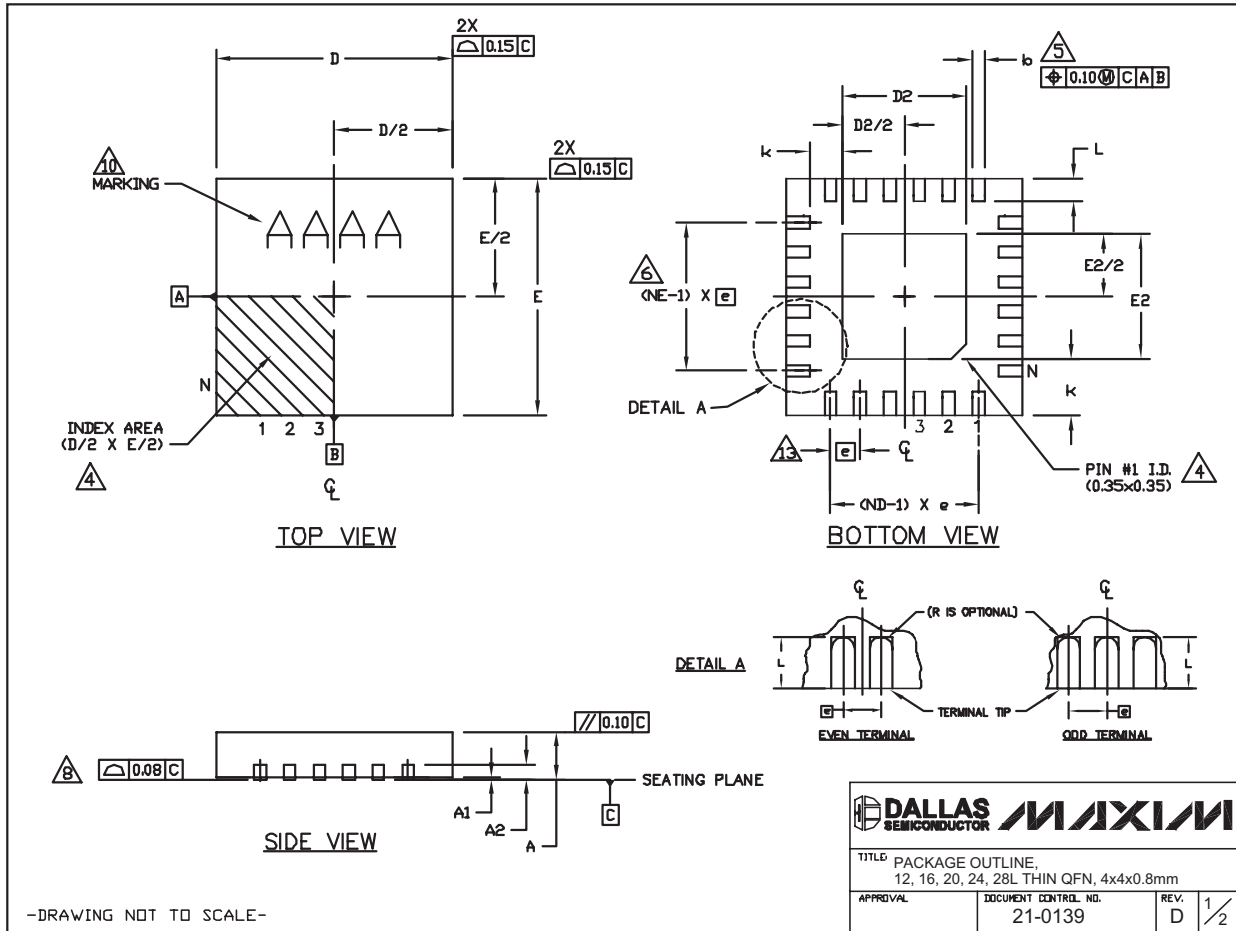

Figure 4. Typical Application Circuit

# Broadband Variable-Gain Amplifiers

## Package Information

(The package drawing(s) in this data sheet may not reflect the most current specifications. For the latest package outline information, go to [www.maxim-ic.com/packages](http://www.maxim-ic.com/packages).)



# Broadband Variable-Gain Amplifiers

## Package Information (continued)

(The package drawing(s) in this data sheet may not reflect the most current specifications. For the latest package outline information, go to [www.maxim-ic.com/packages](http://www.maxim-ic.com/packages).)

MAX3537/MAX3538

COMMON DIMENSIONS															EXPOSED PAD VARIATIONS								
PKG REF.	12L 4x4			16L 4x4			20L 4x4			24L 4x4			28L 4x4			PKG. CODES	D2			E2			DOWN BONDS ALLOWED
	MIN.	NOM.	MAX.	MIN.	NOM.	MAX.	MIN.	NOM.	MAX.	MIN.	NOM.	MAX.	MIN.	NOM.	MAX.		MIN.	NOM.	MAX.	MIN.	NOM.	MAX.	
A	0.70	0.75	0.80	0.70	0.75	0.80	0.70	0.75	0.80	0.70	0.75	0.80	0.70	0.75	0.80	T1244-2	1.95	2.10	2.25	1.95	2.10	2.25	NO
A1	0.0	0.02	0.05	0.0	0.02	0.05	0.0	0.02	0.05	0.0	0.02	0.05	0.0	0.02	0.05	T1244-3	1.95	2.10	2.25	1.95	2.10	2.25	YES
A2	0.20 REF			0.20 REF			0.20 REF			0.20 REF			0.20 REF			T1244-4	1.95	2.10	2.25	1.95	2.10	2.25	NO
b	0.25	0.30	0.35	0.25	0.30	0.35	0.20	0.25	0.30	0.18	0.23	0.30	0.15	0.20	0.25	T1644-2	1.95	2.10	2.25	1.95	2.10	2.25	NO
D	3.90	4.00	4.10	3.90	4.00	4.10	3.90	4.00	4.10	3.90	4.00	4.10	3.90	4.00	4.10	T1644-3	1.95	2.10	2.25	1.95	2.10	2.25	YES
E	3.90	4.00	4.10	3.90	4.00	4.10	3.90	4.00	4.10	3.90	4.00	4.10	3.90	4.00	4.10	T1644-4	1.95	2.10	2.25	1.95	2.10	2.25	NO
e	0.80 BSC.			0.65 BSC.			0.50 BSC.			0.50 BSC.			0.40 BSC.			T2044-1	1.95	2.10	2.25	1.95	2.10	2.25	NO
k	0.25	-	-	0.25	-	-	0.25	-	-	0.25	-	-	0.25	-	-	T2044-2	1.95	2.10	2.25	1.95	2.10	2.25	YES
L	0.45	0.55	0.65	0.45	0.55	0.65	0.45	0.55	0.65	0.30	0.40	0.50	0.30	0.40	0.50	T2044-3	1.95	2.10	2.25	1.95	2.10	2.25	NO
N	12			16			20			24			28			T2444-1	2.45	2.60	2.63	2.45	2.60	2.63	NO
ND	3			4			5			6			7			T2444-2	1.95	2.10	2.25	1.95	2.10	2.25	YES
NE	3			4			5			6			7			T2444-3	2.45	2.60	2.63	2.45	2.60	2.63	YES
Jedec Pkg.	VGG3			VGGC			WGGD-1			WGGD-2			WGGE			T2444-4	2.45	2.60	2.63	2.45	2.60	2.63	NO
																T2844-1	2.50	2.60	2.70	2.50	2.60	2.70	NO

NOTES:

- DIMENSIONING & TOLERANCING CONFORM TO ASME Y14.5M-1994.
- ALL DIMENSIONS ARE IN MILLIMETERS. ANGLES ARE IN DEGREES.
- N IS THE TOTAL NUMBER OF TERMINALS.
- THE TERMINAL #1 IDENTIFIER AND TERMINAL NUMBERING CONVENTION SHALL CONFORM TO JEDEC 95-1 SPP-012. DETAILS OF TERMINAL #1 IDENTIFIER ARE OPTIONAL, BUT MUST BE LOCATED WITHIN THE ZONE INDICATED. THE TERMINAL #1 IDENTIFIER MAY BE EITHER A MOLD OR MARKED FEATURE.
- DIMENSION b APPLIES TO METALLIZED TERMINAL AND IS MEASURED BETWEEN 0.25 mm AND 0.30 mm FROM TERMINAL TIP.
- ND AND NE REFER TO THE NUMBER OF TERMINALS ON EACH D AND E SIDE RESPECTIVELY.
- DEPOPULATION IS POSSIBLE IN A SYMMETRICAL FASHION.
- COPLANARITY APPLIES TO THE EXPOSED HEAT SINK SLUG AS WELL AS THE TERMINALS.
- DRAWING CONFORMS TO JEDEC M0220, EXCEPT FOR T2444-1, T2444-3, T2444-4 AND T2844-1.
- MARKING IS FOR PACKAGE ORIENTATION REFERENCE ONLY.
- COPLANARITY SHALL NOT EXCEED 0.08mm
- WARPAGE SHALL NOT EXCEED 0.10mm
- LEAD CENTERLINES TO BE AT TRUE POSITION AS DEFINED BY BASIC DIMENSION "e", ±0.05.

-DRAWING NOT TO SCALE-

TITLE PACKAGE OUTLINE, 12, 16, 20, 24, 28L THIN QFN, 4x4x0.8mm			
APPROVAL	DOCUMENT CONTROL NO.	REV.	2/2
	21-0139	D	

Maxim cannot assume responsibility for use of any circuitry other than circuitry entirely embodied in a Maxim product. No circuit patent licenses are implied. Maxim reserves the right to change the circuitry and specifications without notice at any time.

Maxim Integrated Products, 120 San Gabriel Drive, Sunnyvale, CA 94086 408-737-7600 \_\_\_\_\_ 11