

TSSOP28 Socket/Footprint card

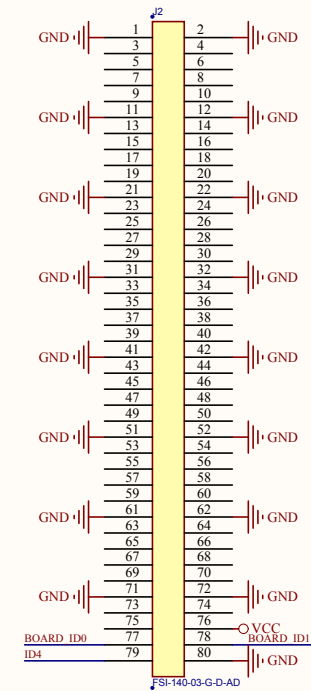
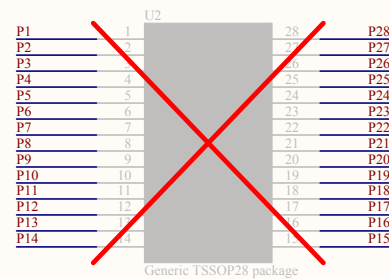
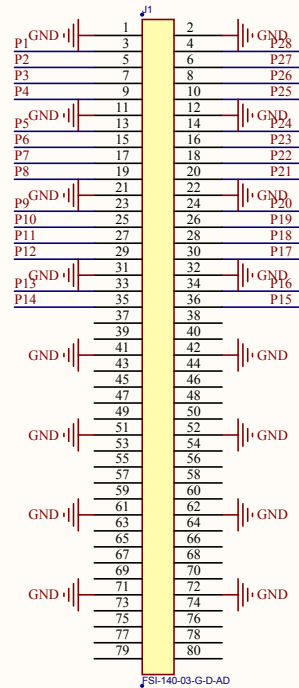
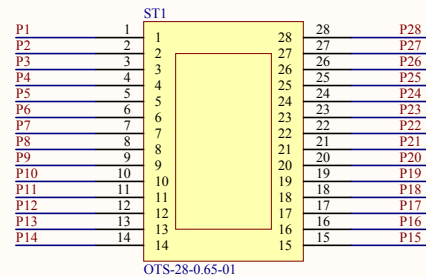
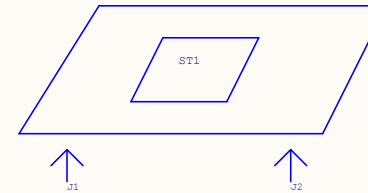

Z1
Document
STK600-TSSOP28 PCBA Documentation

LABEL1
Product number/revision
Serial number
Label PCBA

PCB1
PCB STK600-TSSOP28 PCB
Design comment:

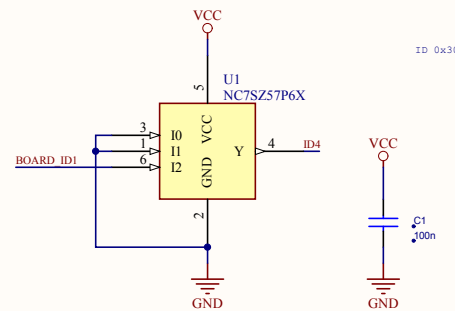
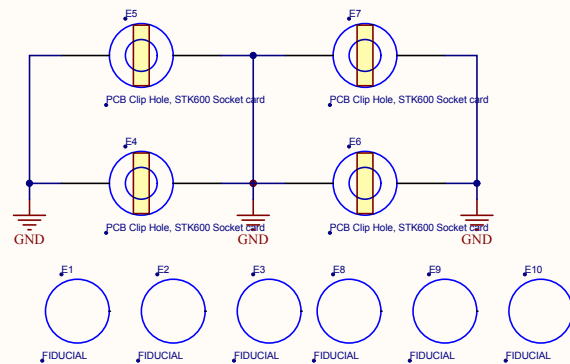

Title		
TSSOP28 Socket and Footprint Card		
Size	Document Number	Rev
A	.	J
Date:	Sheet	J of J