

DETAILS

Product Number	CN14238_WINNIE-W
Family	Winnie
Type	Assembly
Color	white
Diameter	49,8 mm
Height	19,3 mm
Style	round
Optic Material	PMMA
Holder Material	
Fastening	screw
Status	production ready
ROHS Compliant	Yes
Date Updated	11/04/2017



OPTICAL PROPERTIES

LED	Viewing Angle	Light Beam	Efficiency	cd/lm	Connector
VERO10	49 deg	Wide	90 %	1.100	-
V6 Gen6	47 deg	Wide	87 %	1.200	-
V8 Gen6	48 deg	Wide	88 %	1.100	-
V18 Gen6	56 deg	Wide	88 %	0.820	-
CLL01x	45 deg	Wide	87 %	1.200	-
CLL02x/CLU02x (LES10)	46 deg	Wide	87 %	1.600	-
CLL03x/CLU03x	48 deg	Wide	88 %	1.000	Bender Wirth: 433 Typ L5
CLU710/711	47 deg	Wide	87 %	1.000	-
CLL02x/CLU02x (LES10)	46 deg	Wide	87 %	1.100	Bender Wirth: 434 Typ L5
CLU700/701	42 deg	Wide	88 %	1.300	Bender Wirth: 434 Typ L5
CLU720/721	45 deg	Wide	87 %	1.200	Bender Wirth: 433 Typ L5
CLU700/701	42 deg	Wide	88 %	1.300	-
CLU710/711	45 deg	Wide	88 %	1.200	Bender Wirth: 470 Typ L5
CXA/B 15xx	52 deg	Wide	87 %	1.100	-
CXA/B 13xx	51 deg	Wide	89 %	1.100	-
MHD-E/G	45 deg	Wide	88 %	1.100	-
LUXEON CoB 1202s	46 deg	Wide	89 %	1.300	-
LUXEON CoB 1202/1203	48 deg	Wide	88 %	1.100	-
LUXEON CoB Compact	sim: 46	Wide	sim: 89 %	sim: 1.300	-
CXM-9	48 deg	Wide	90 %	1.300	-
CXM-14	50 deg	Wide	86 %	1.000	-
CXM-14	sim: 48	Wide	sim: 88 %	sim: 1.000	Bender Wirth: 433 Typ L5
CXM-9	sim: 46	Wide	sim: 87 %	sim: 1.100	Bender Wirth: 434 Typ L5
Soleriq P6	46 deg	Wide	88 %	1.200	-
Soleriq P9	48 deg	Wide	88 %	1.100	-

OPTICAL PROPERTIES

LED	Viewing Angle	Light Beam	Efficiency	cd/lm	Connector
Soleriq P13	49 deg	Wide	86 %	1.100	-
Soleriq S13	49 deg	Wide	87 %	1.000	-
Soleriq S19	50 deg	Wide	84 %	1.000	-
Duris S10	54 deg	Wide	88 %	1.000	-
Soleriq S9	sim: 45	Wide	sim: 90 %	sim: 1.200	-
LC010C	sim: 45	Wide	sim: 91 %	sim: 1.200	Bender Wirth: 479 Typ L5
LC020C	sim: 45	Wide	sim: 89 %	sim: 1.200	Bender Wirth: 479 Typ L5
LC040C	sim: 45	Wide	sim: 88 %	sim: 1.200	Bender Wirth: 479 Typ L5
COB D Series LES 9.8 mm	47 deg	Wide	88 %	1.100	-
COB D Series LES 14.5 mm	52 deg	Wide	85 %	0.920	-
ZC12/18	48 deg	Wide	89 %	1.100	Bender Wirth: 433 Typ L5
ZC4/6	sim: 46	Wide	sim: 87 %	sim: 1.100	Bender Wirth: 434 Typ L5
MJT COB LES 9.8	46 deg	Wide	90 %	1.100	Bender Wirth: 434 Typ L5
MJT COB LES 14.5	51 deg	Wide	84 %	0.900	Bender Wirth: 433 Typ L5
SLE G5 LES6	43 deg	Wide	88 %	1.300	-
SLE G5 LES11	41 deg	Wide	86 %	1.400	-
SLE G5 LES15	47 deg	Wide	89 %	1.100	Bender Wirth: 433 Typ L5
SLE G6 LES15	sim: 49	Wide	sim: 92 %	sim: 1.100	Bender Wirth: 433 Typ L5
SLE G6 LES17	sim: 48	Wide	sim: 92 %	sim: 1.140	Bender Wirth: 433 Typ L5
SLE G6 LES10	sim: 48	Wide	sim: 91 %	sim: 0.000	Bender Wirth: 434 Typ L5
DMC 124 / 125	45 deg	Wide	89 %	1.200	Bender Wirth: 433 Typ L5
DMC 128	49 deg	Wide	88 %	1.000	Bender Wirth: 433 Typ L5

Relative intensity of CN14238_WINNIE-W_(V6)

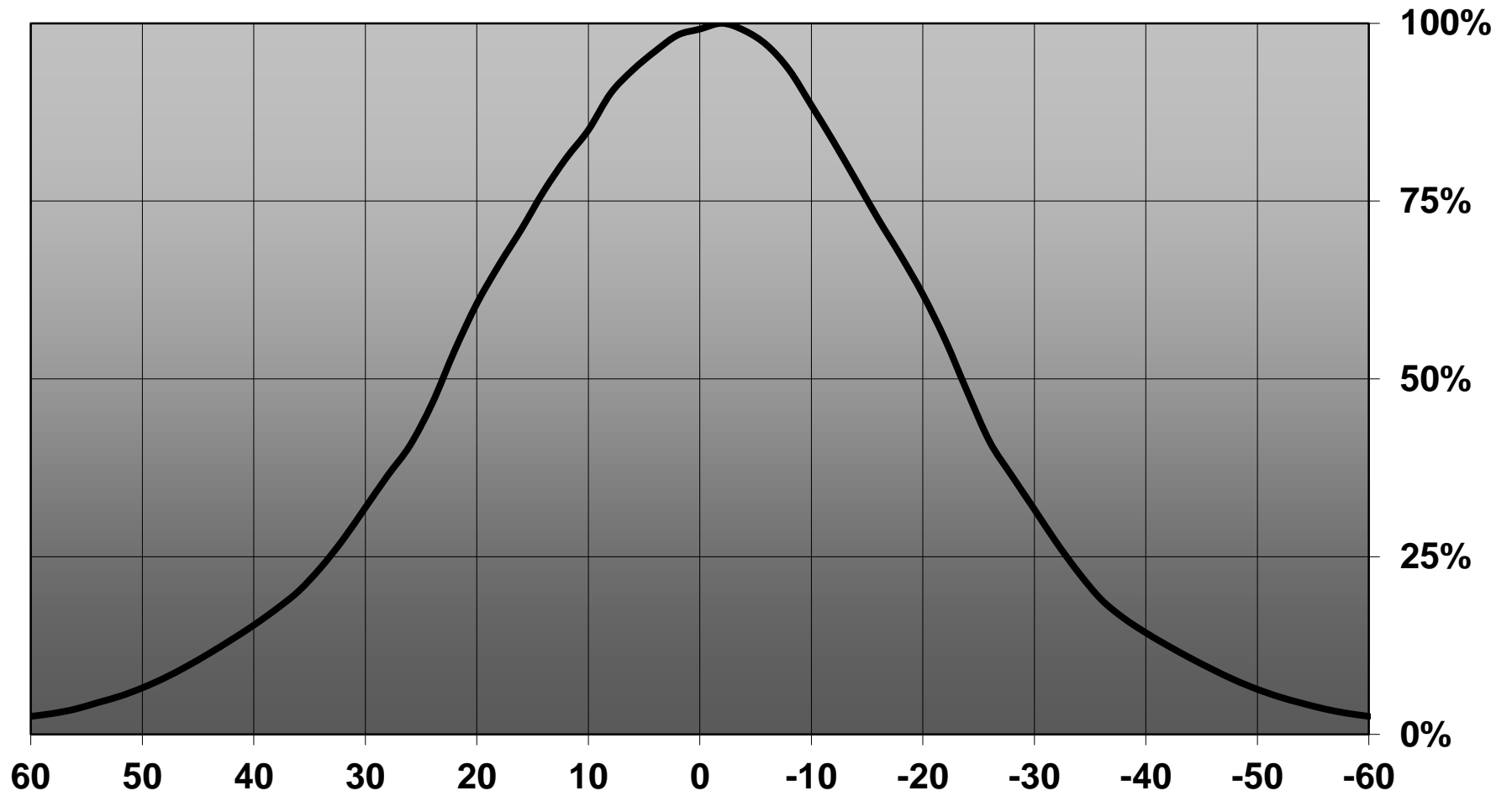

Relative intensity of CN14238_WINNIE-W_(V8)

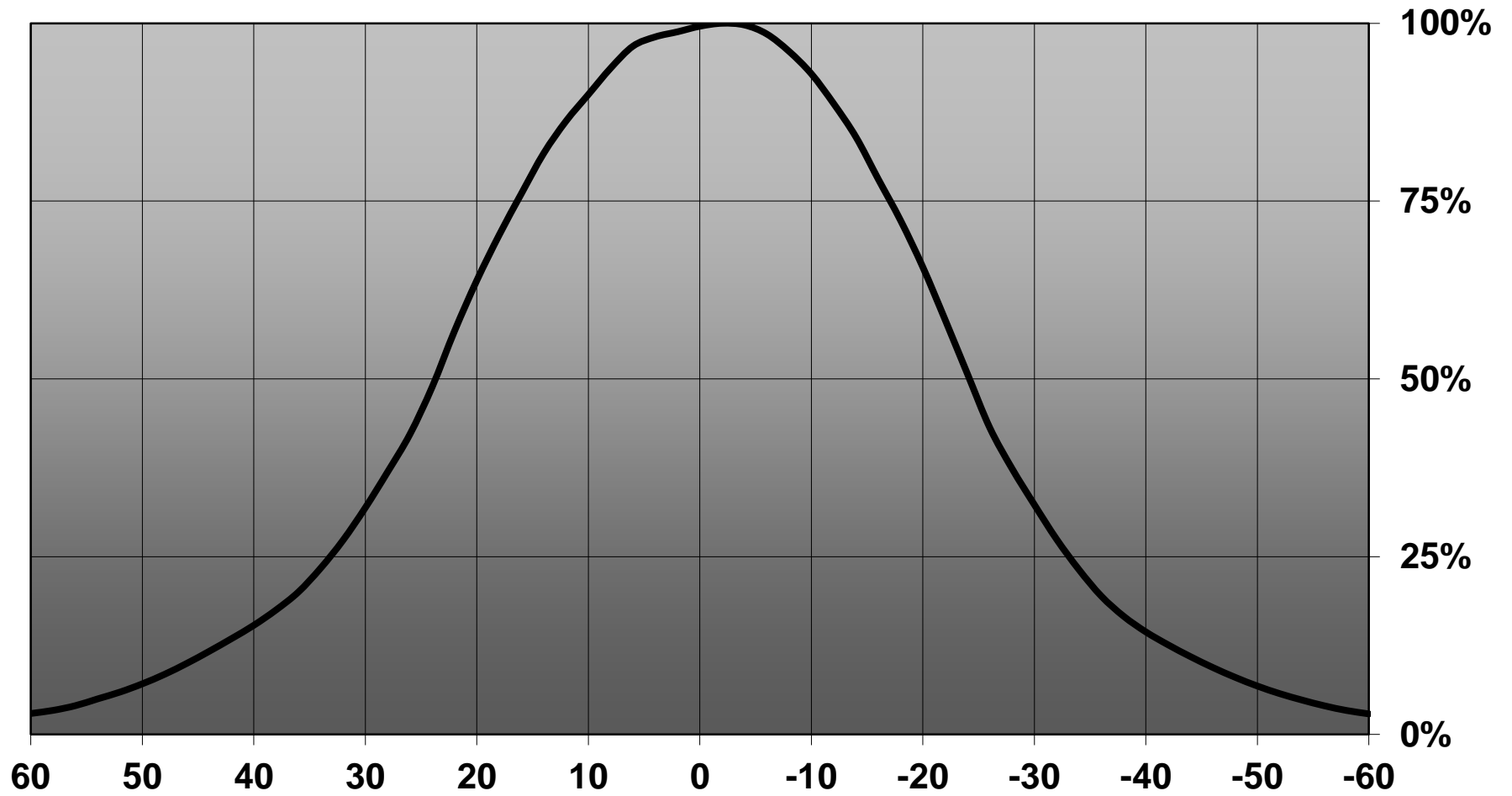

Relative intensity of CN14238_WINNIE-W_(CLL010)

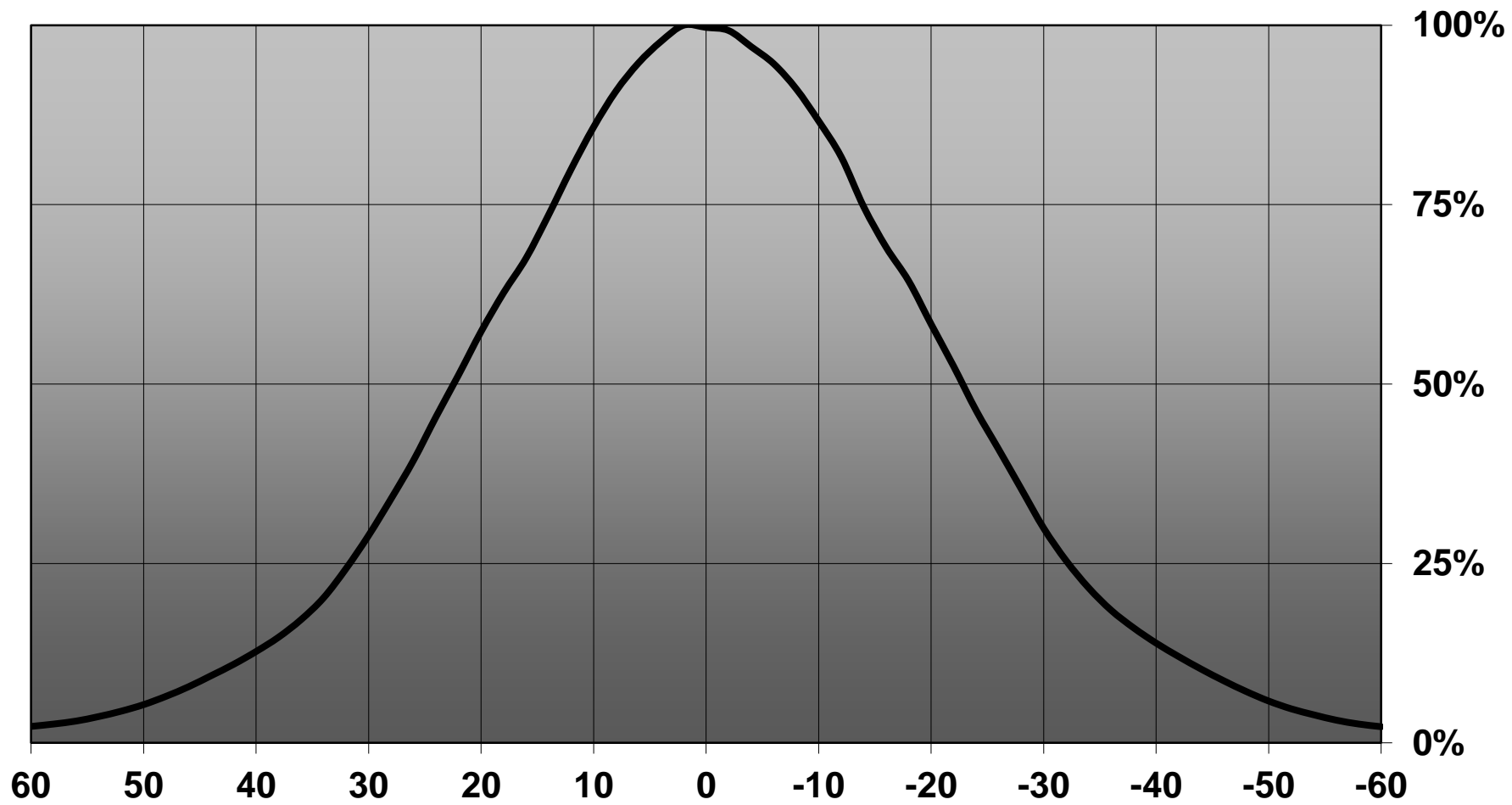

Relative intensity of CN14238_WINNIE-W_(CLL020)

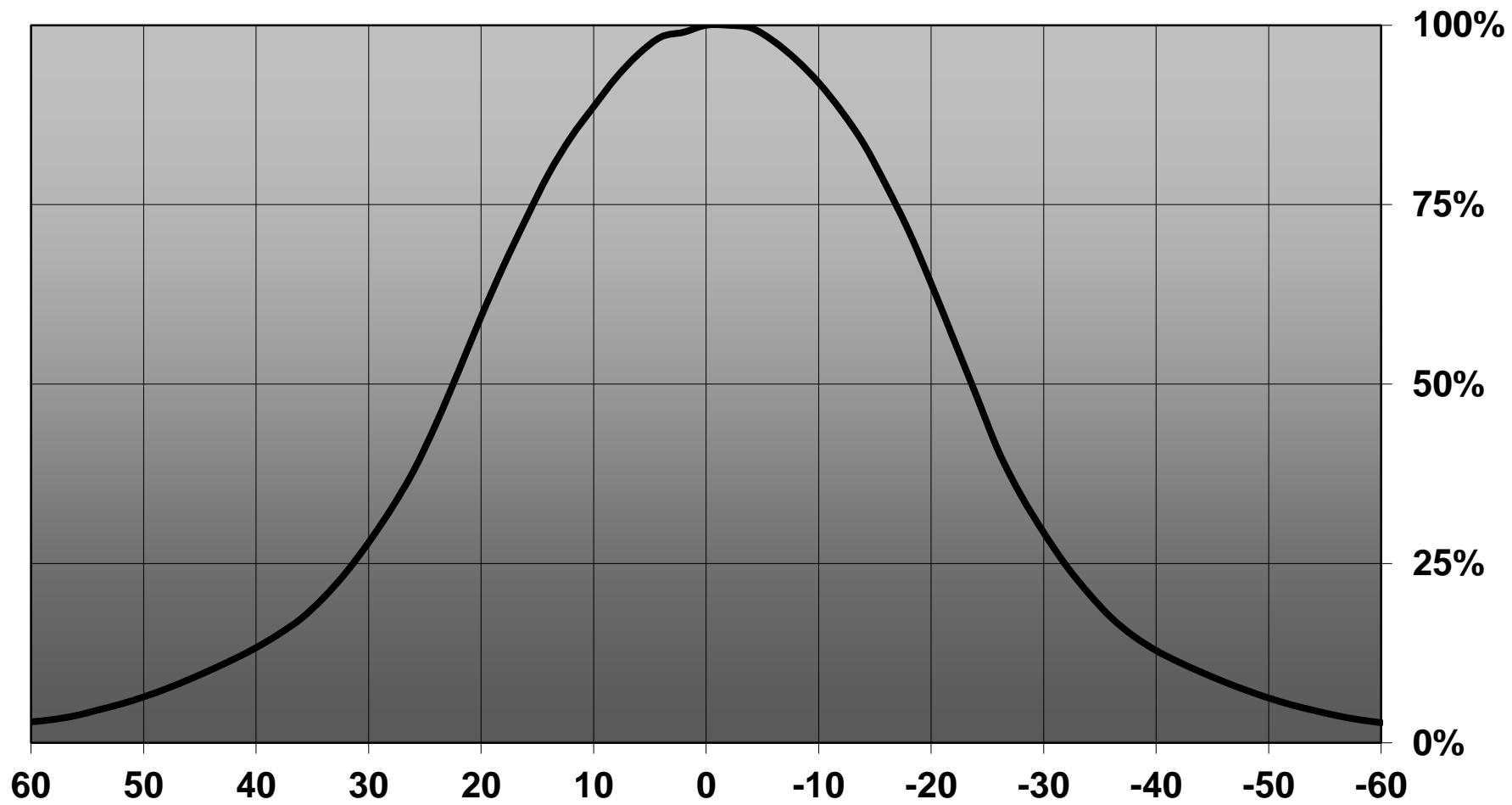

Relative intensity of CN14238_WINNIE-W_(CXA1520)

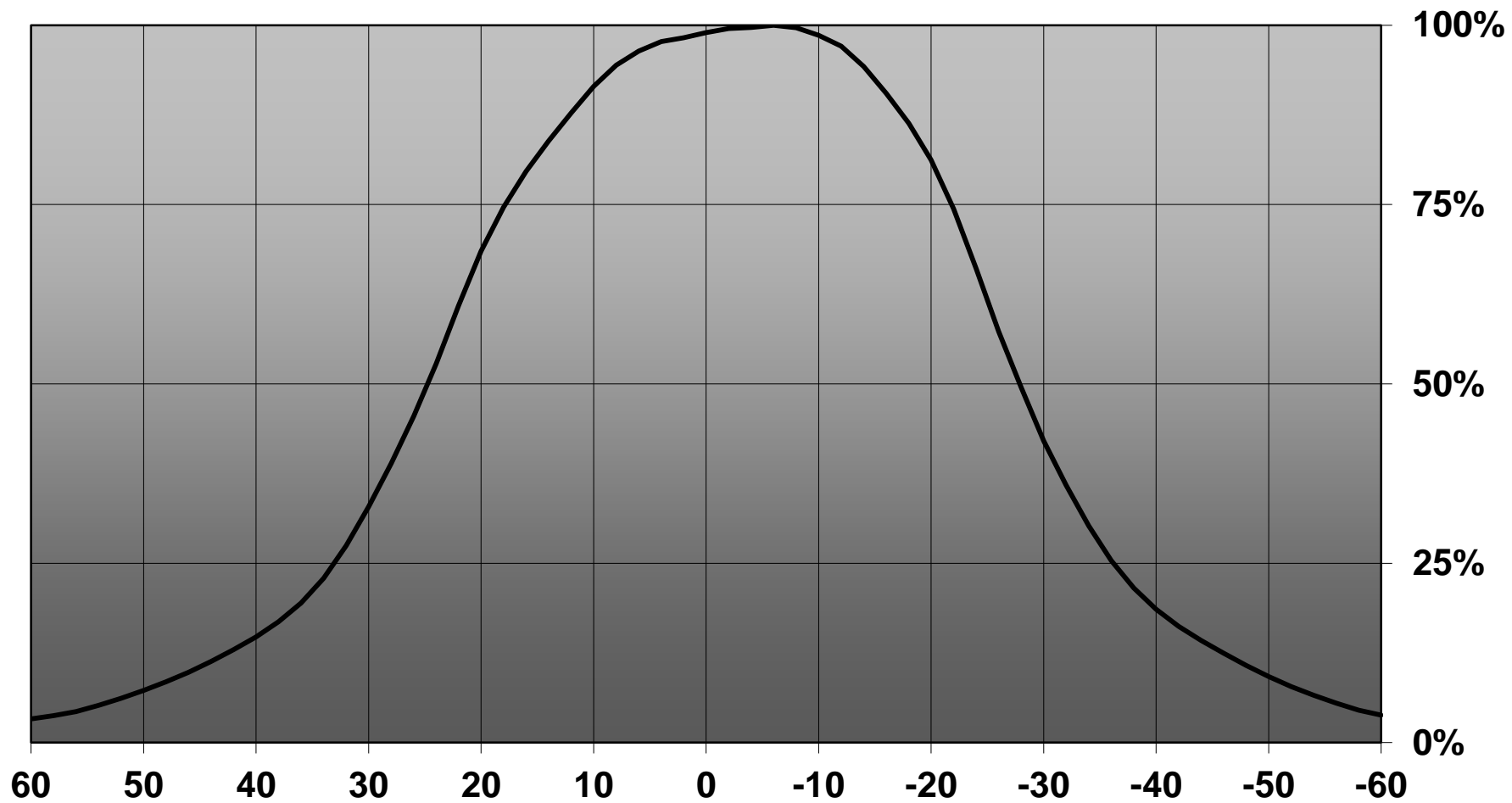

Relative intensity of CN14238_WINNIE-W_(CXA1304)

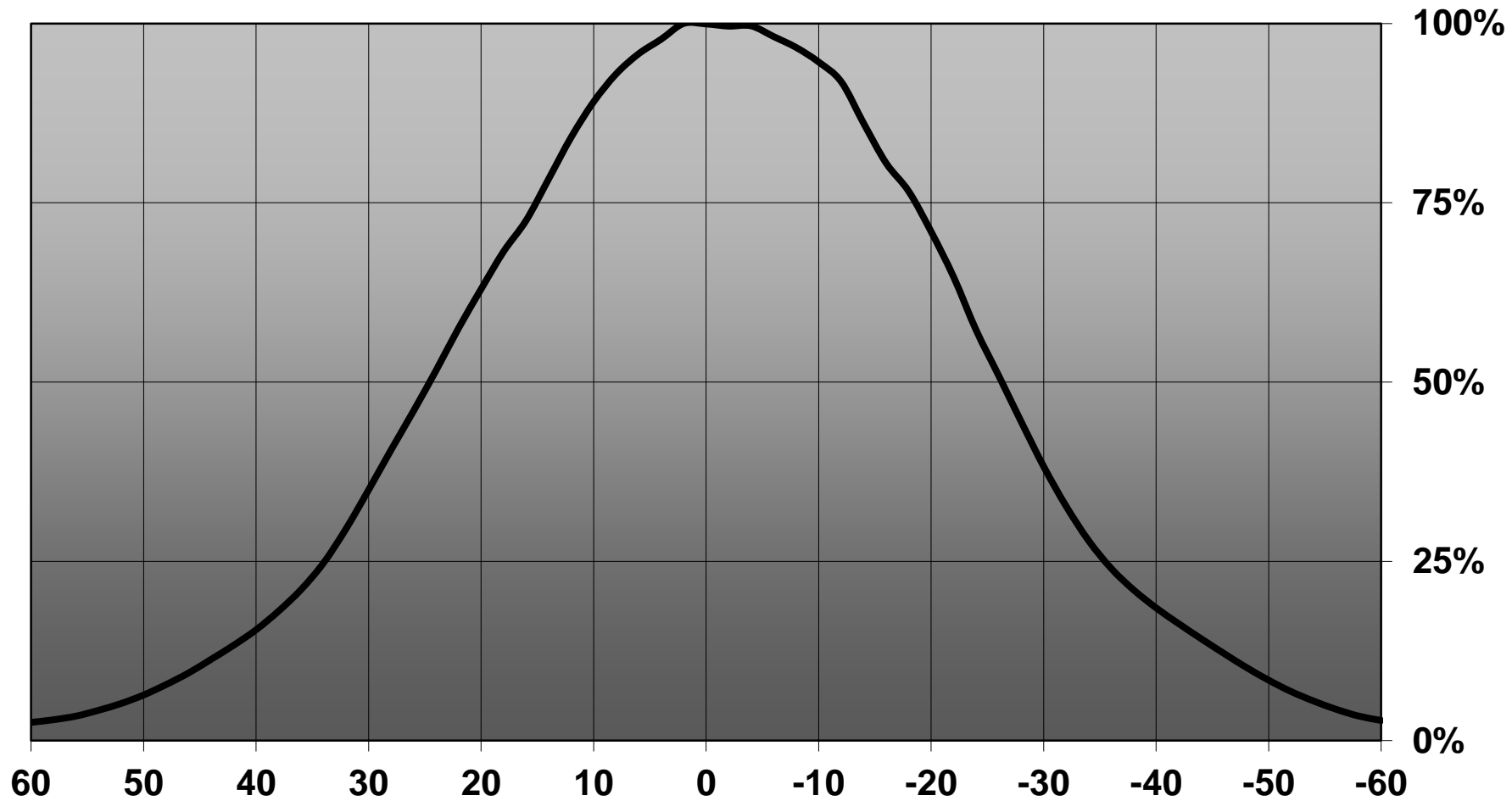

Relative intensity of CN14238_WINNIE-W_(CoB_1202s)

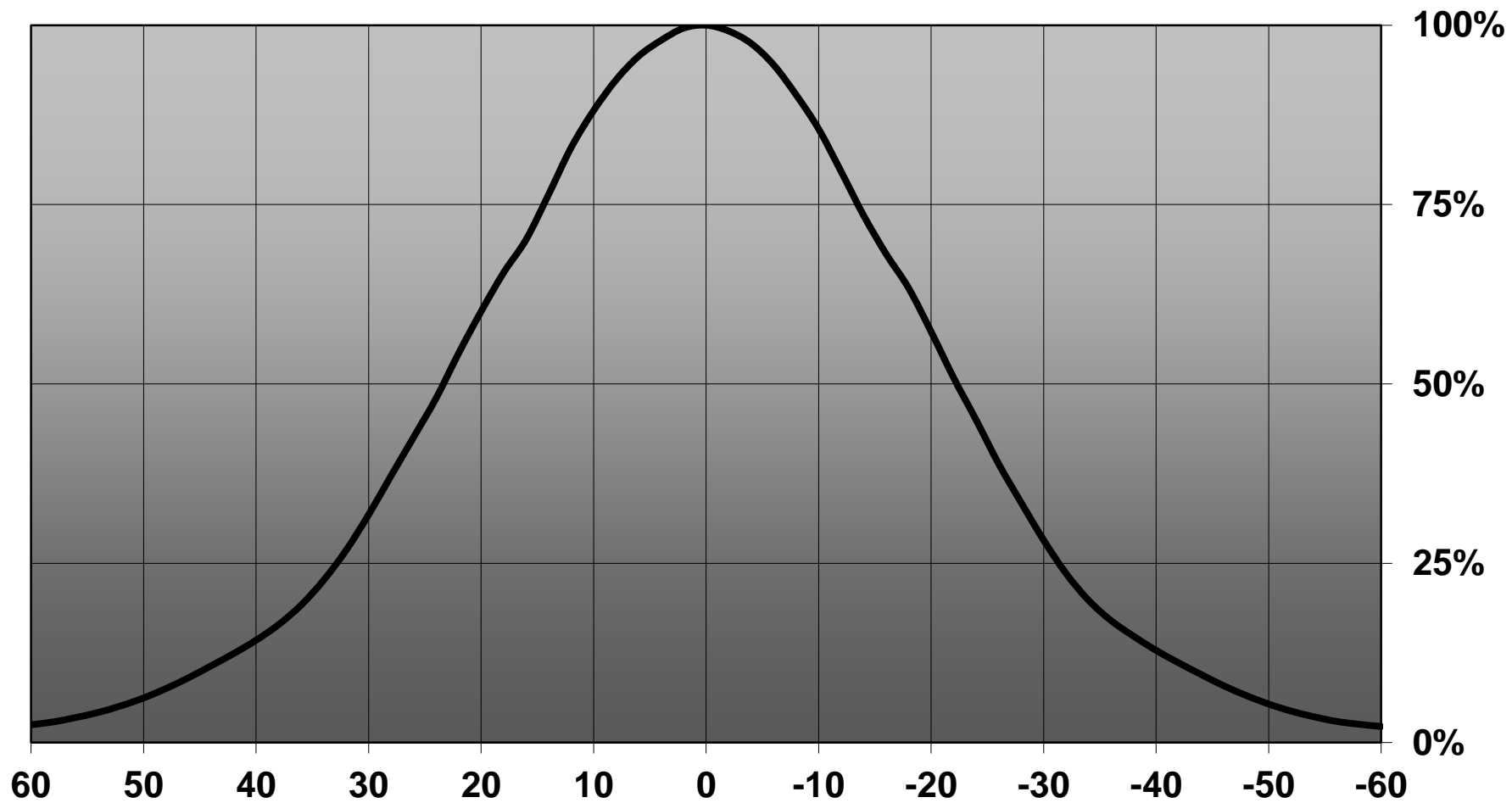

Relative intensity of CN14238_WINNIE-W_(COB_1203)

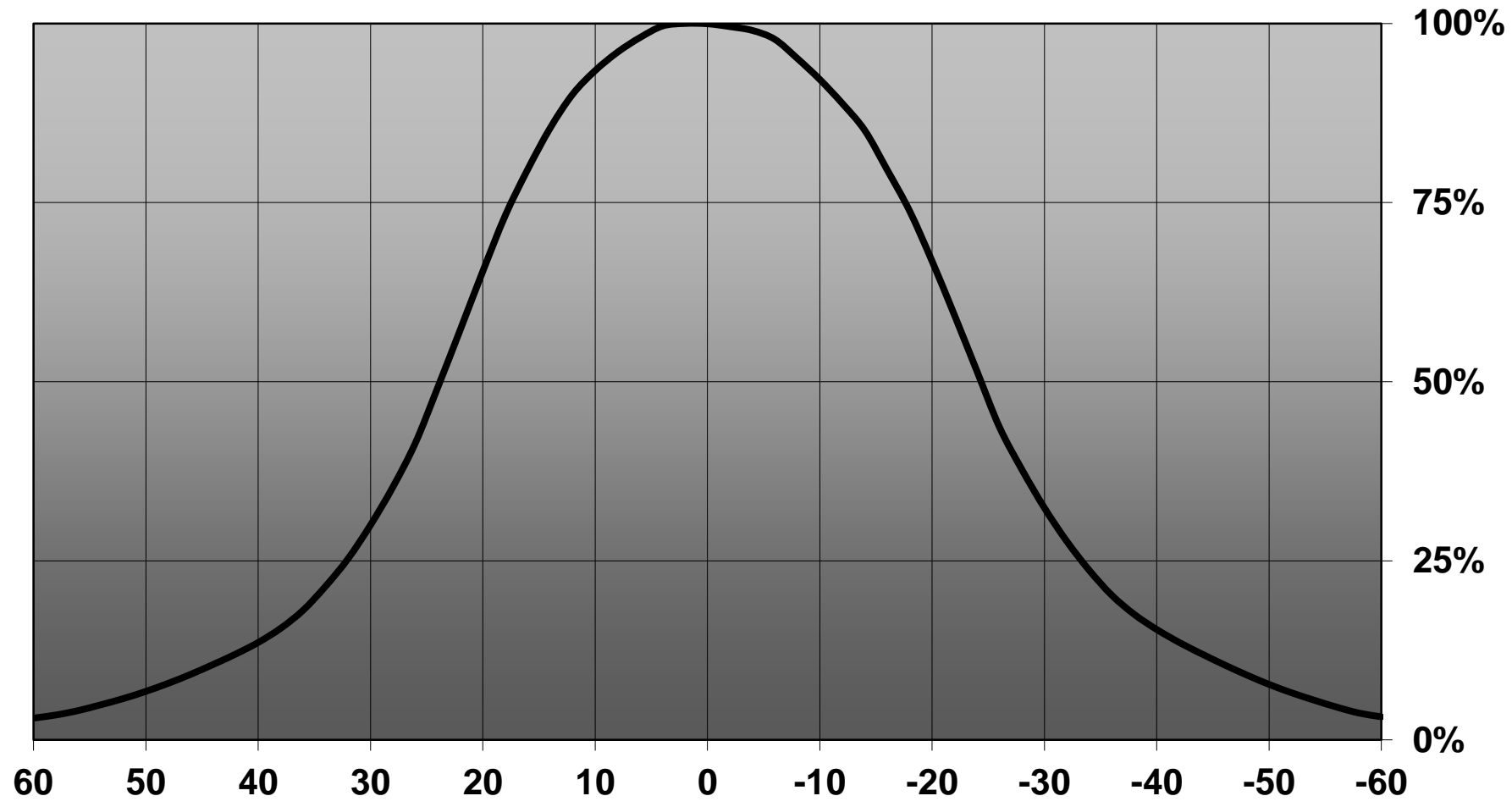

Relative intensity of CN14238_WINNIE-W_(CXM-9)

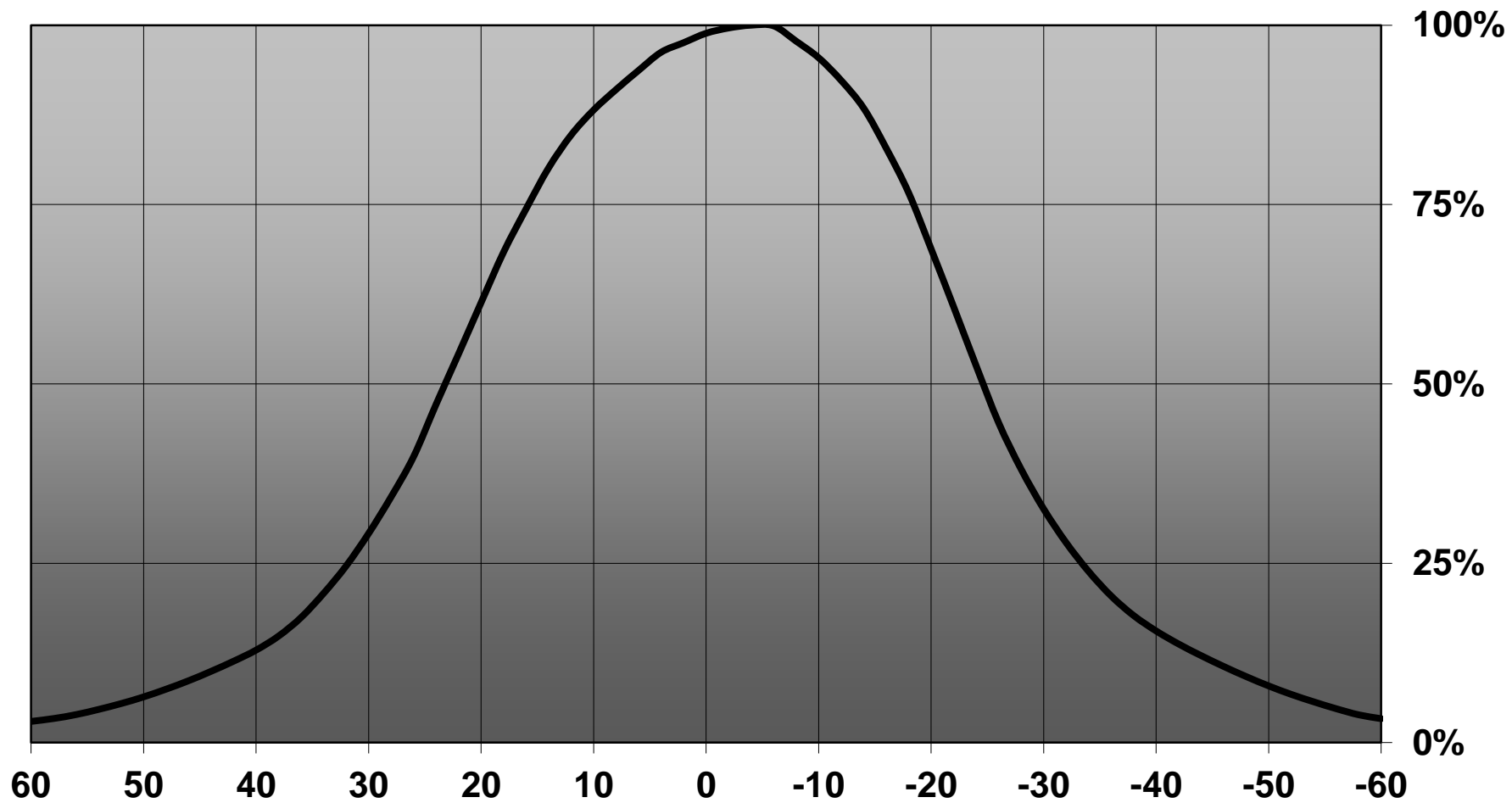

Relative intensity of CN14238_WINNIE-W_(CXM-14)

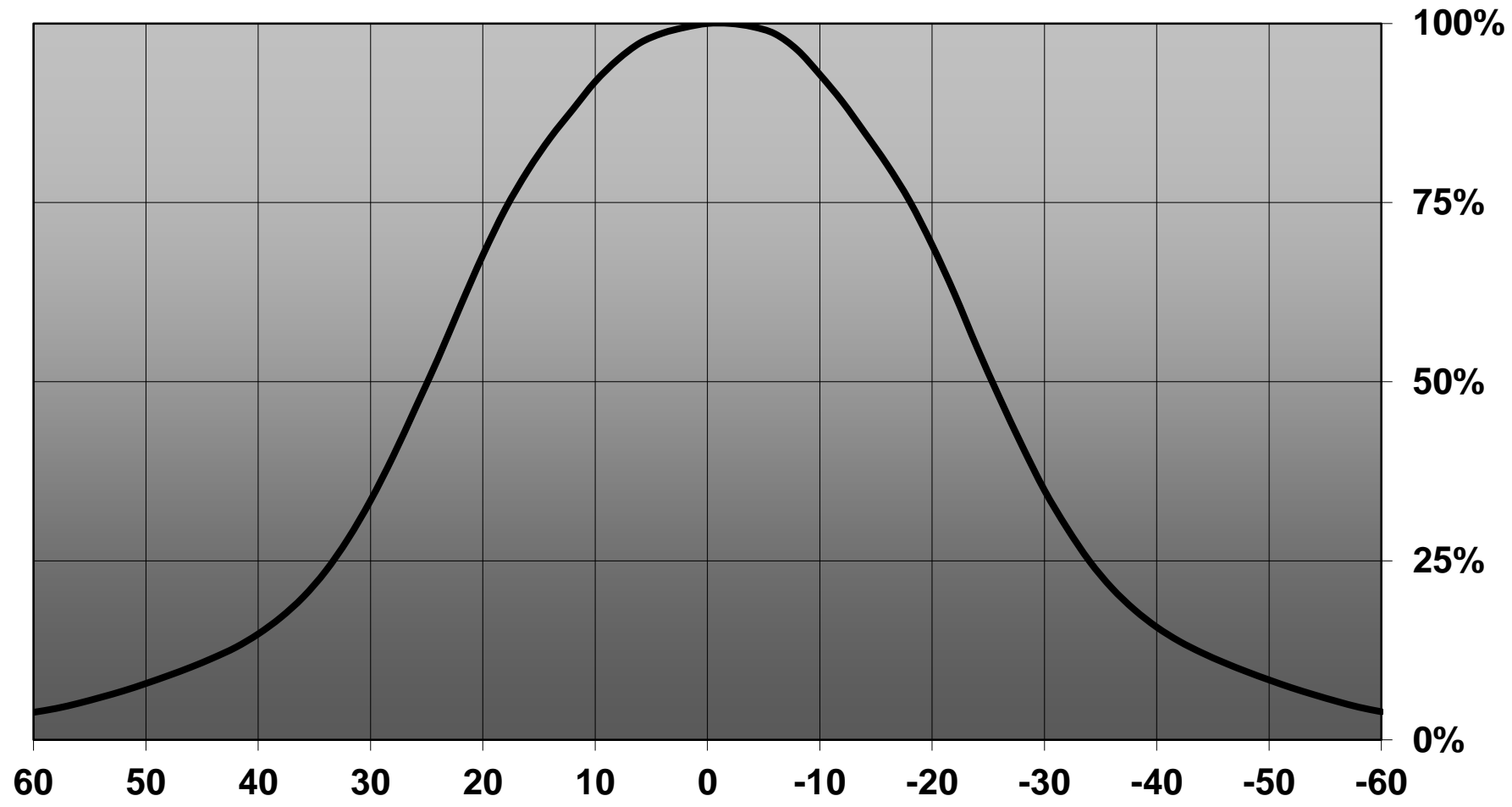

Relative intensity of CN14238_WINNIE-W_(Soleriq_P6)

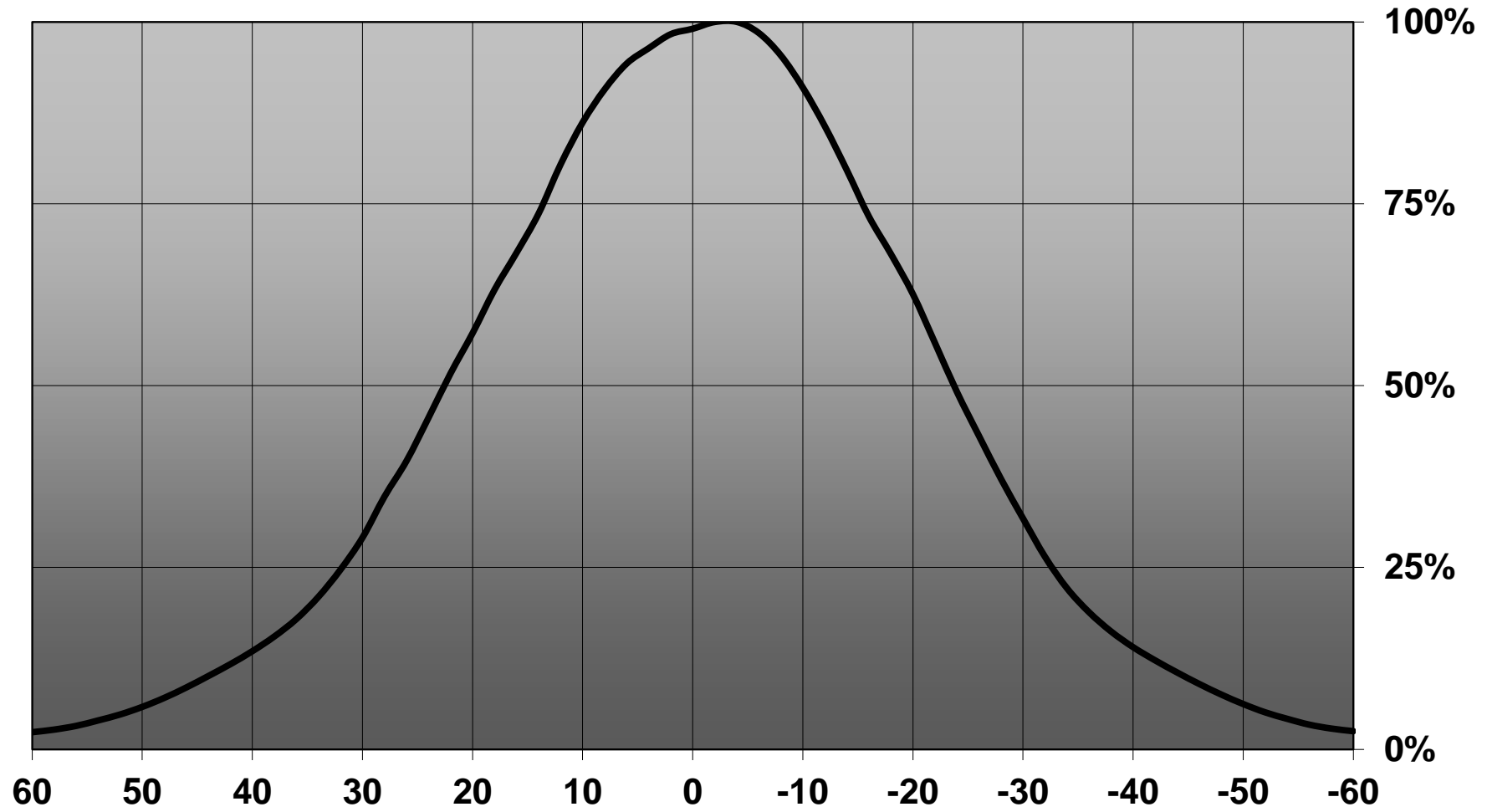

Relative intensity of CN14238_WINNIE-W_(Soleriq_P9)

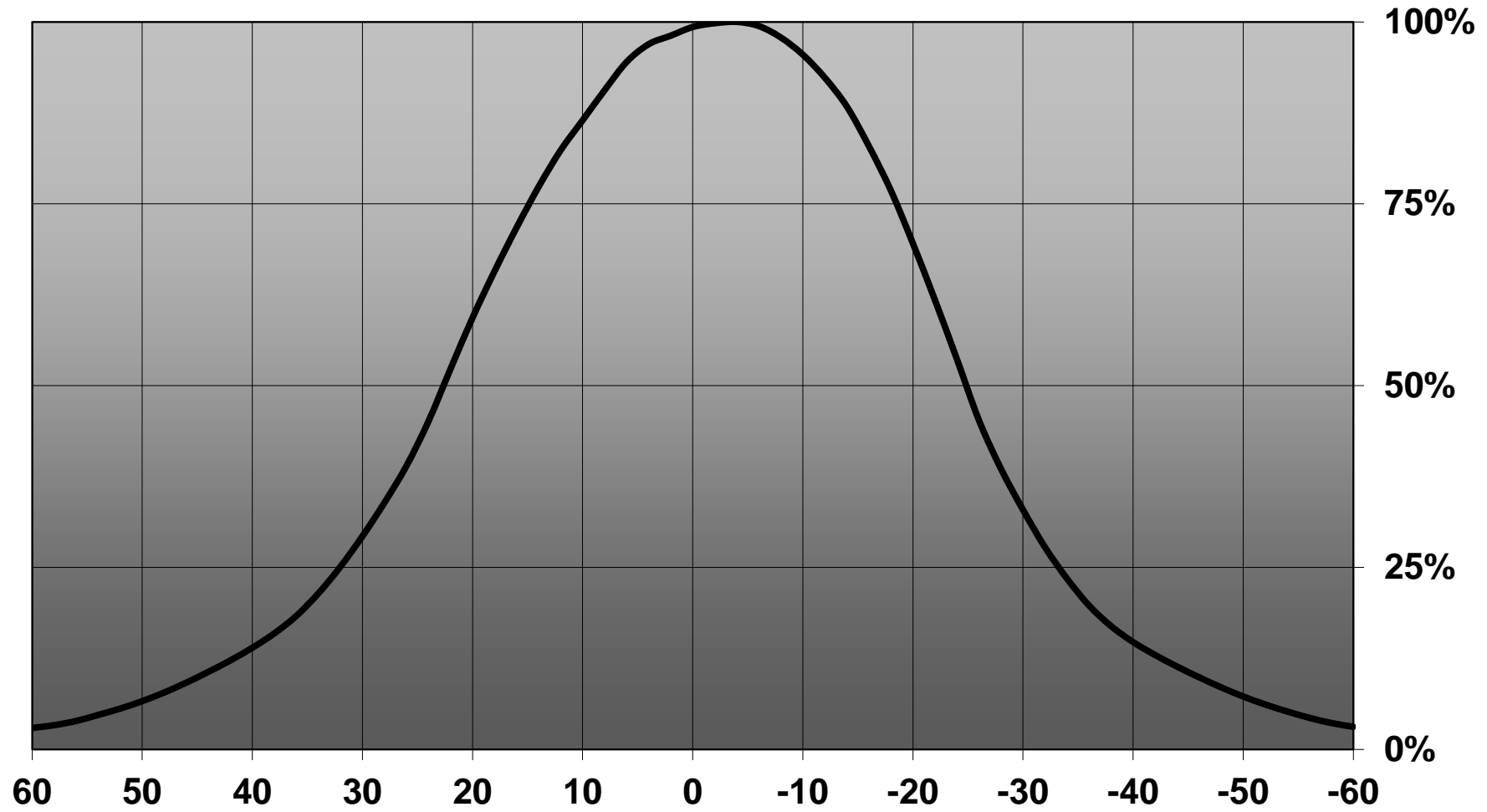

Relative intensity of CN14238_WINNIE-W_(Soleriq_P13)

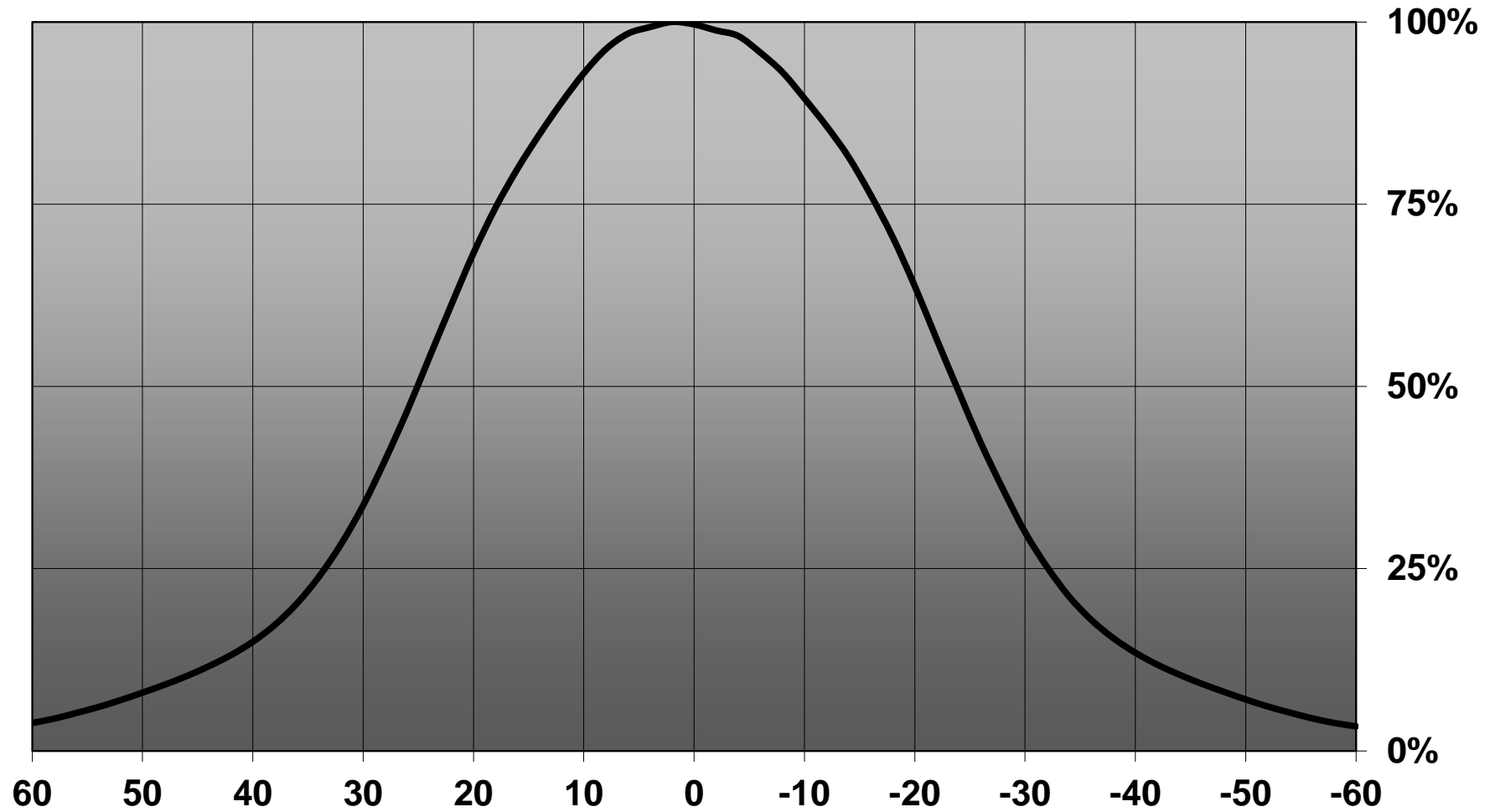

Relative intensity of CN14238_WINNIE-W_(Soleriq_S13)

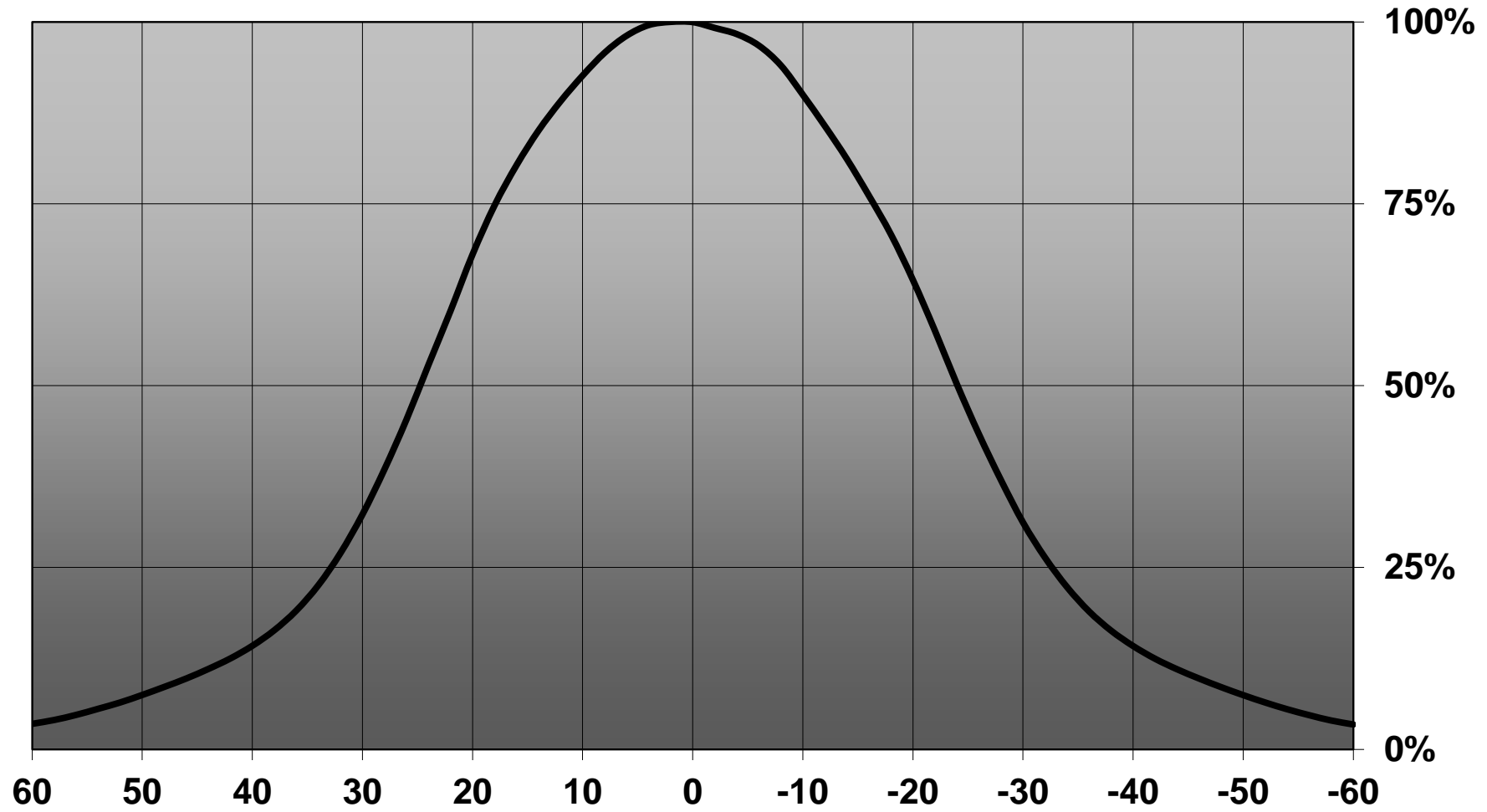

Relative intensity of CN14238_WINNIE-W_(Soleriq_S19)

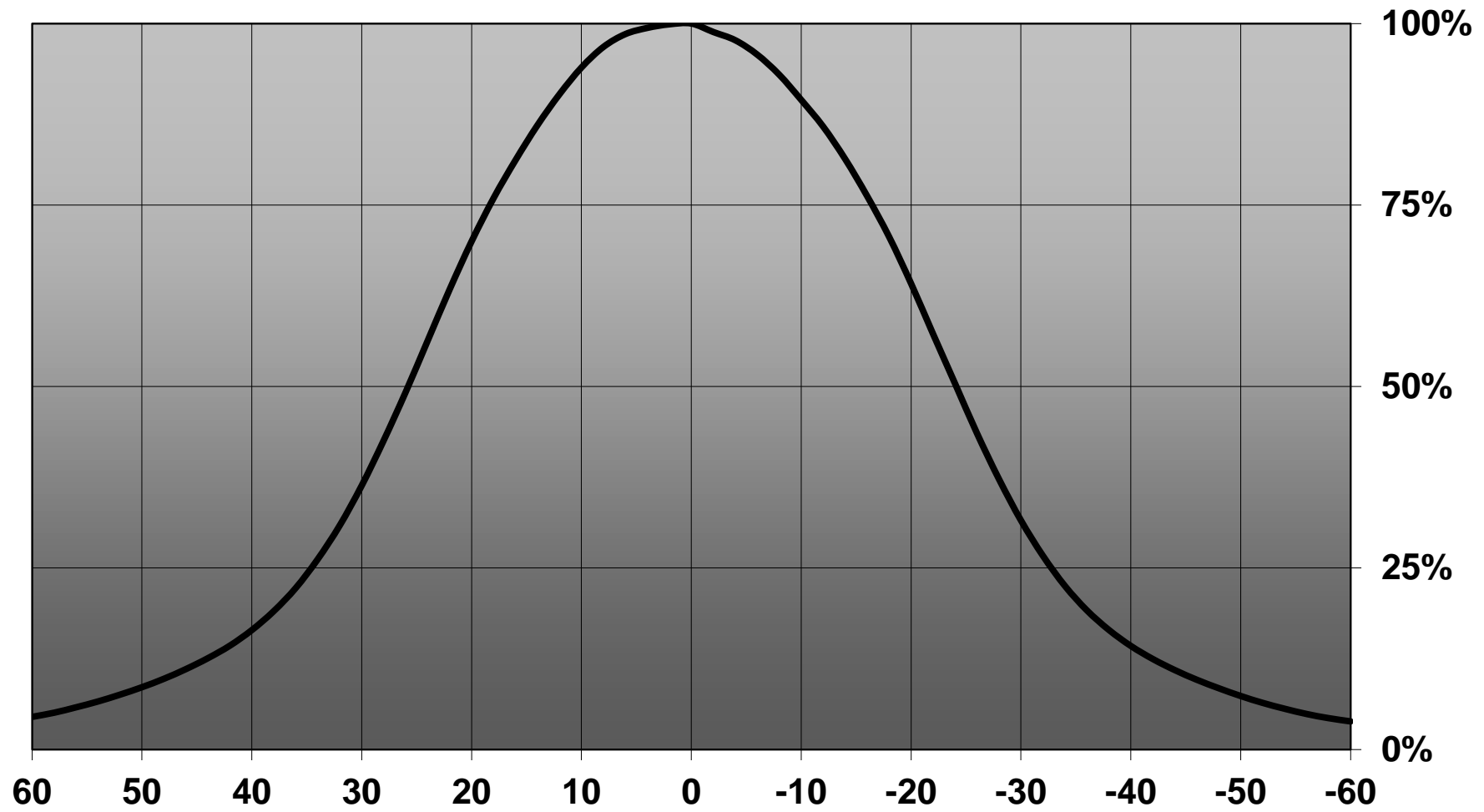

Relative intensity of CN14238_WINNIE-W_(Duris_S10)

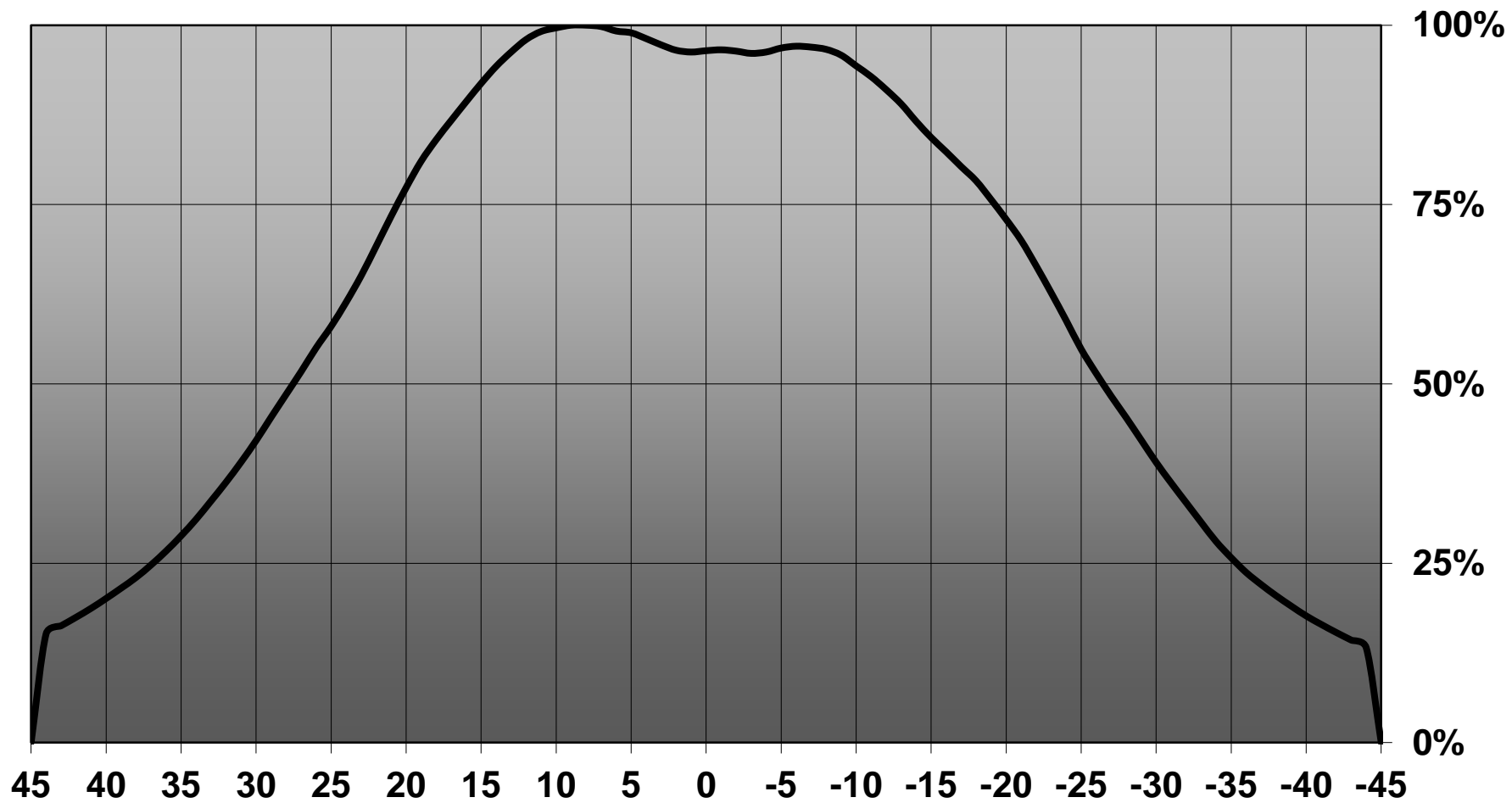

D C B A

4

4

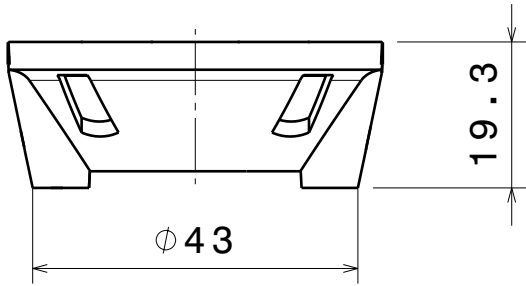

Front view

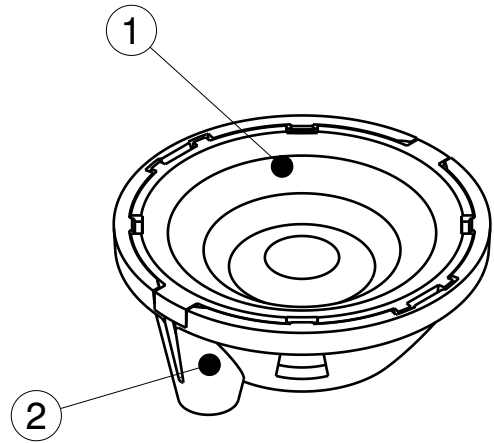

Isometric view

3

3

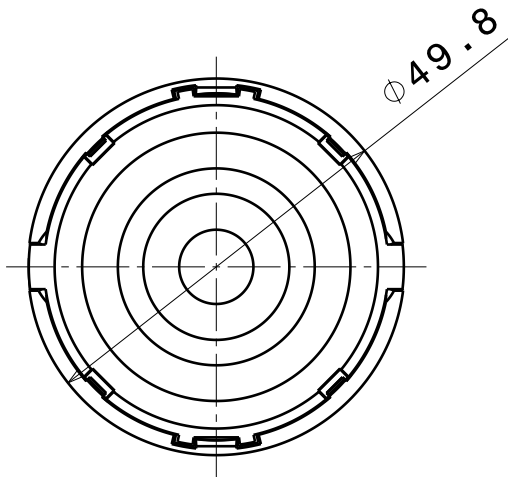

Top view

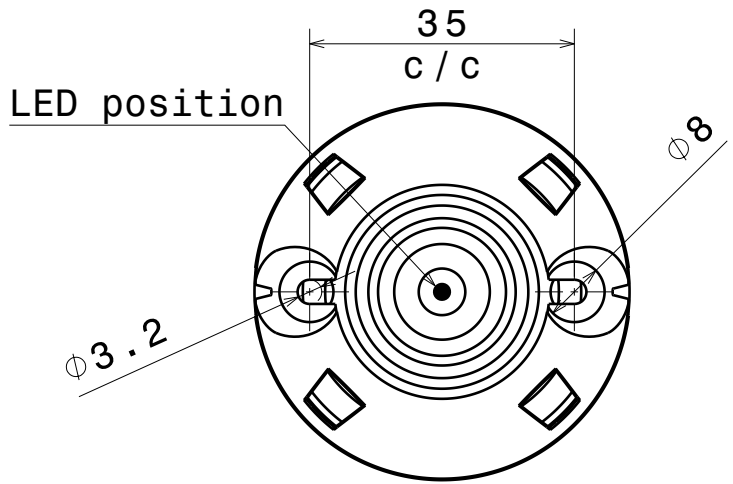

Bottom view

2

2

INDEX	PART NO	DESCRIPTION	MATERIAL	COLOUR
1	C14234	WINNIE-W	PMMA	clear
2	C14235	WINNIE-HOLDER	PC	white

Tolerances if not otherwise shown
According to DIN ISO 2768-1
Linear measures:
Up to 30mm class M, otherwise class C
According to DIN ISO 2768-2
Form and position: class L

LEDiL

Ledil Oy
Salorankatu 10
FIN 24240 SALO
Finland

THIRD ANGLE PROJECTION:

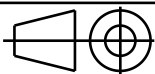

DRAWING TITLE

CN14238_WINNIE-W

This drawing is the property of LEDiL Oy. It may not be reproduced, copied or communicated without a written agreement with LEDiL Oy.

SIZE PART NUMBER

A4

CN14238

SCALE 1:1 WEIGHT 14,82 g SHEET 1/1

1

1

D

A

Luminaire: LEDiL Oy CN14238_WINNIE-W_(VERO10)

Lamps: 1 x Bridgelux_VERO10_(301000B)_758.633lm@250mA_P=6.35346W_I=0.2499A

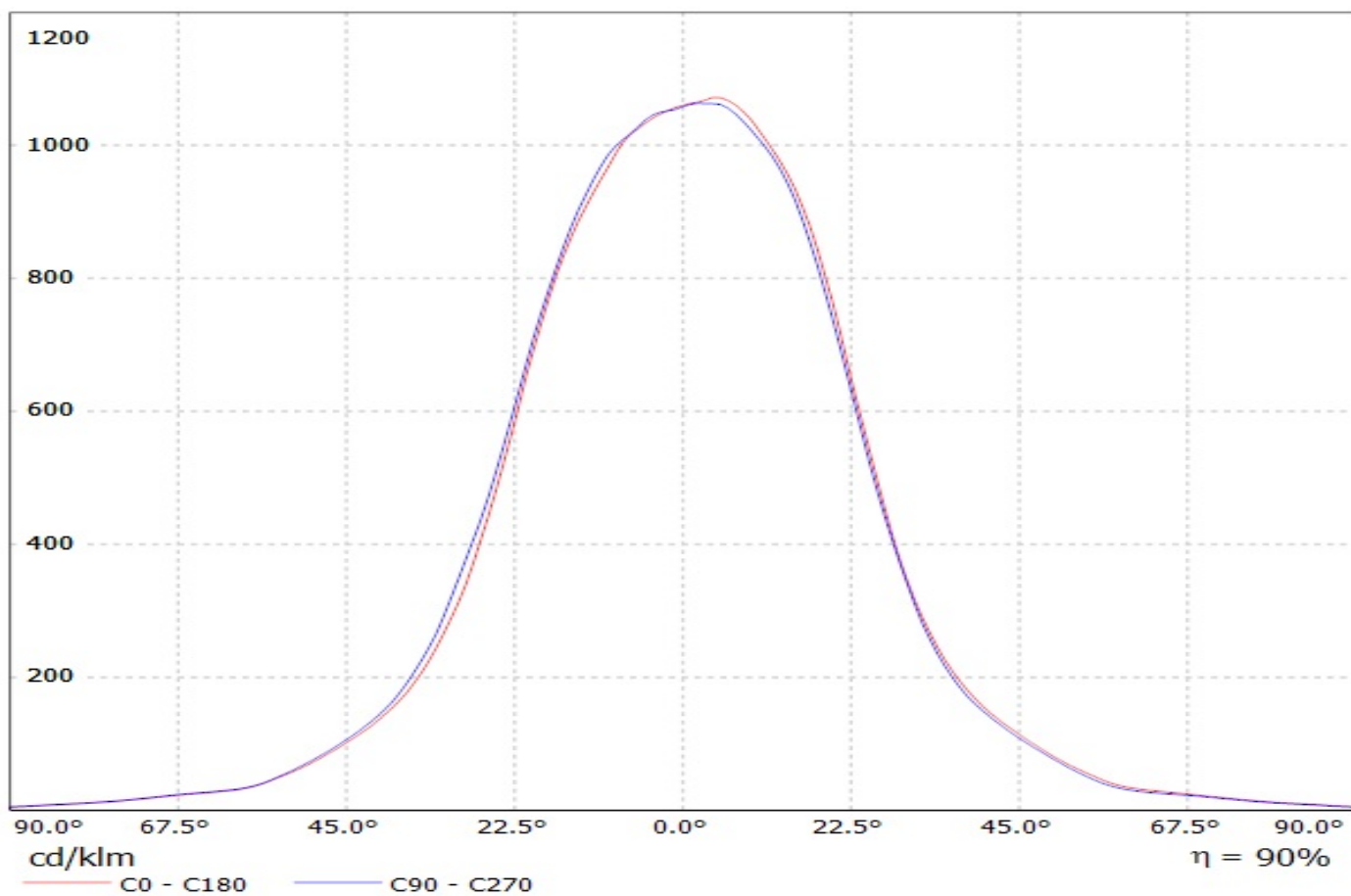

Luminaire: Ledil CN14238_WINNIE-W_(V18)

Lamps: 1 x Bridgelux_V18_(BXRC-30E4000-F-23)_1084.28lm@250mA_P=6.8355W_I=0.250A

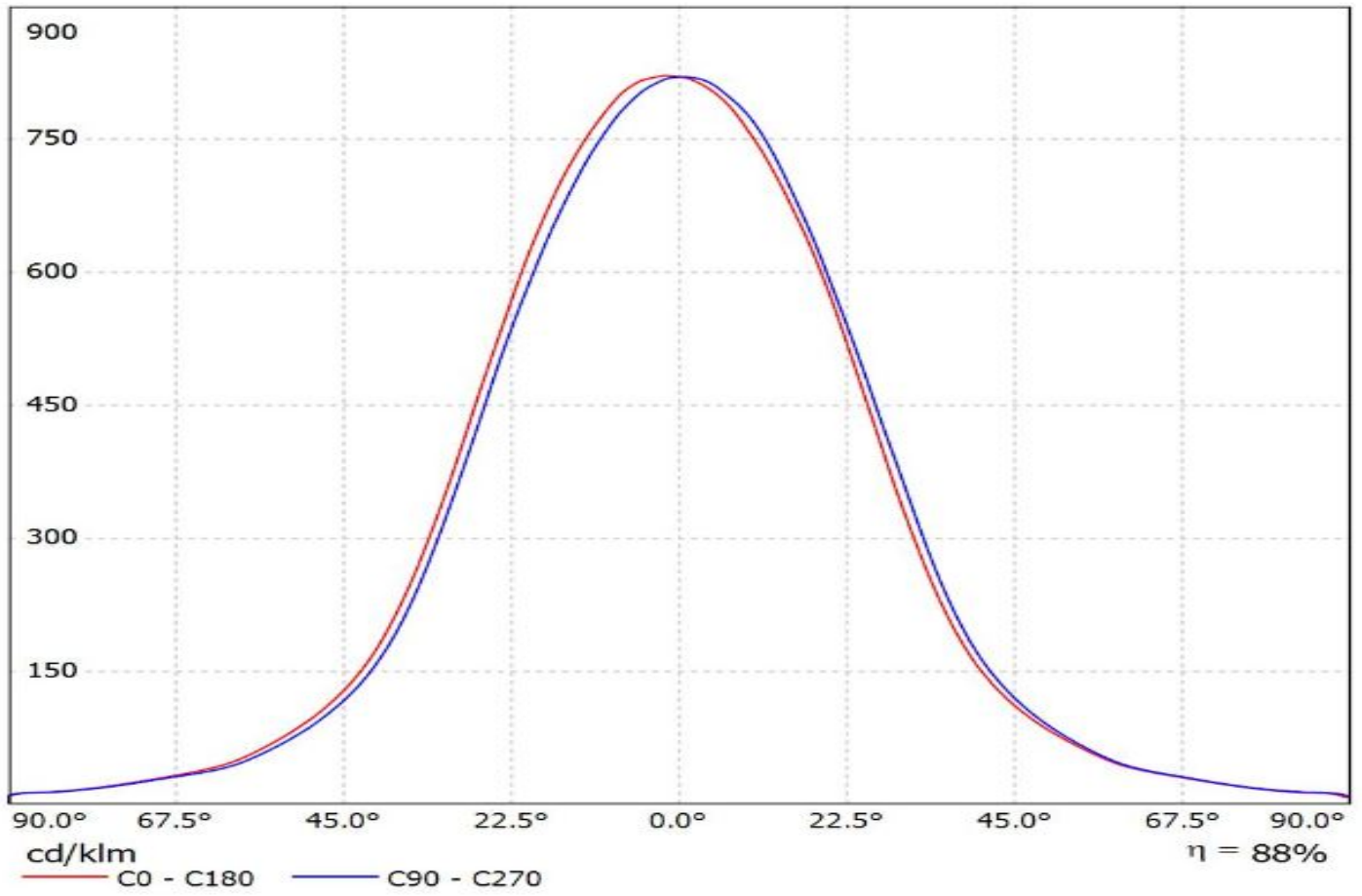

Luminaire: LEDiL Oy CN14238_WINNIE-W_(CLU034)

Lamps: 1 x Citizen_CLU034_(CLL034-1205B8-303M1A2)_+_B+W_433_Typ_L5_1154.06lm@250mA_P=8.45523W_I=250mA

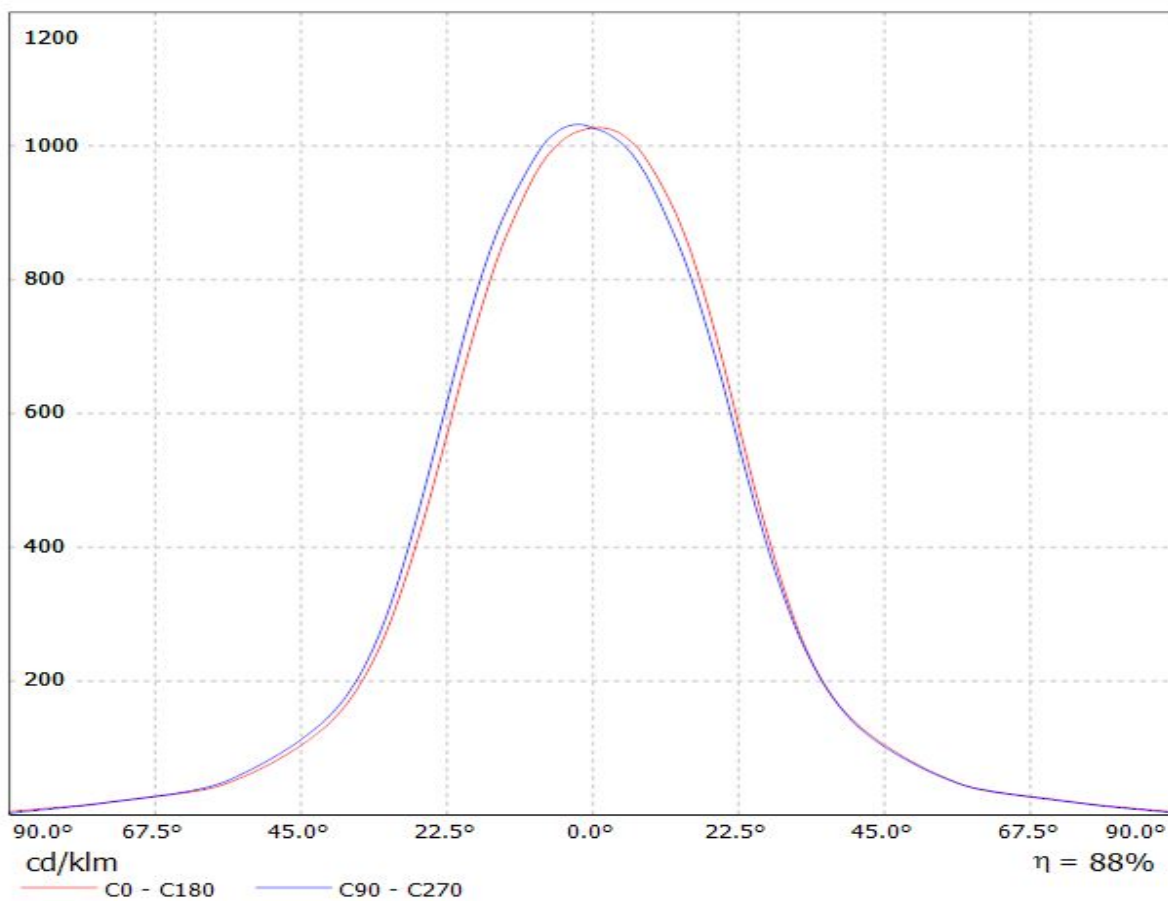

Ledil CN14238_WINNIE-W_(CLU710) / LDC (Linear)

Luminaire: Ledil CN14238_WINNIE-W_(CLU710)

Lamps: 1 x CITIZEN_CLU710_(CLU710-1204B8-273M2G1)_1210.56lm@250mA_P=8.5W_I=0.25A

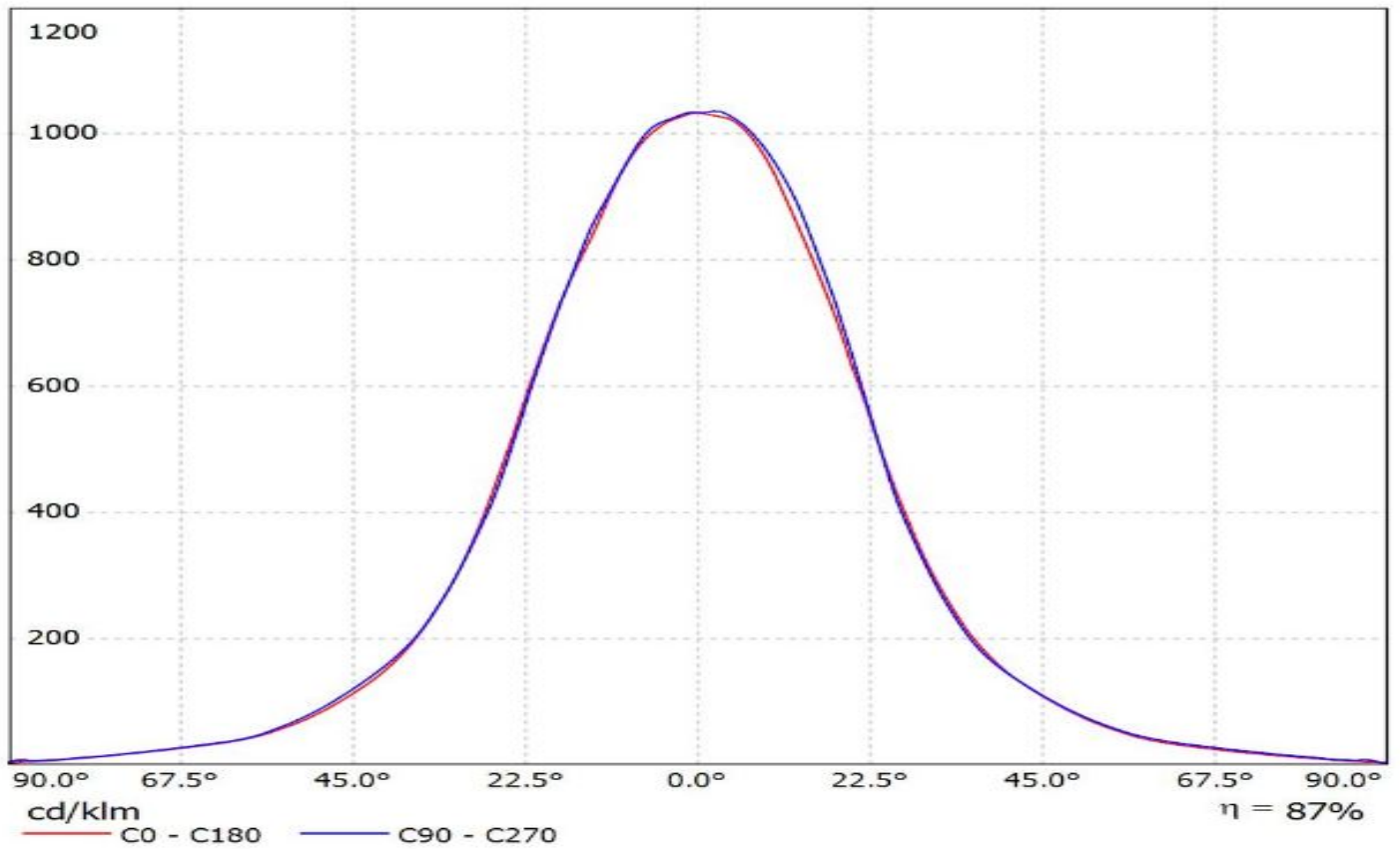

Luminaire: LEDiL Oy CN14238_WINNIE-W_(CLU024)_434-Typ-L5

Lamps: 1 x Citizen_CLU-024_(CLU024-1204B8-303M1A2)_434-Typ-L5_1023.5lm@250mA_P=8.57963W_I=0.2498A

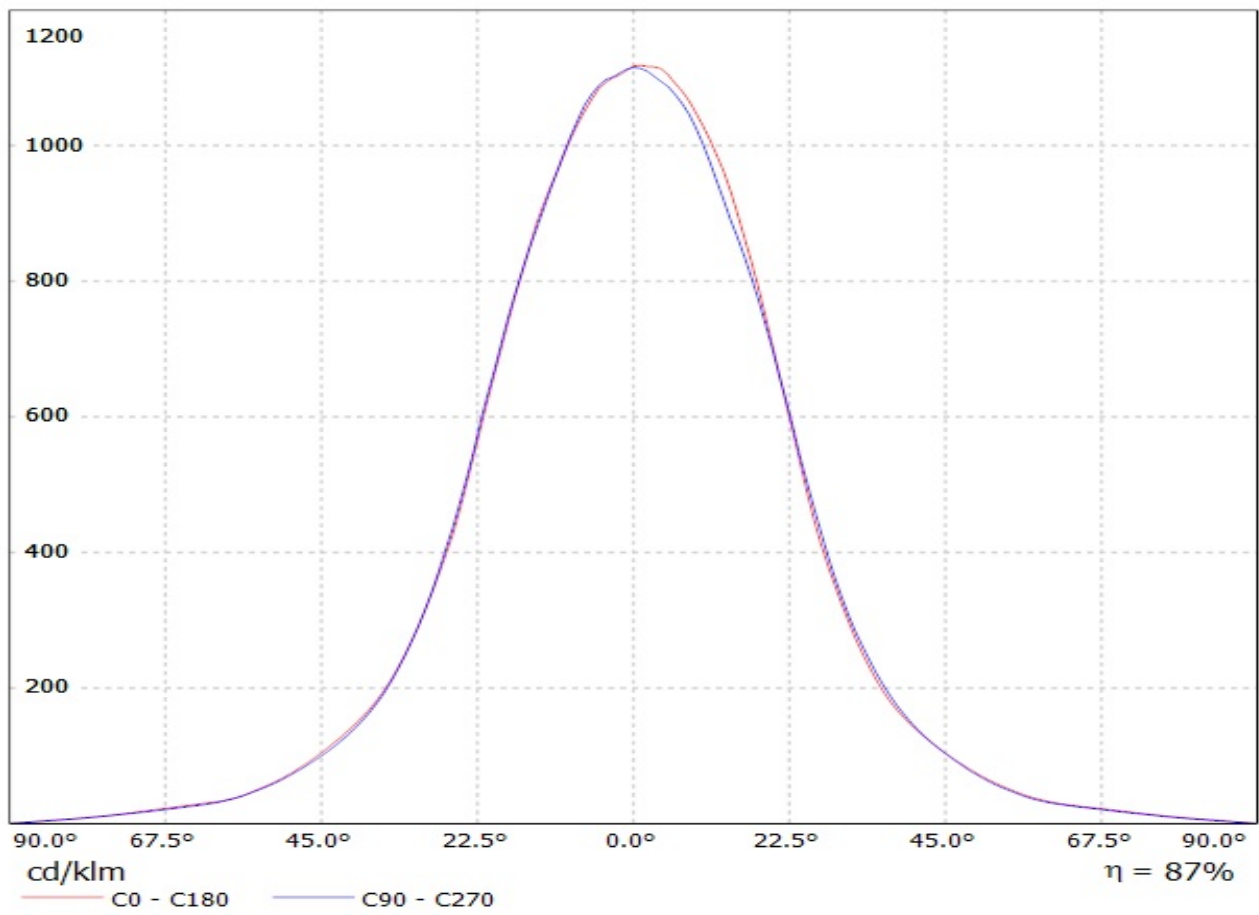

Luminaire: LEDiL Oy CN14238_WINNIE-W_(CLU700)_434-Typ-L5

Lamps: 1 x Citizen_CLU700_(CLU700-1002B8-273M2G1)_434_Typ_L5_377.008lm@100mA_P=2.82212W_I=0.1001A

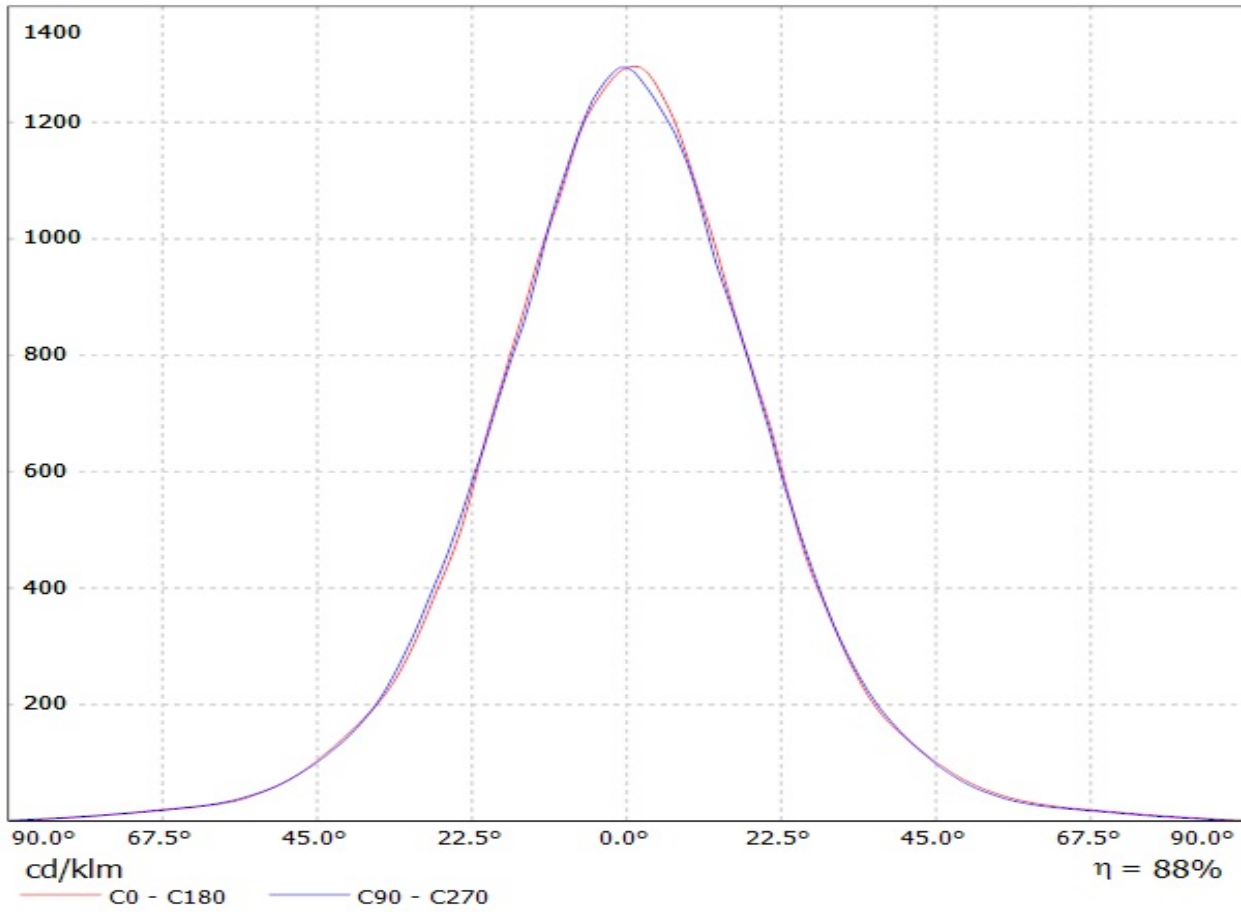

Ledil CN14238_WINNIE-W_(CLU720) / LDC (Linear)

Luminaire: Ledil CN14238_WINNIE-W_(CLU720)

Lamps: 1 x Citizen_CLU720_(CLU720-1206B8-273M2G1)_1253.68lm@250mA_P=8.3W_I=0.25A

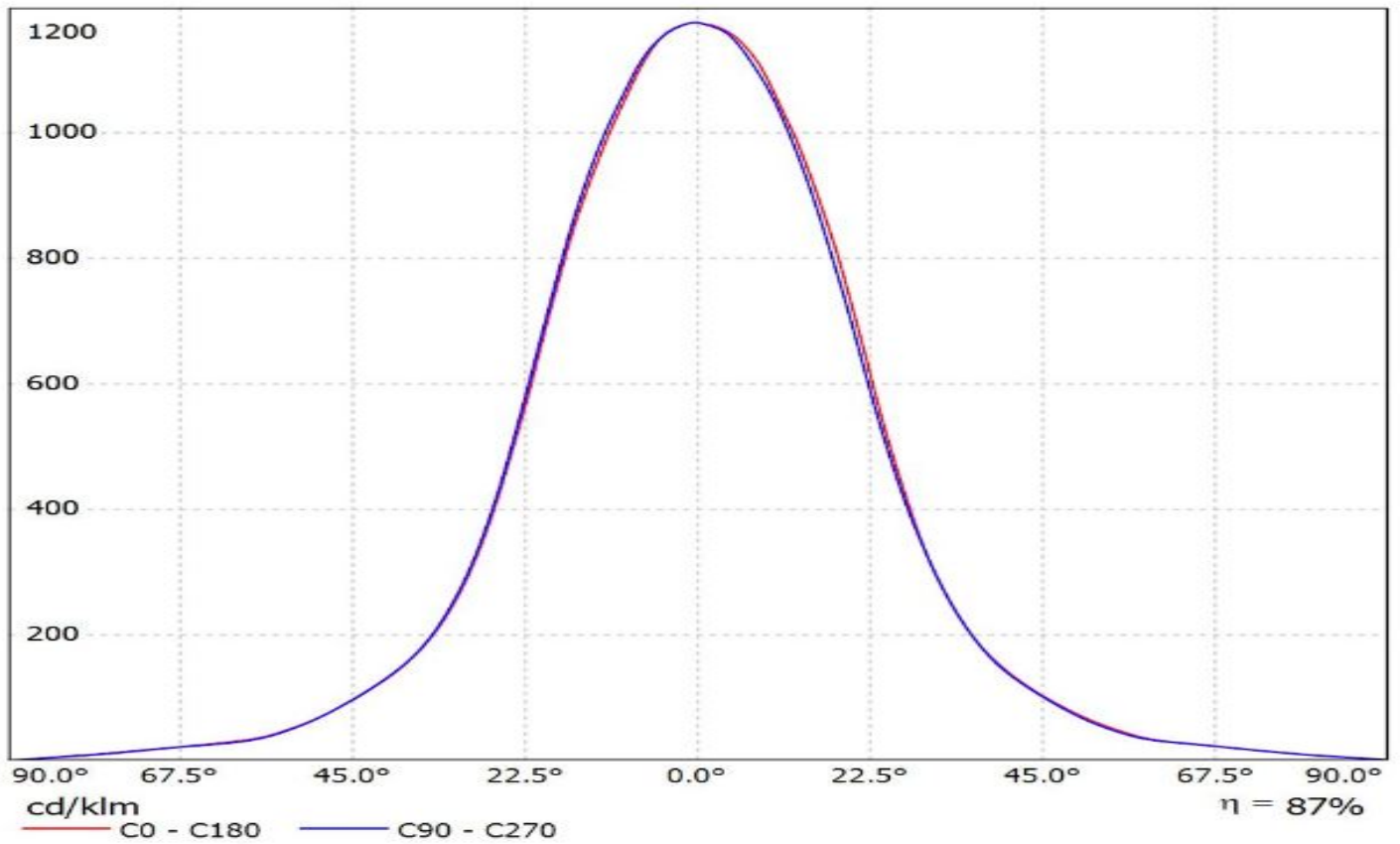

Luminaire: LEDiL Oy CN14238_WINNIE-W_(CLU700)

Lamps: 1 x Citizen_CLU700_367.467lm@100mA_P=2.77574W_I=0.1002A

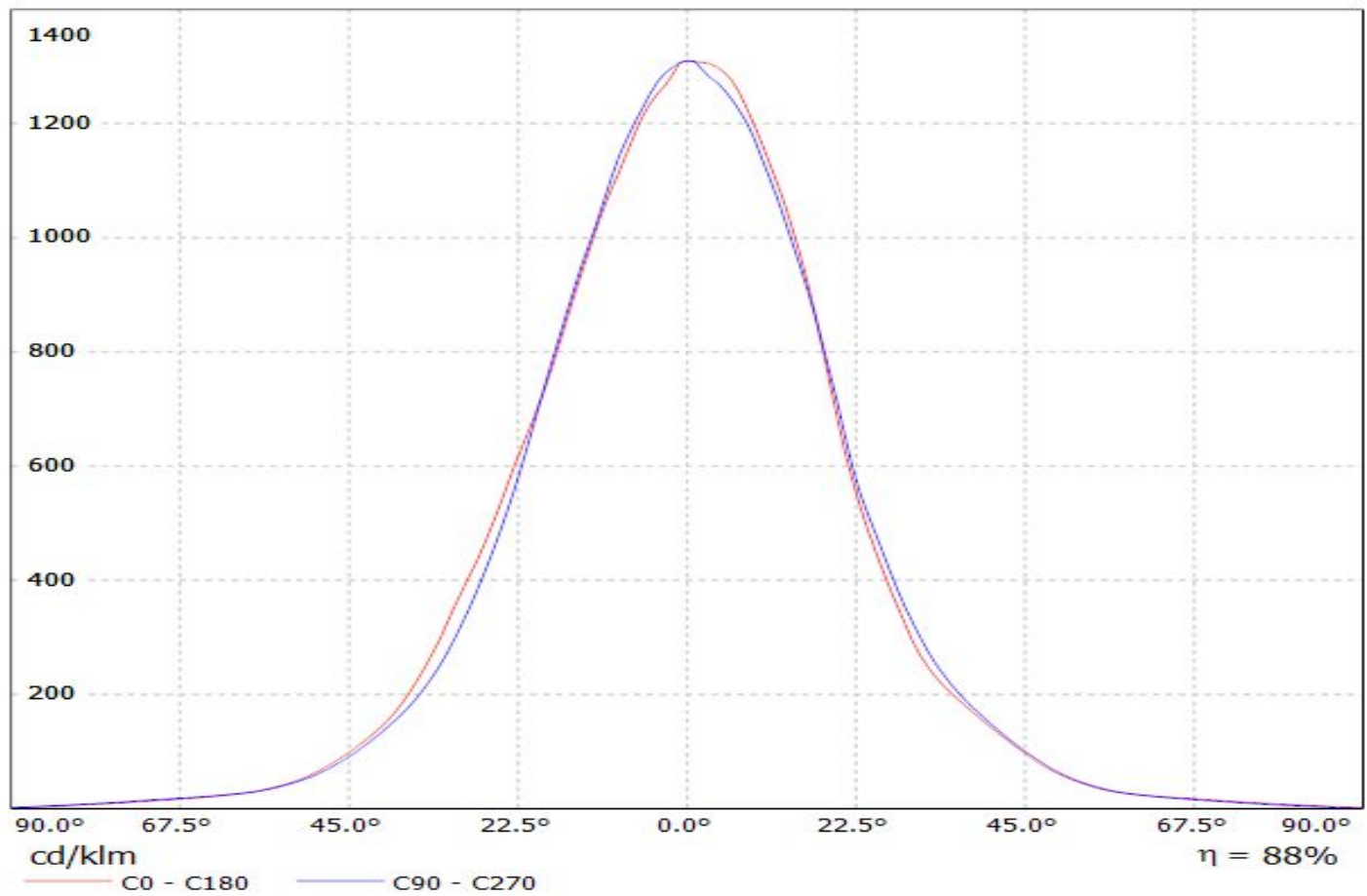

Ledil CN14238_WINNIE-W_(CLU710)_(470_Typ_L5) / LDC (Linear)

Luminaire: Ledil CN14238_WINNIE-W_(CLU710)_(470_Typ_L5)
Lamps: 1 x Citizen_CLU710_(CLU710-1204B8-273M2G1)_(470_Typ_L5)
_1134.69lm@250mA_CCT=2700K_P=8.5W_I=0.25A

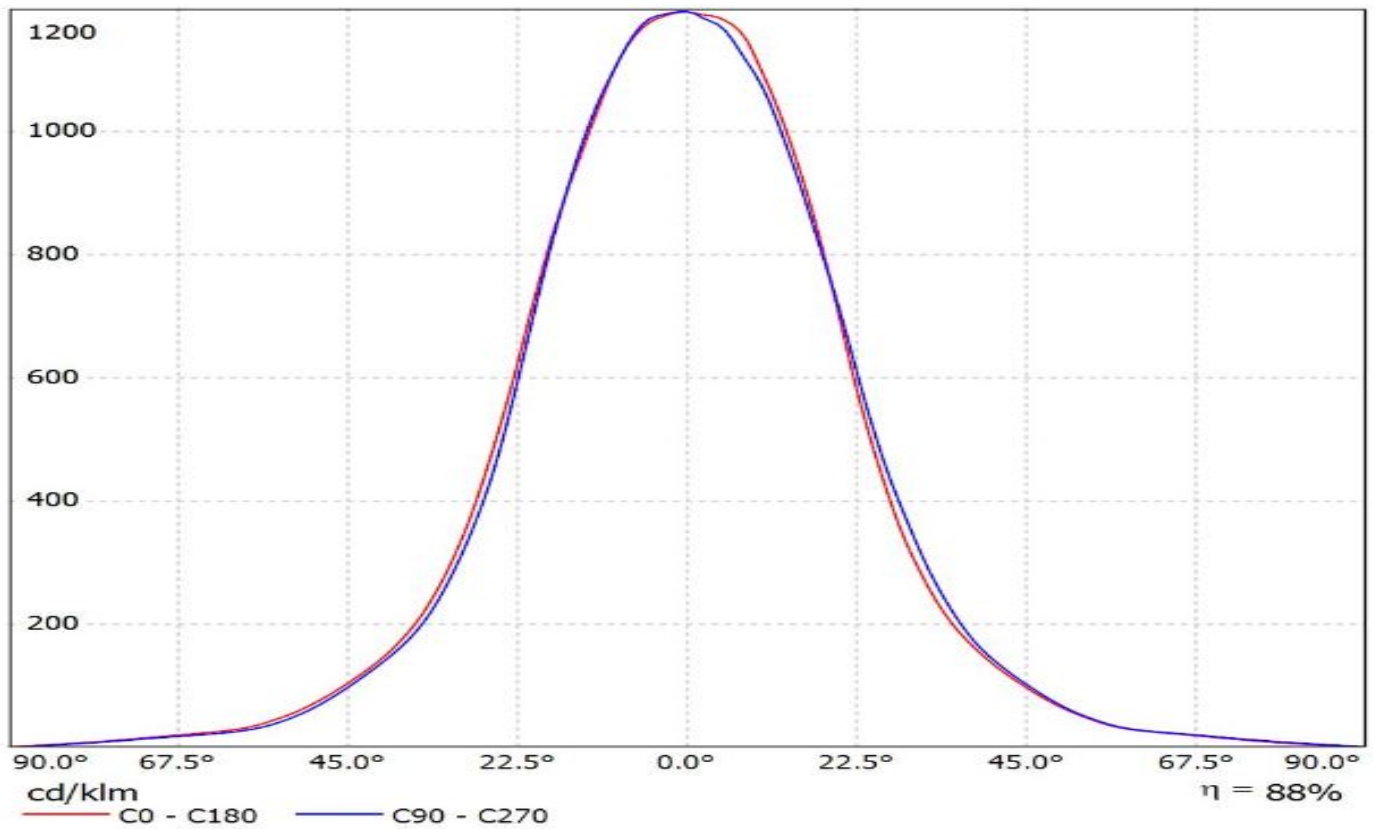

Luminaire: Ledil CN14238_WINNIE-W_(MHD-G)
Lamps: 1 x Cree MHD-G_530.44lm@100mA_P=3.0W_I=0.100A

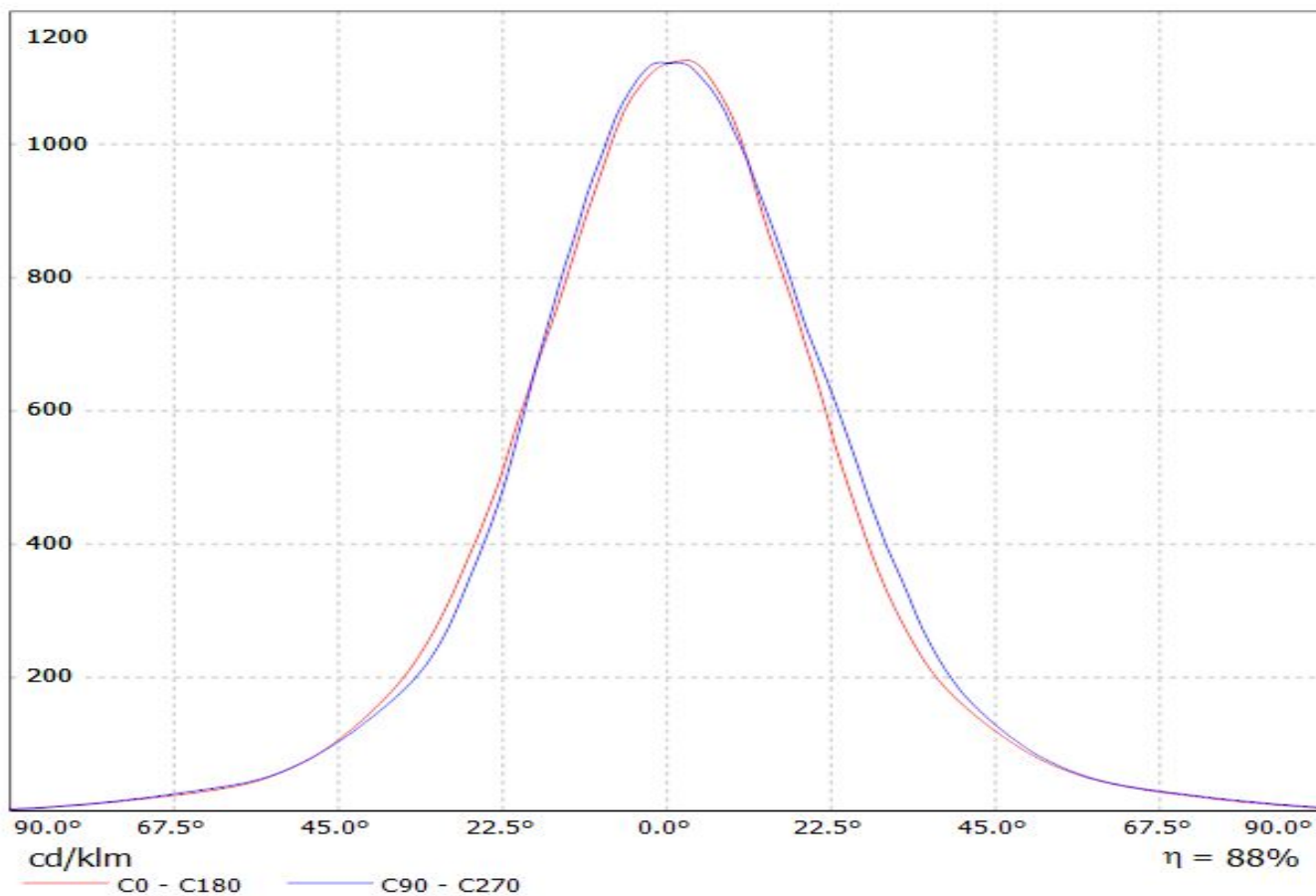

Luminaire: Ledil Oy CN14238_WINNIE-W_(Soleriq_S9)_SIMULATED
Lamps: 1 x Osram Soleriq S9 (GW KAFJB3.EM)

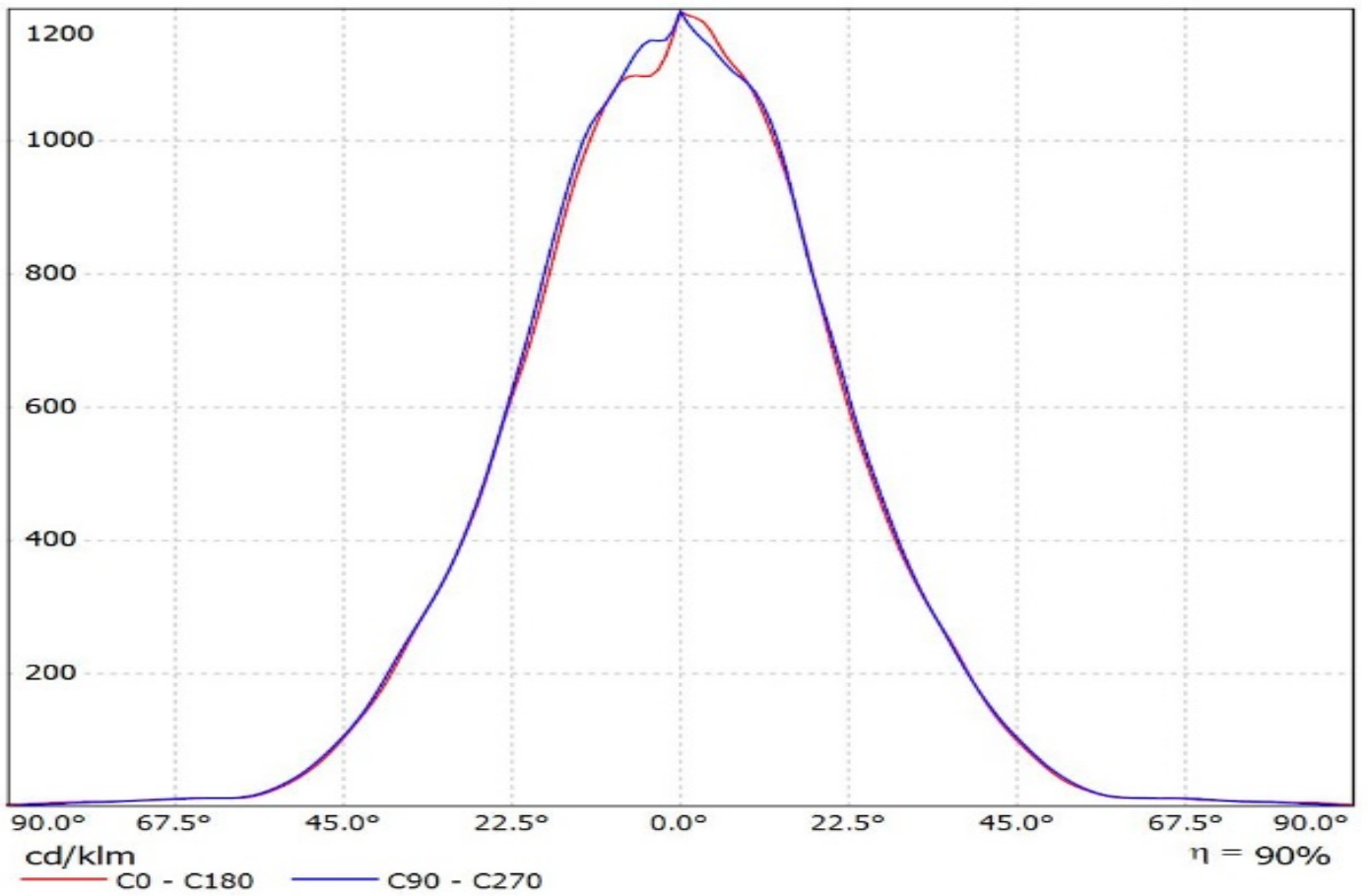

Luminaire: Ledil Oy CN14238_WINNIE-W_(LC010C)_ (479_type_L5)_SIMULATED
Lamps: 1 x Samsung LC101C + Bender & Wirth 479 Type L5

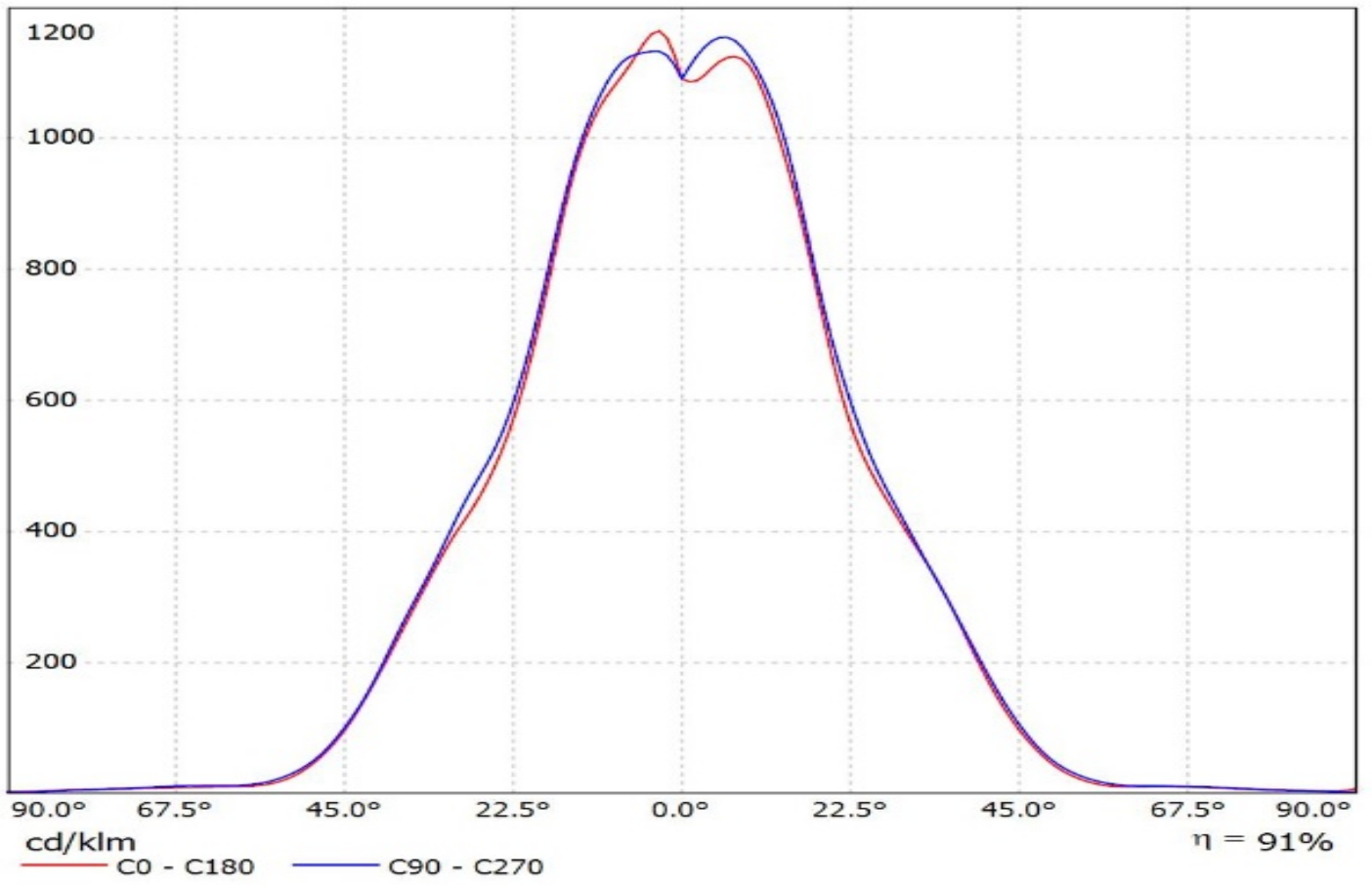

Luminaire: Ledil Oy CN14238_WINNIE-W_(LC020C)_(B+W_479_Typ_L5)_SIMULATED
Lamps: 1 x Samsung LC020C

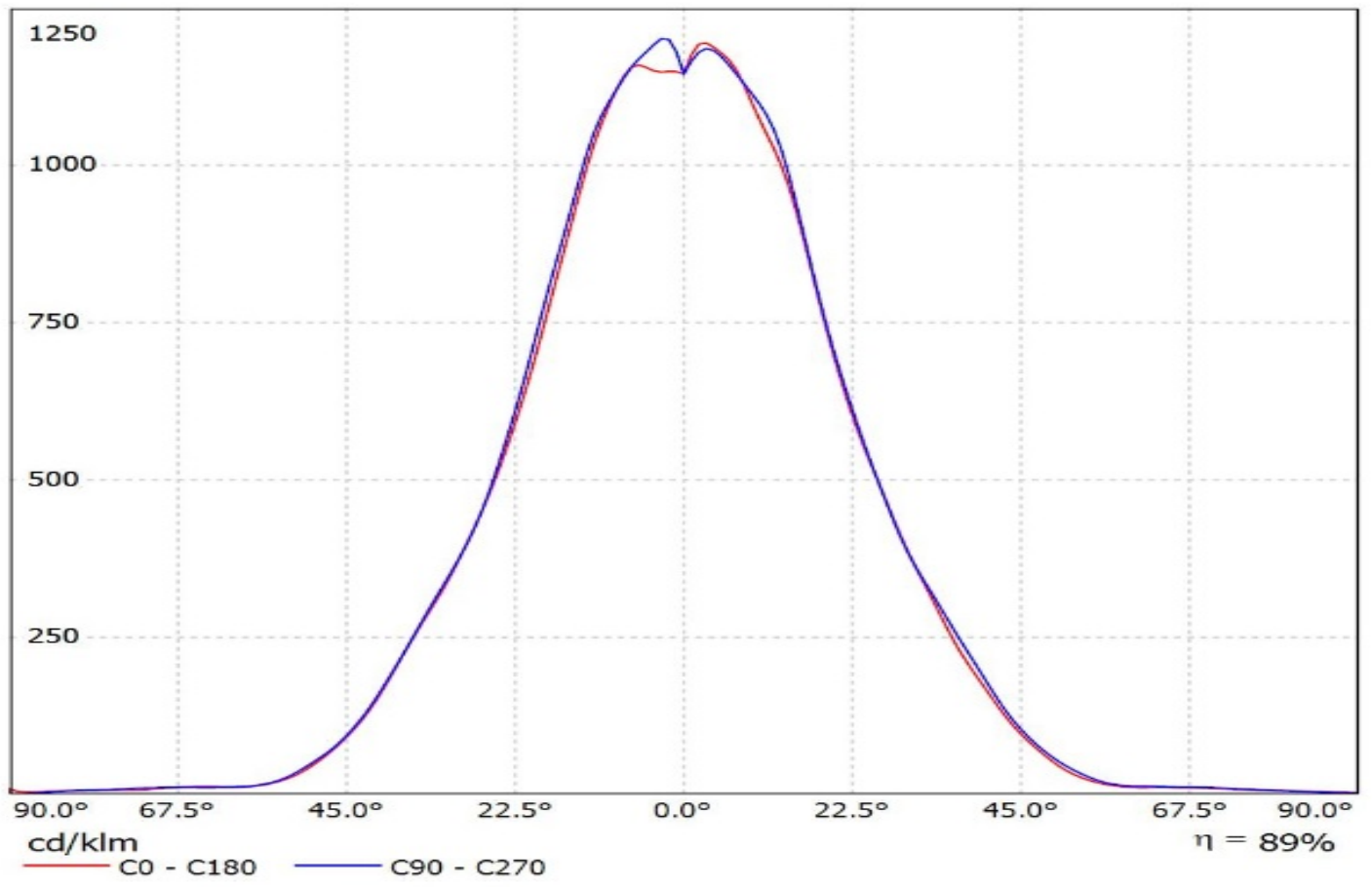

Luminaire: Ledil Oy CN14238_WINNIE-W_(LC040C)_(B+W_479_Typ_L5)_SIMULATED
Lamps: 1 x Samsung LC040C

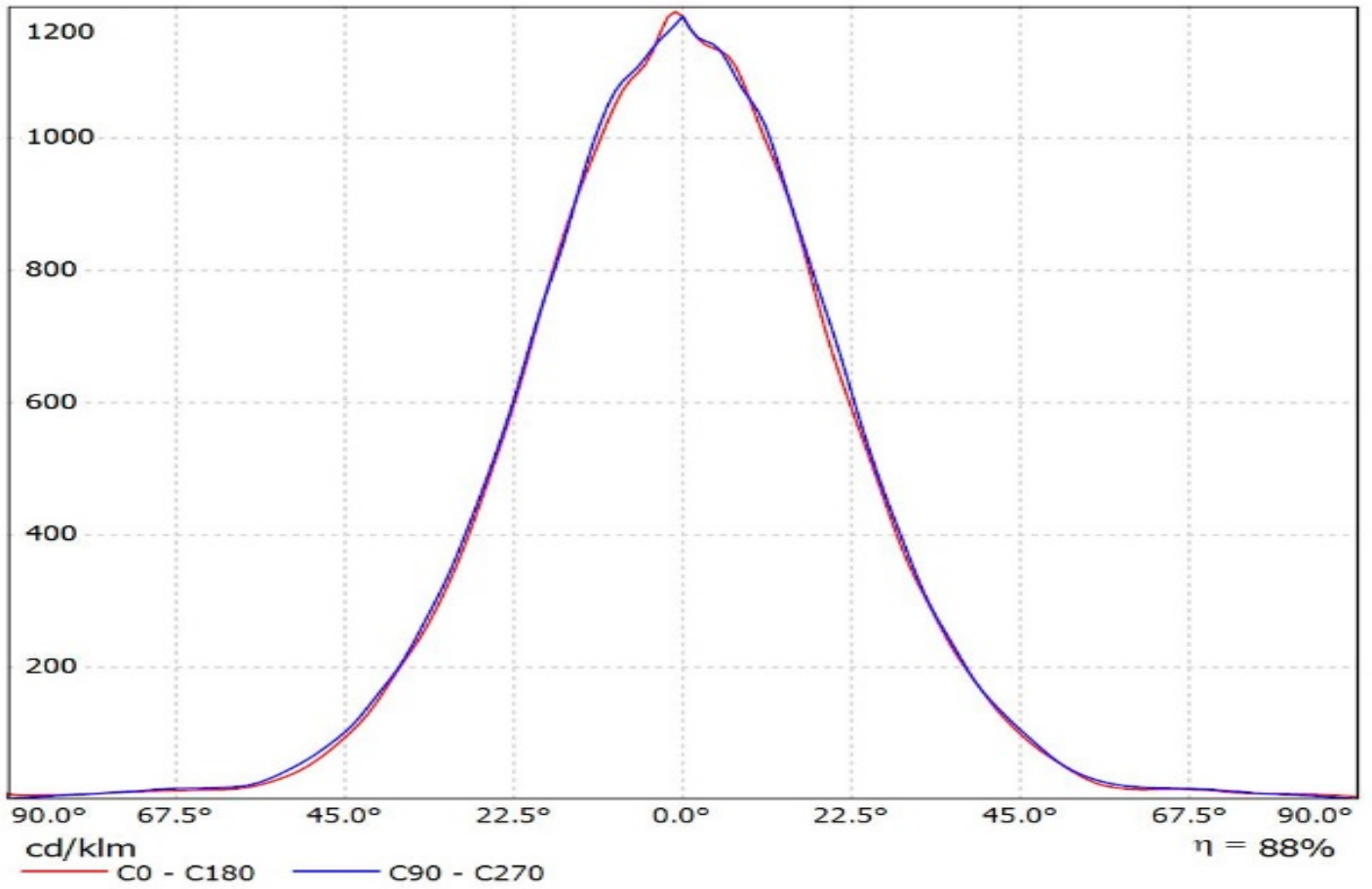

Luminaire: LEDiL Oy CN14238_WINNIE-W_(COB_D_series_LES_9.8mm)

Lamps: 1 x Samsung_COB_D_series_LES_9.8mm_LC013D_551.044lm@100mA_P=3.2212W_I=0.100A

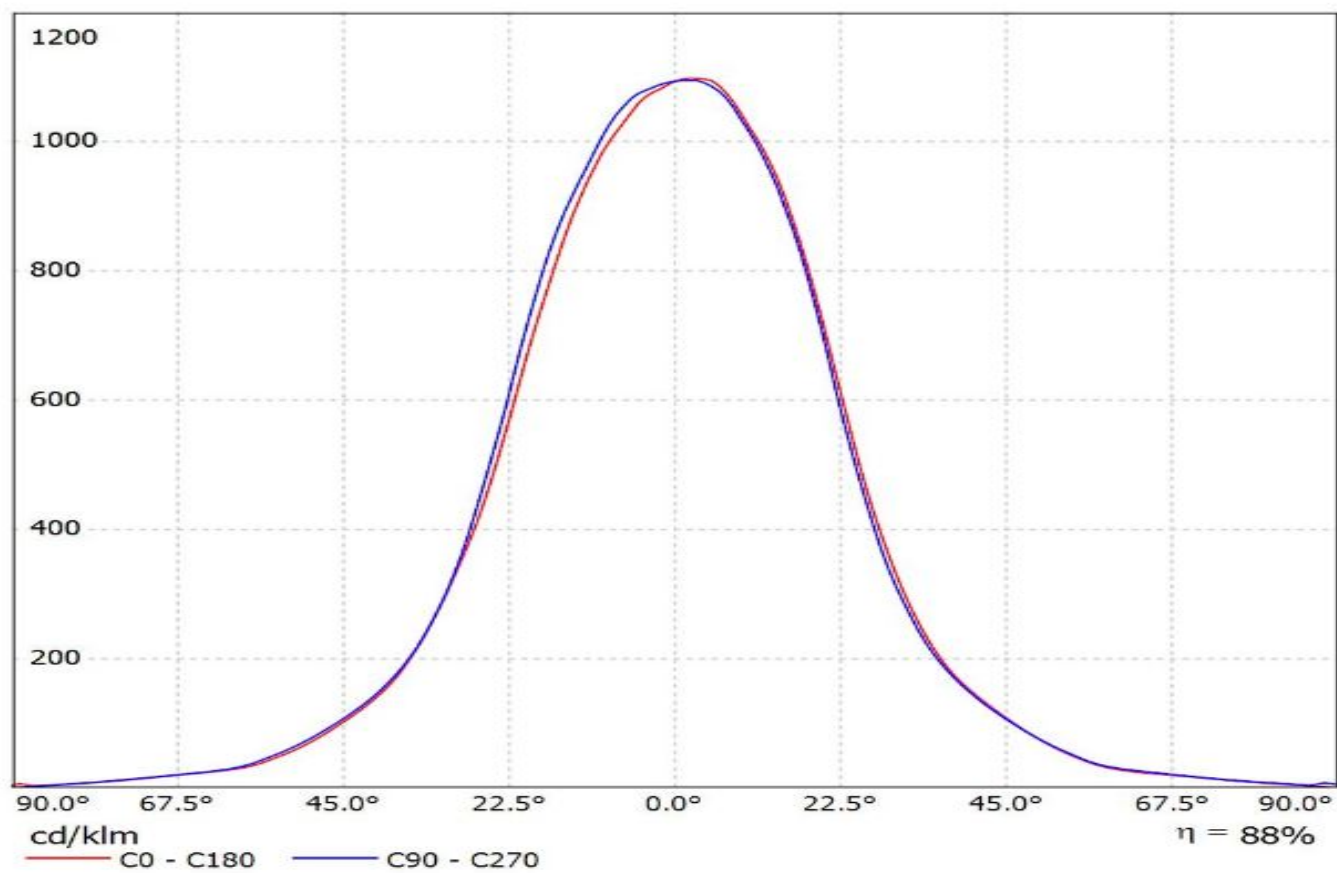

Luminaire: LEDiL Oy CN14238_WINNIE-W_(COB_D_LES-14,5mm)

Lamps: 1 x Samsung_COB_D_Series-LES-14,5_LC026D_1272.15lm@250mA_P=8.07678W_I=0.250A

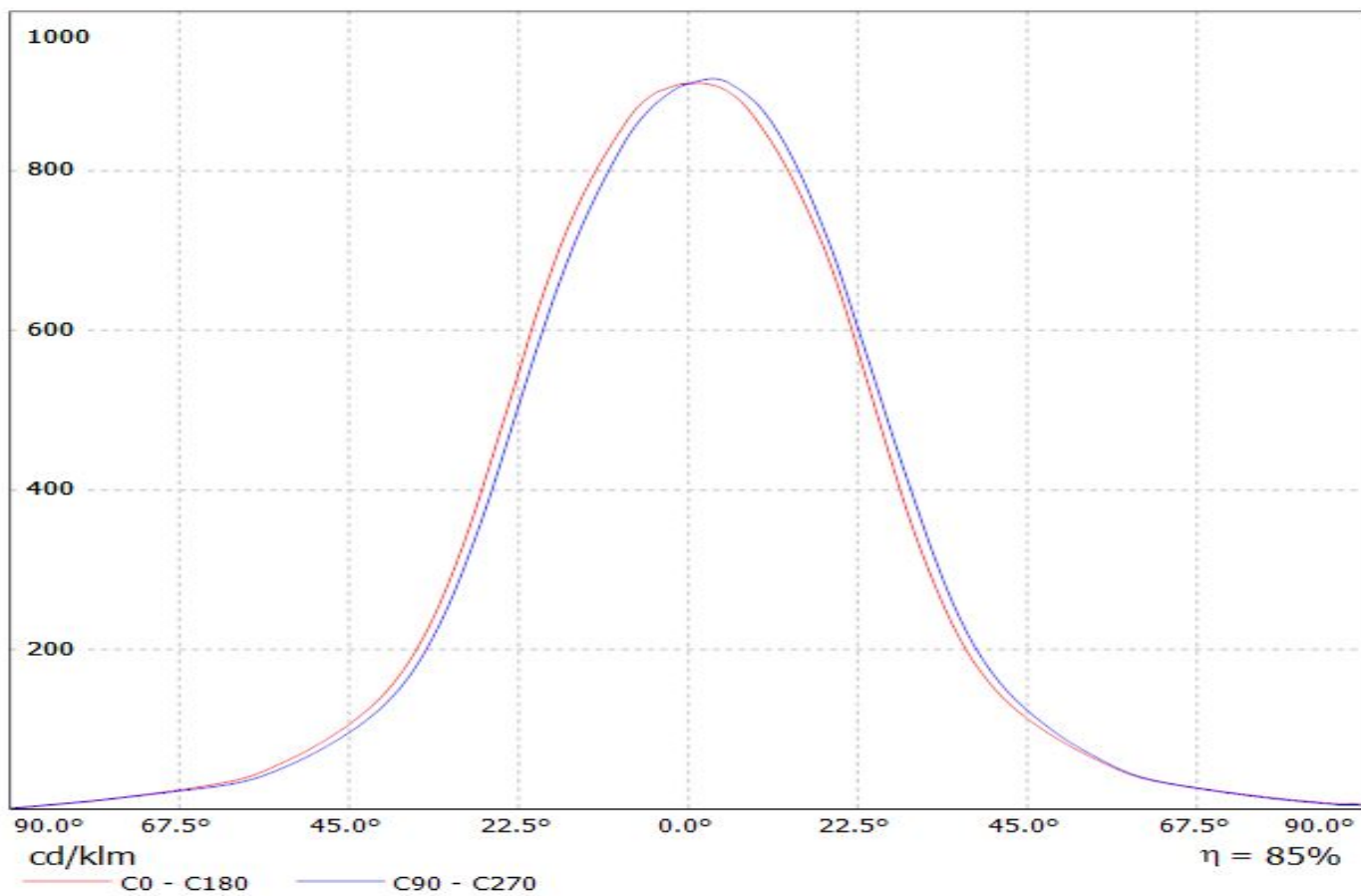

Luminaire: LEDiL Oy CN14238_WINNIE-W_(ZC12)

Lamps: 1 x Seoul_ZC12_(SDW82F1C)_+_B+W_433_Typ_L5_1217.21lm@250mA_P=8.64733W_I=250mA

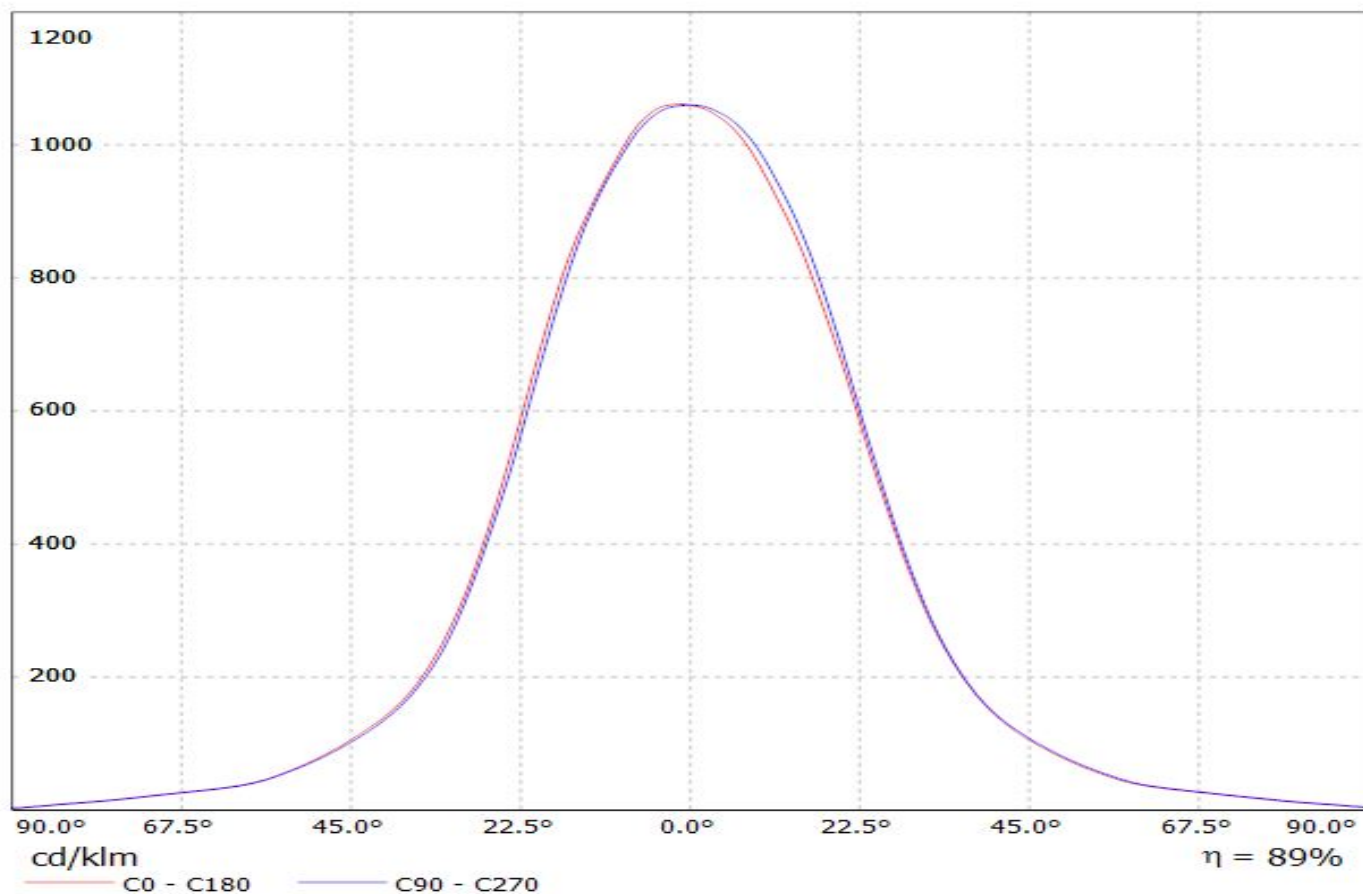

Luminaire: Ledil CN14238_WINNIE-W_(MJT_12W_Les9,8)

Lamps: 1 x Seoul_MJT_12W_Les9.8mm_(SAWx1063A)_1271.35lm@250mA_P=8.45475W_I=0.25A

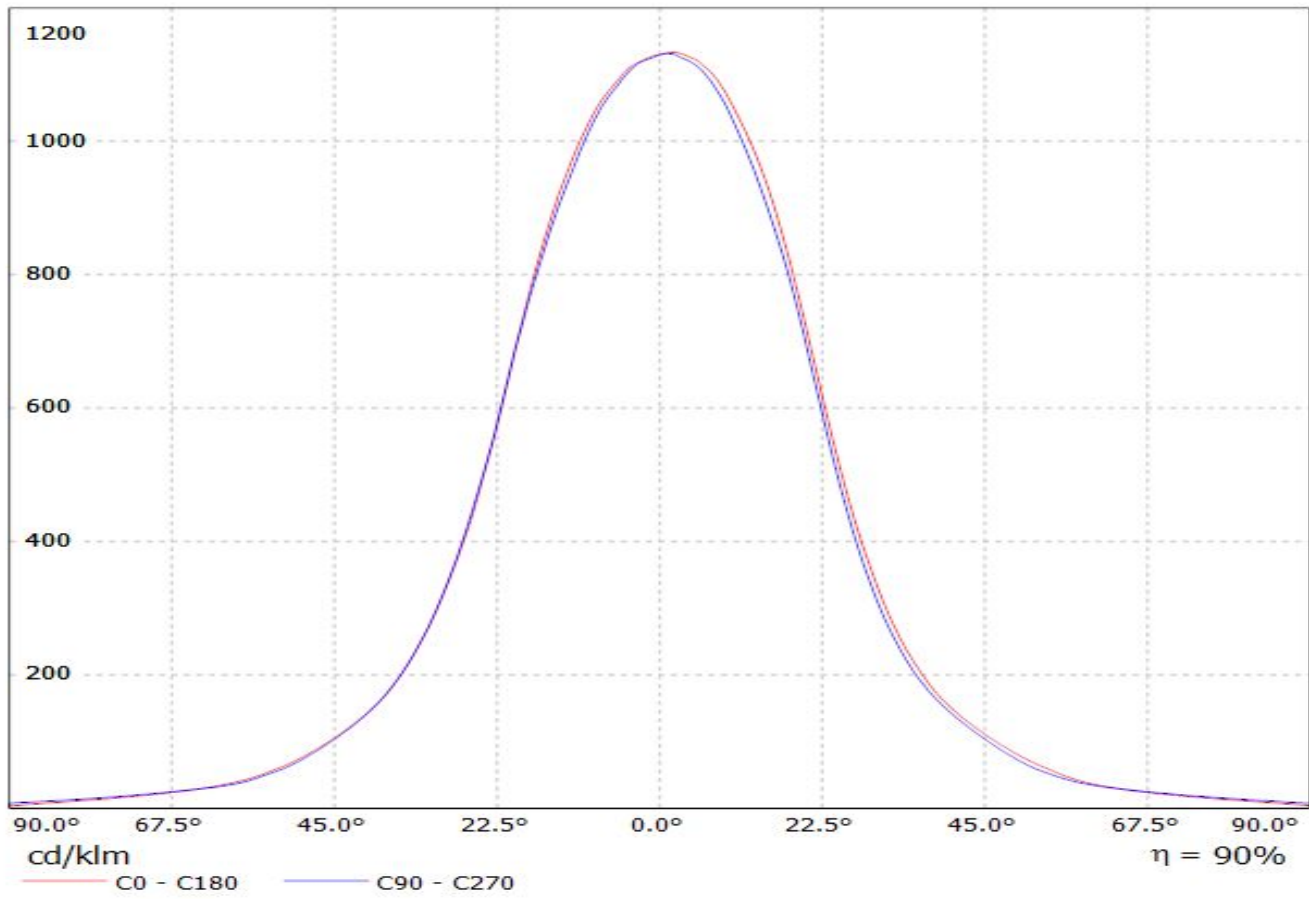

Luminaire: Ledil CN14238_WINNIE-W_(MJT_30W_Les14,5)_+433_Typ_L5

Lamps: 1 x Seoul_MJT_30W_Les14,5mm_(SAWx1566A)_+433_Typ_L5_1352.83lm@250mA_P=8.2325W_I=0.25A

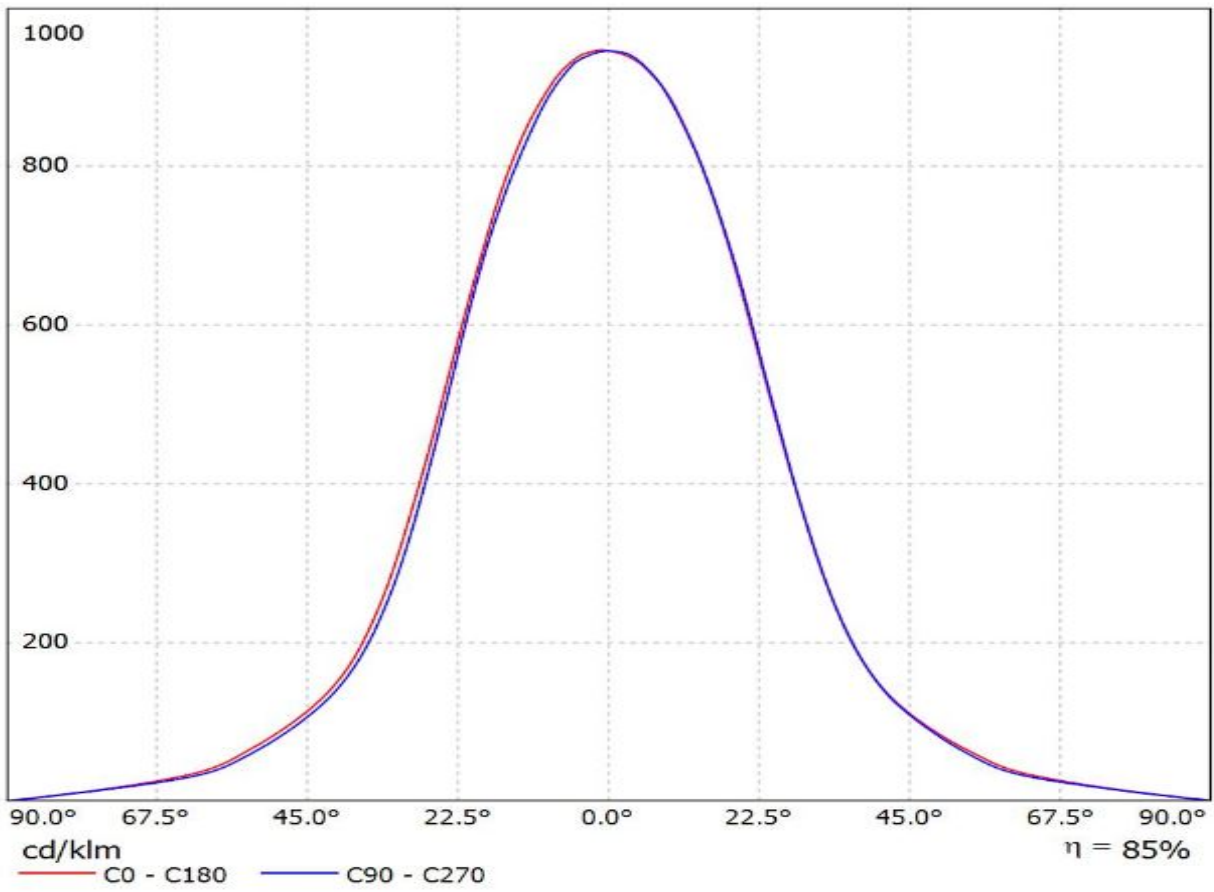

Luminaire: LEDiL Oy CN14238_WINNIE-W_(SLE-G5_LES-6)
Lamps: 1 x Tridonic_SLE-G5_LES-6_472.41lm@100mA_P=3.3763W_I=0.100A

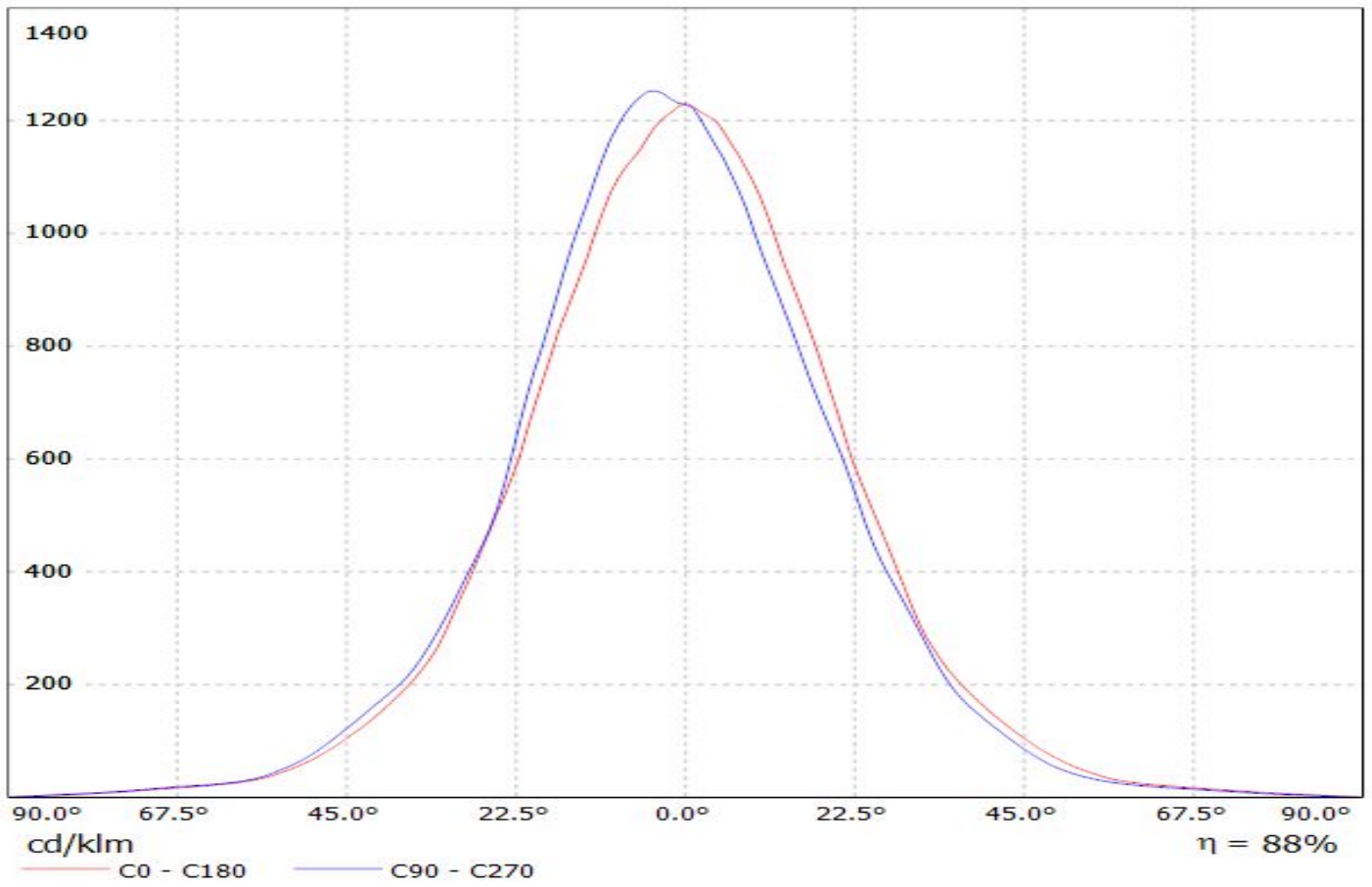

Luminaire: LEDiL Oy CN14238_WINNIE-W_(SLE-G5_LES-11)

Lamps: 1 x Tridonic_SLE-G5_LES-15_1138.42lm@250mA_P=8.4110W_I=0.250A

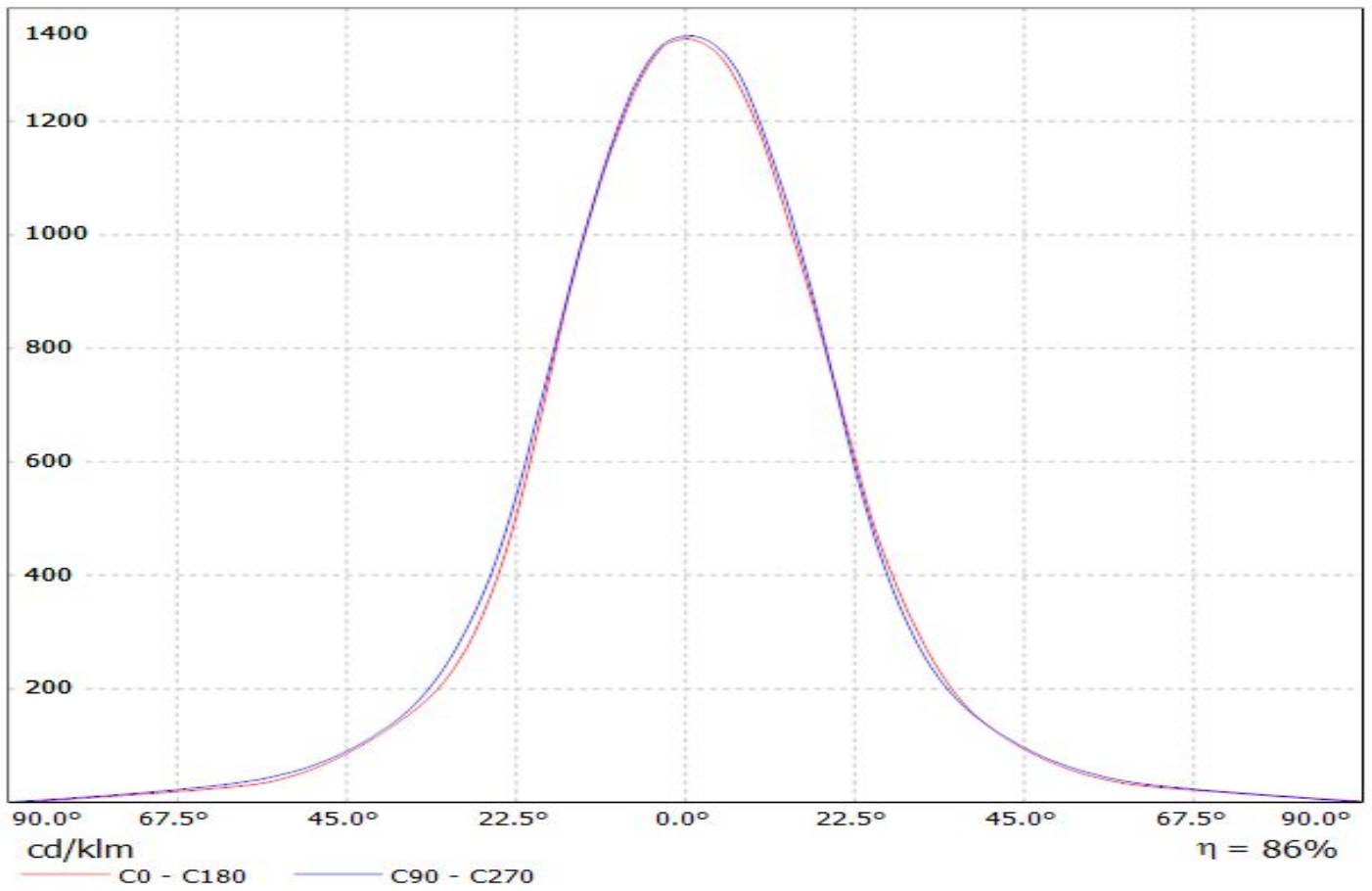

Luminaire: LEDiL Oy CN14238_WINNIE-W_(SLE-G5_LES-15)

Lamps: 1 x Tridonic_SLE-G5_LES-15_1267.45lm@250mA_P=8.6695W_I=0.250A

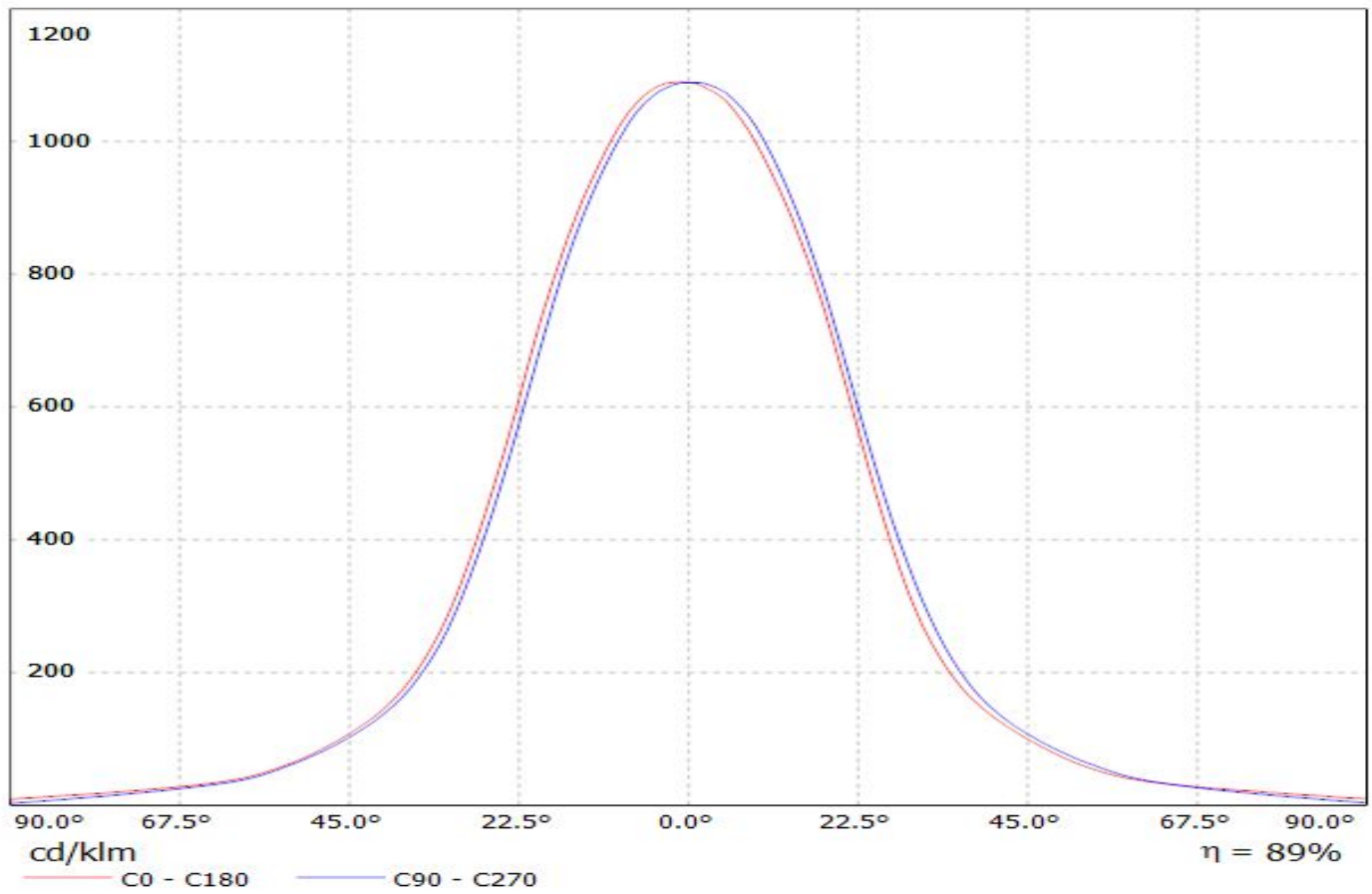

Luminaire: Ledil Oy CN14238_WINNIE-W_(SLE_G6_LES15)_ (433_Typ_L5)_SIMULATED
Lamps: 1 x Tridonic SLE G5 LES15 + Bender & Wirth 433 Typ L5

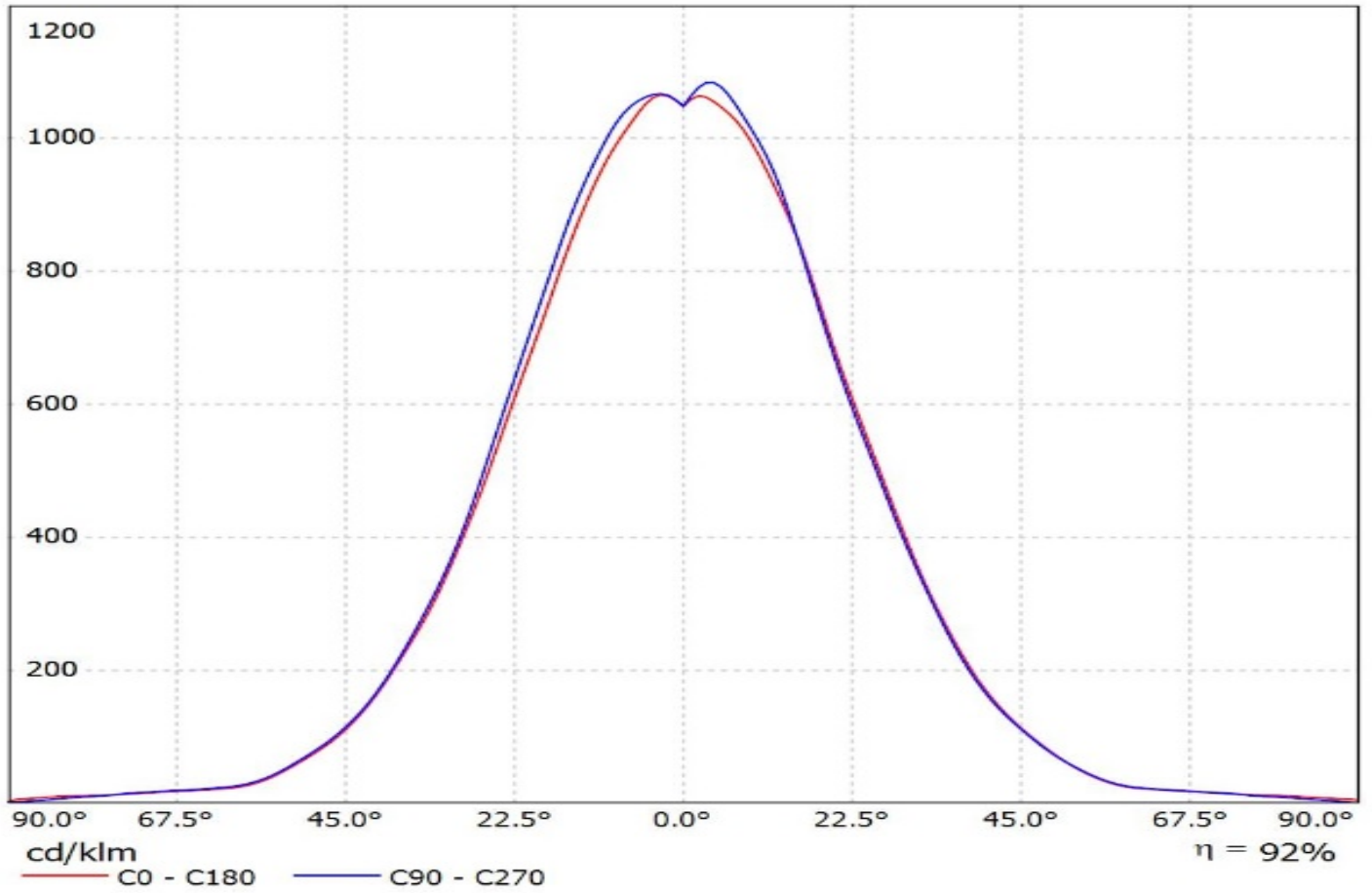

Luminaire: Ledil Oy CN14238_WINNIE-W+_B+W_433_Typ_L5_TRIDONIC_SLE_G6_LES17_SIMULATED
Lamps: 1 x TRIDONIC SLE G6 LES17

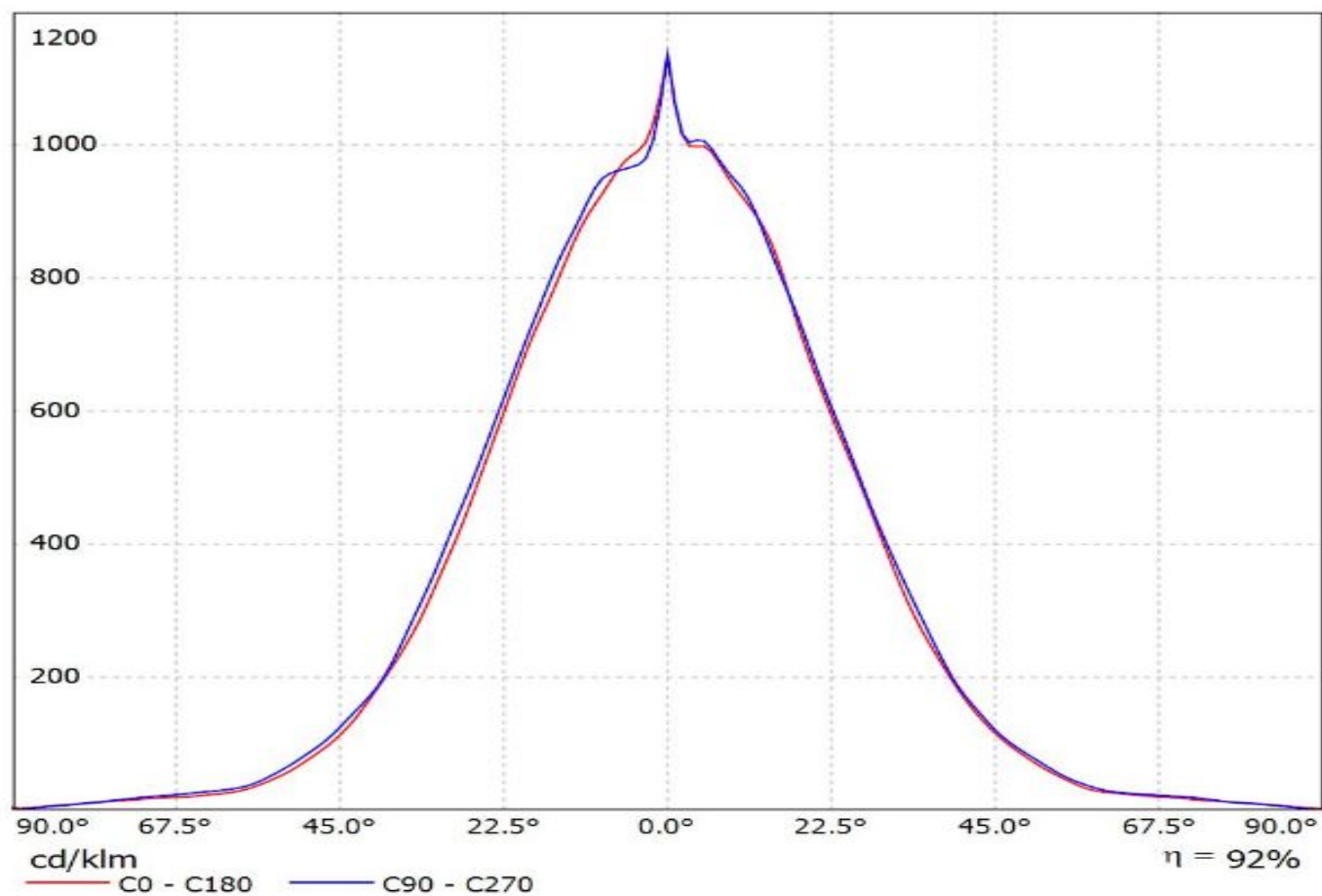

Luminaire: LEDiL Oy CN14238_WINNIE-W_(DMC125)

Lamps: 1 x DMC125+433_Typ_L5_1101.77lm@250mA_P=8.53017W_I=250mA

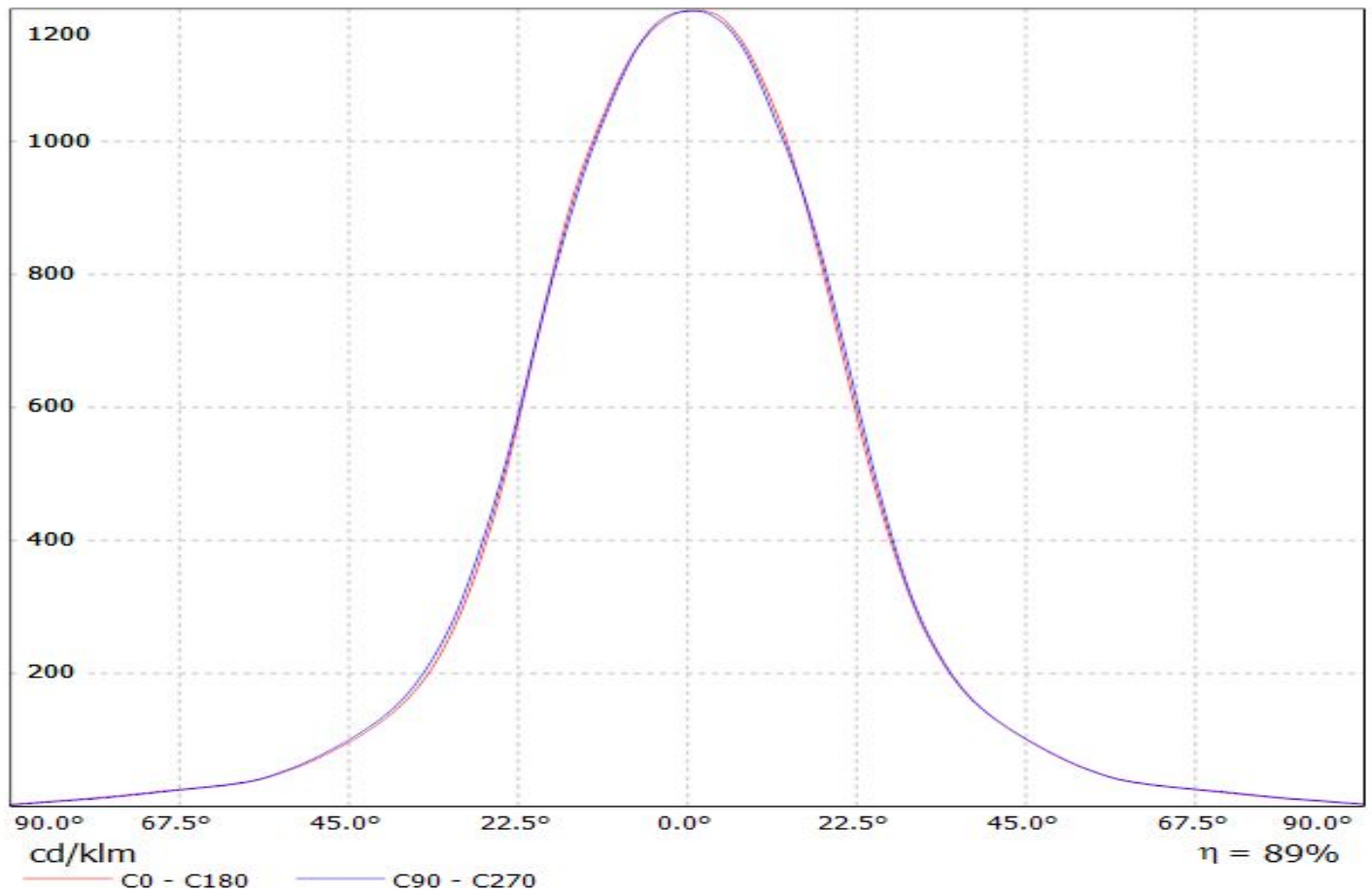

Luminaire: LEDiL Oy CN14238_WINNIE-W (DMC128)

Lamps: 1 x DMC128+433_TYP_L5_825.549lm@250mA_P=8.28162W_I=250mA

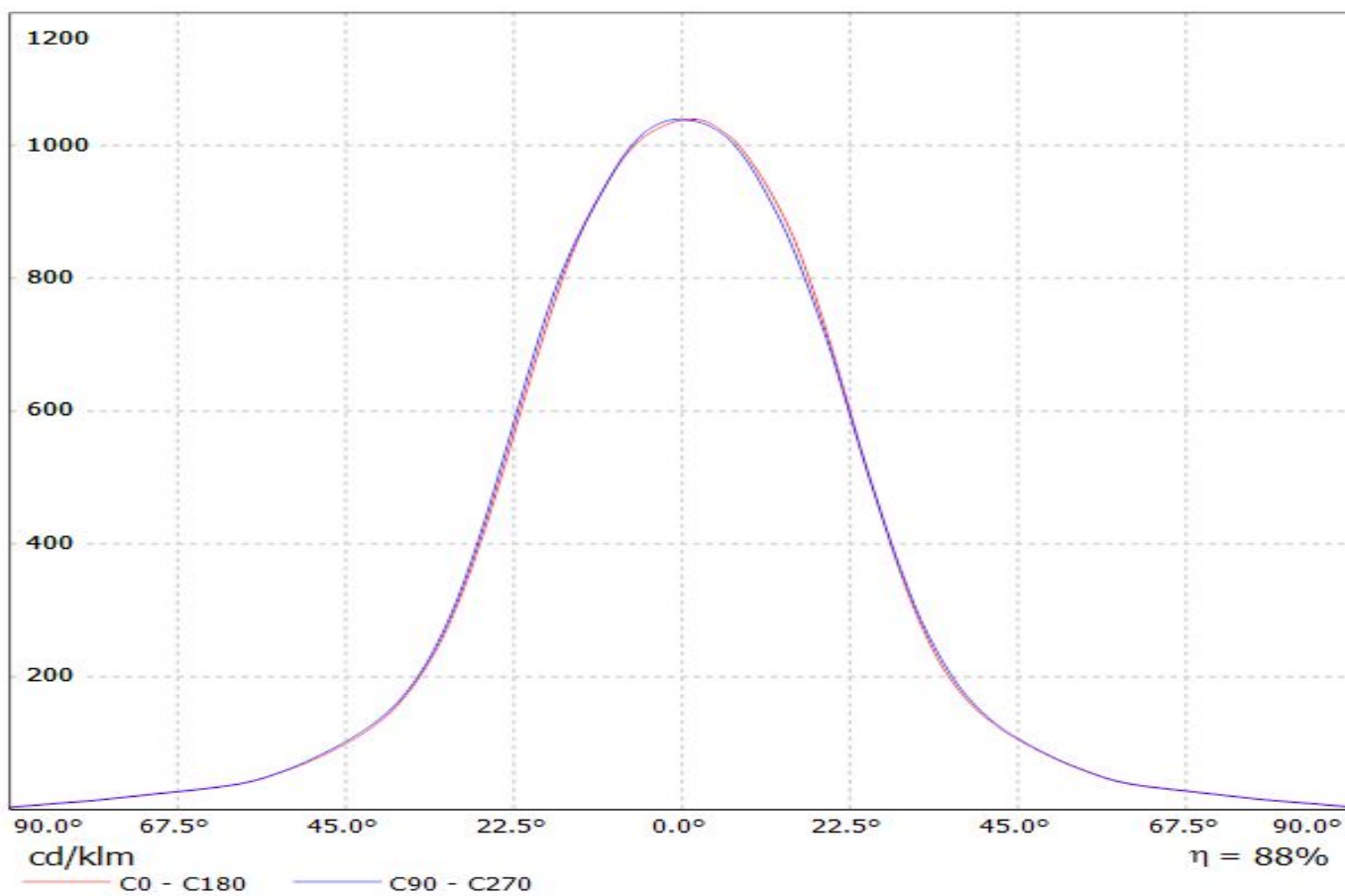

Luminaire: LEDiL Oy CN14238_WINNIE-W_(VERO10)

Lamps: 1 x Bridgelux_VERO10_(301000B)_758.633lm@250mA_P=6.35346W_I=0.2499A

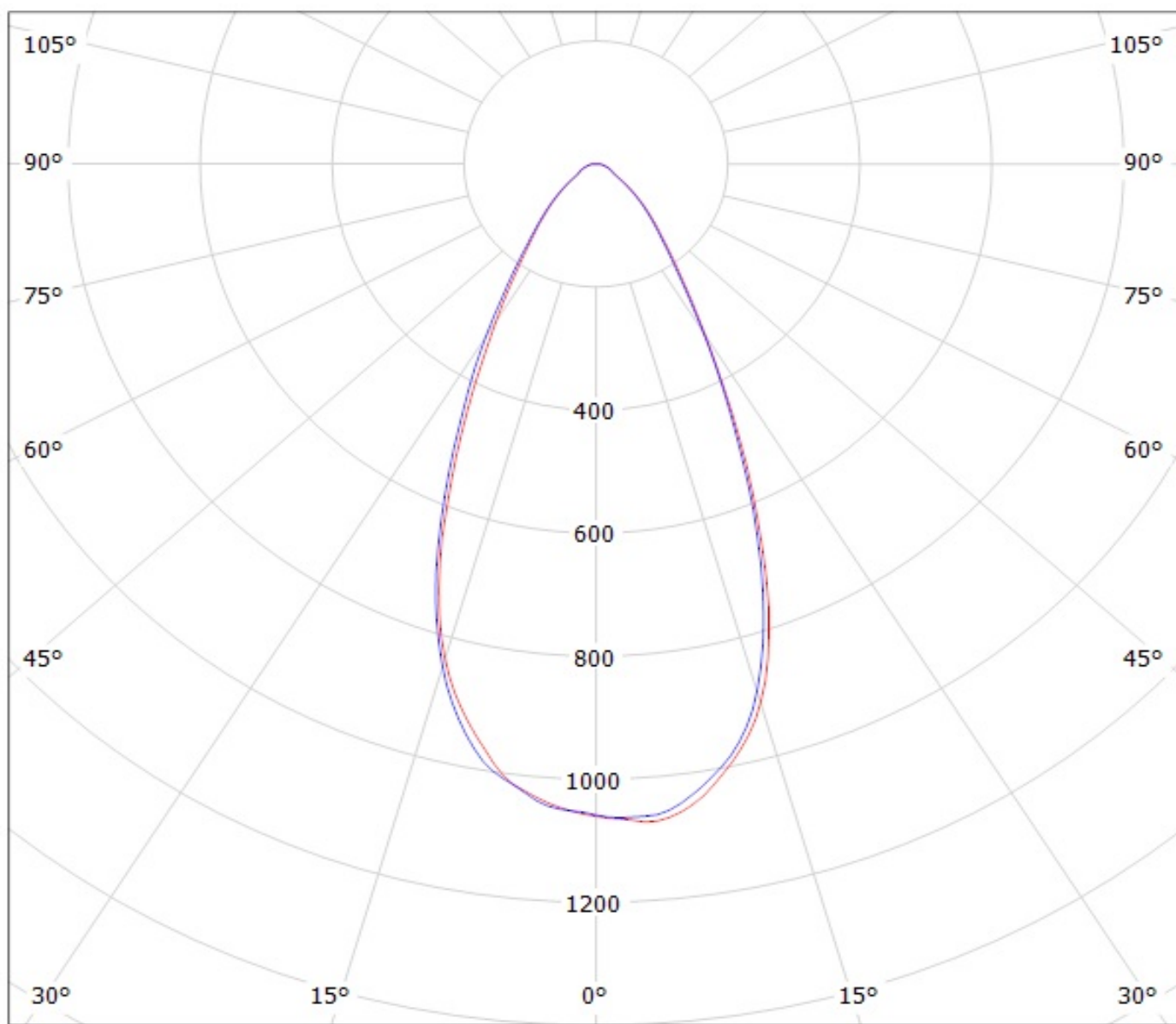

cd/klm

— C0 - C180

— C90 - C270

$\eta = 90\%$

Luminaire: Ledil CN14238_WINNIE-W_(V18)

Lamps: 1 x Bridgelux_V18_(BXRC-30E4000-F-23)_1084.28lm@250mA_P=6.8355W_I=0.250A

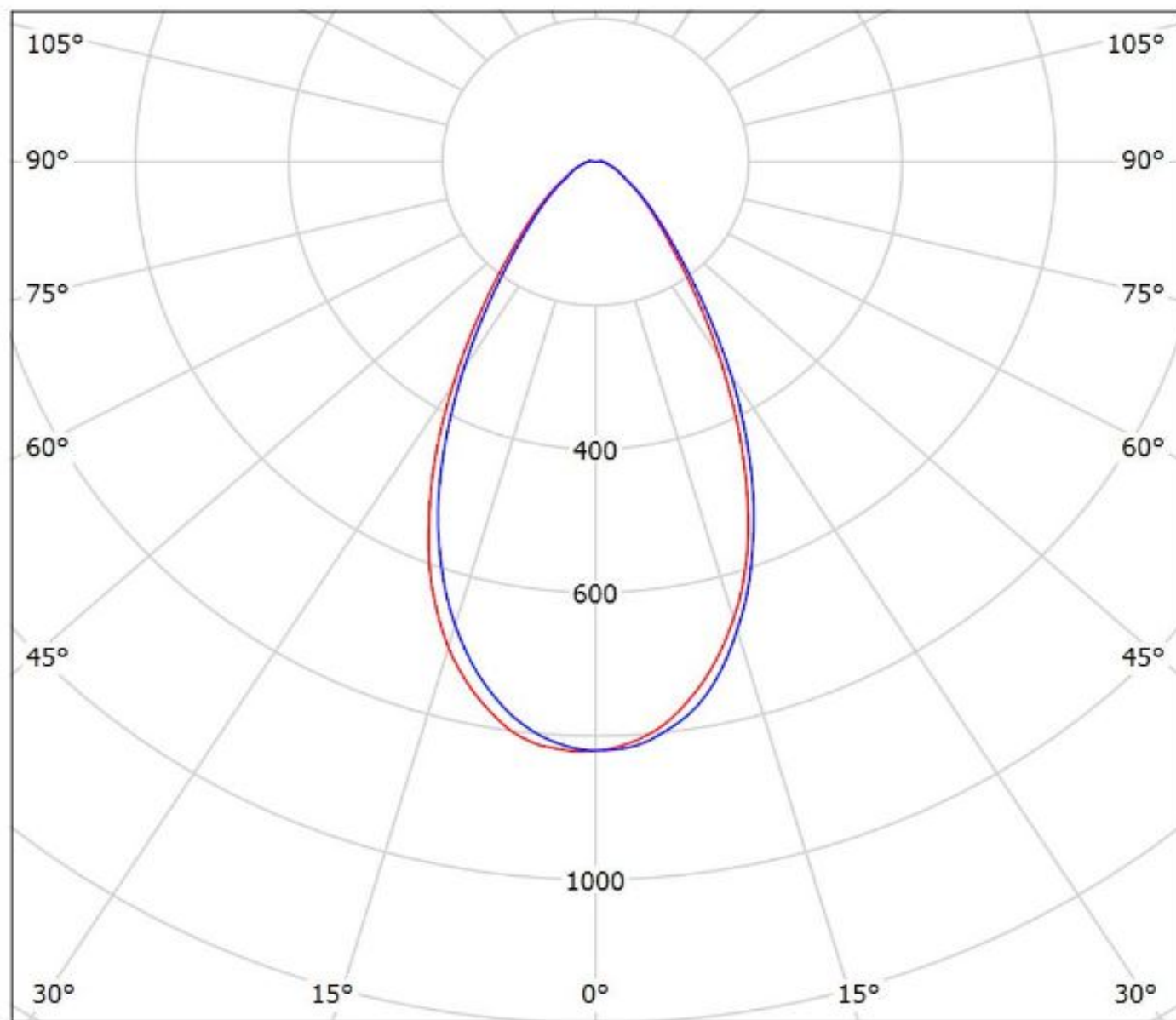

cd/klm

— C0 - C180 — C90 - C270

$\eta = 88\%$

Luminaire: LEDiL Oy CN14238_WINNIE-W (CLU034)

Lamps: 1 x Citizen_CLU034_(CLL034-1205B8-303M1A2)_+_B+W_433_Typ_L5_1154.06lm@250mA_P=8.45523W_I=250mA

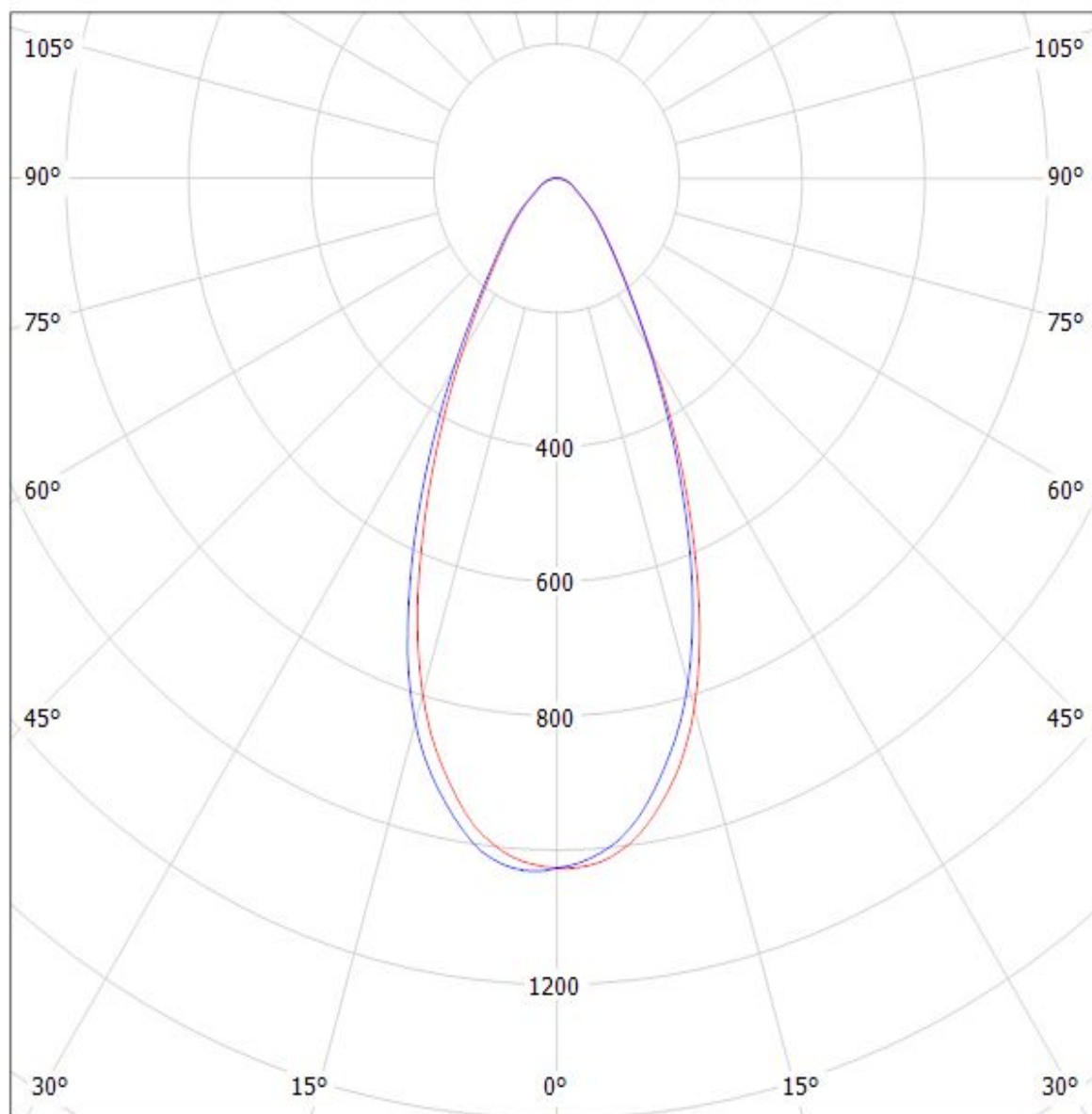

cd/klm

$\eta = 88\%$

— C0 - C180

— C90 - C270

Ledil CN14238_WINNIE-W_(CLU710) / LDC (Polar)

Luminaire: Ledil CN14238_WINNIE-W_(CLU710)

Lamps: 1 x CITIZEN_CLU710_(CLU710-1204B8-273M2G1)_1210.56lm@250mA_P=8.5W_I=0.25A

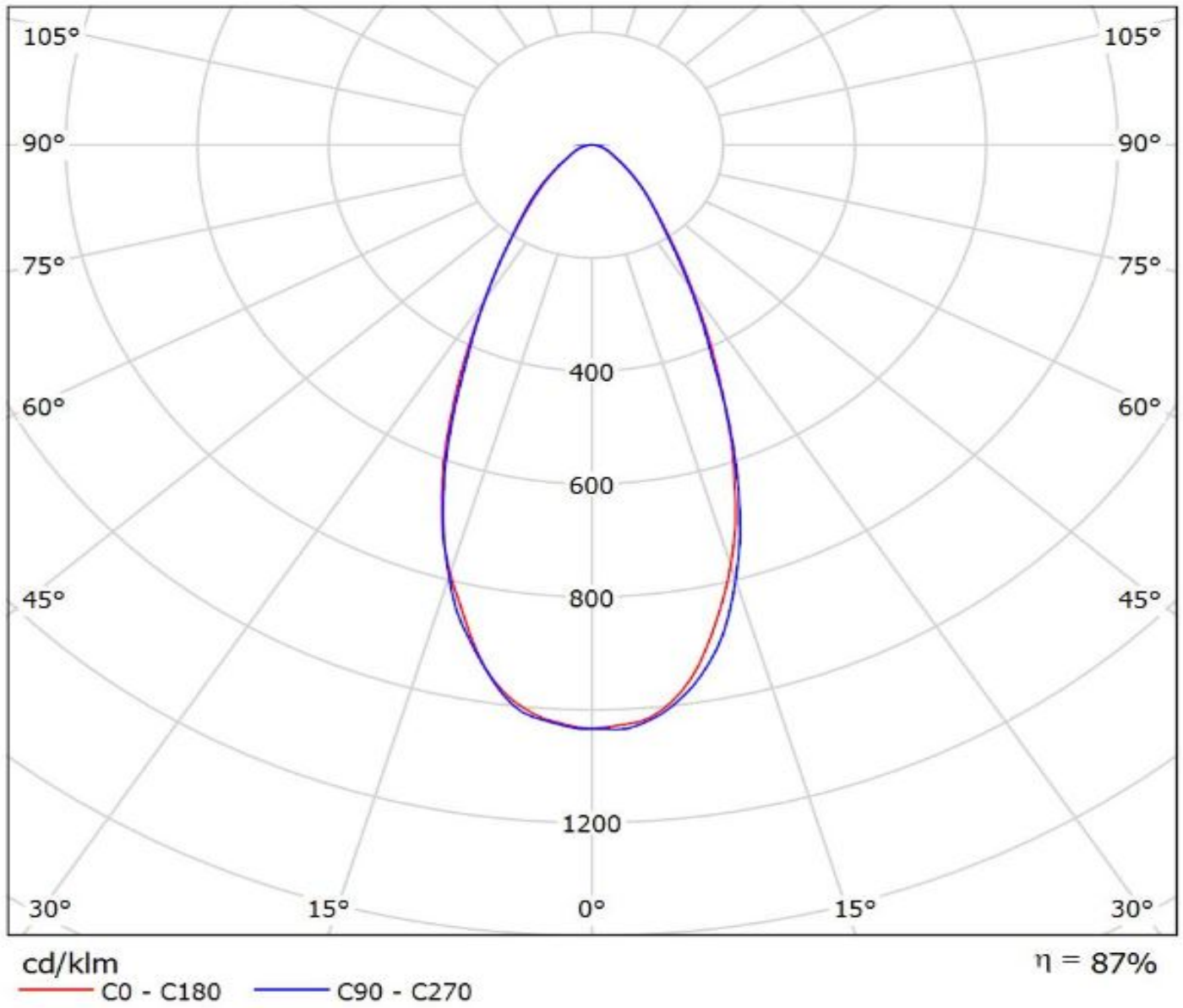

Luminaire: LEDiL Oy CN14238_WINNIE-W_(CLU024)_434-Typ-L5

Lamps: 1 x Citizen_CLU-024_(CLU024-1204B8-303M1A2)_434-Typ-L5_1023.5lm@250mA_P=8.57963W_I=0.2498A

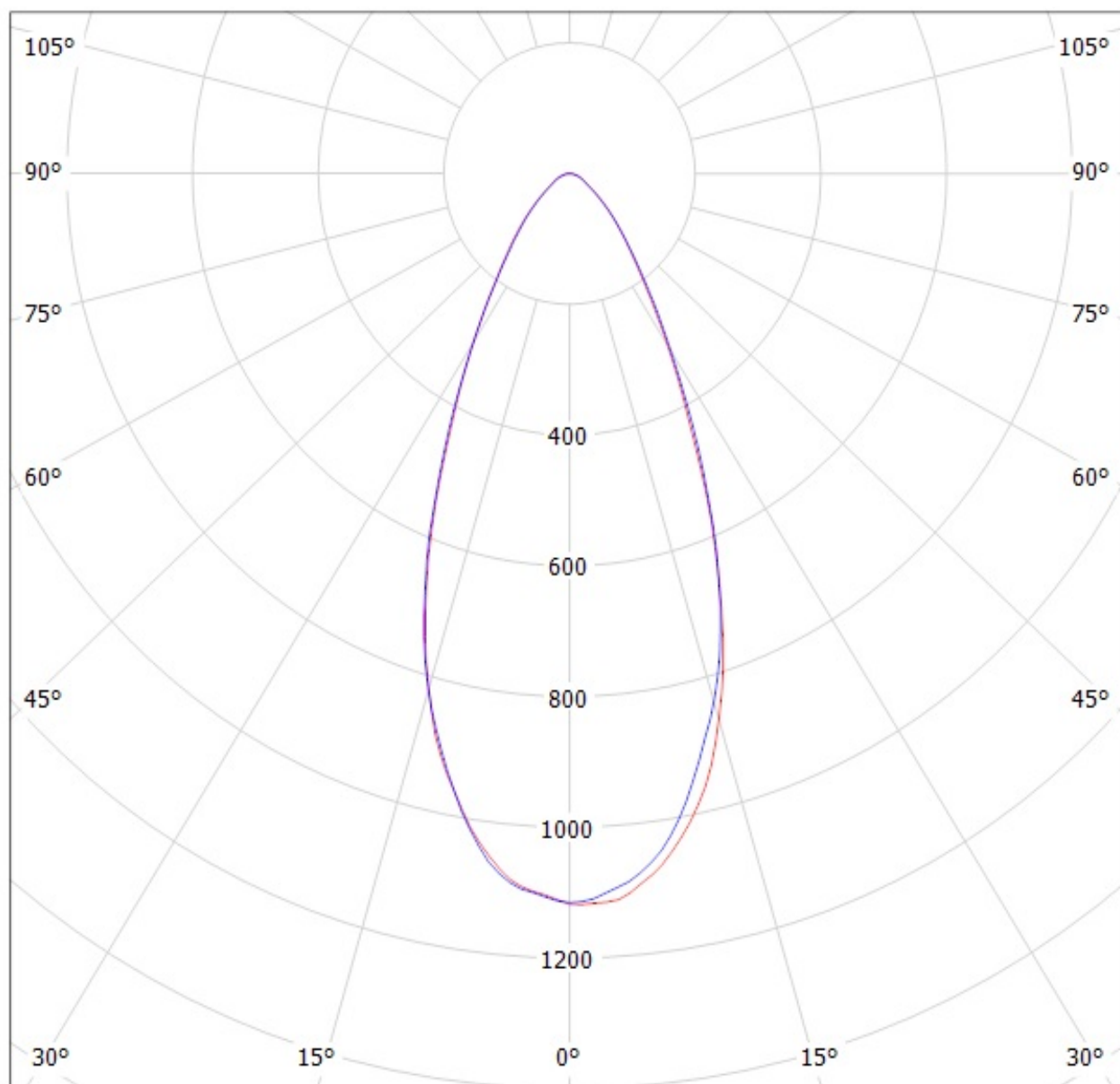

cd/klm

$\eta = 87\%$

— C0 - C180 — C90 - C270

Luminaire: LEDiL Oy CN14238_WINNIE-W_(CLU700)_434-Typ-L5

Lamps: 1 x Citizen_CLU700_(CLU700-1002B8-273M2G1)_434_Typ_L5_377.008lm@100mA_P=2.82212W_I=0.1001A

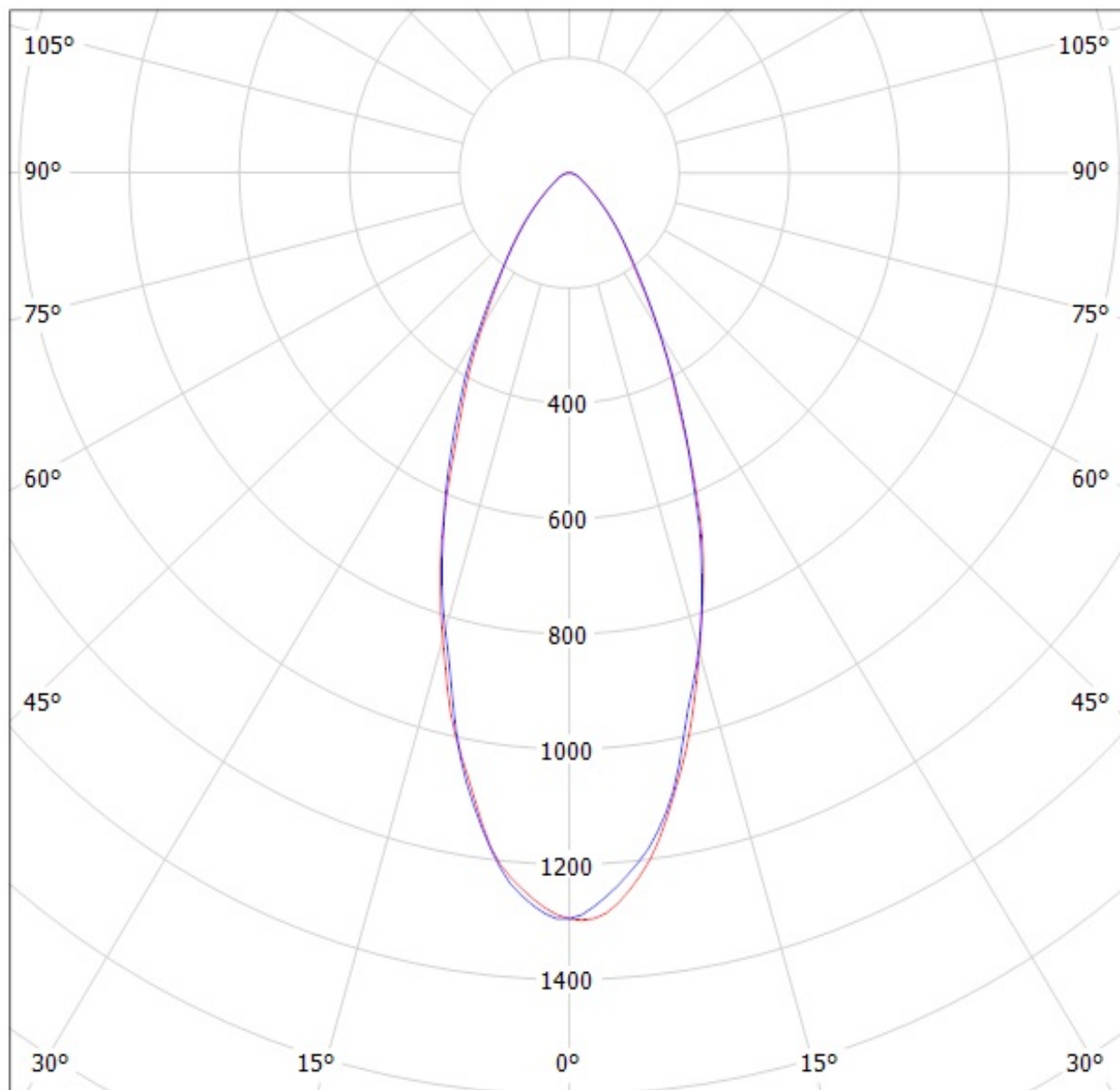

cd/klm

— C0 - C180

— C90 - C270

$\eta = 88\%$

Ledil CN14238_WINNIE-W_(CLU720) / LDC (Polar)

Luminaire: Ledil CN14238_WINNIE-W_(CLU720)

Lamps: 1 x Citizen_CLU720_(CLU720-1206B8-273M2G1)_1253.68lm@250mA_P=8.3W_I=0.25A

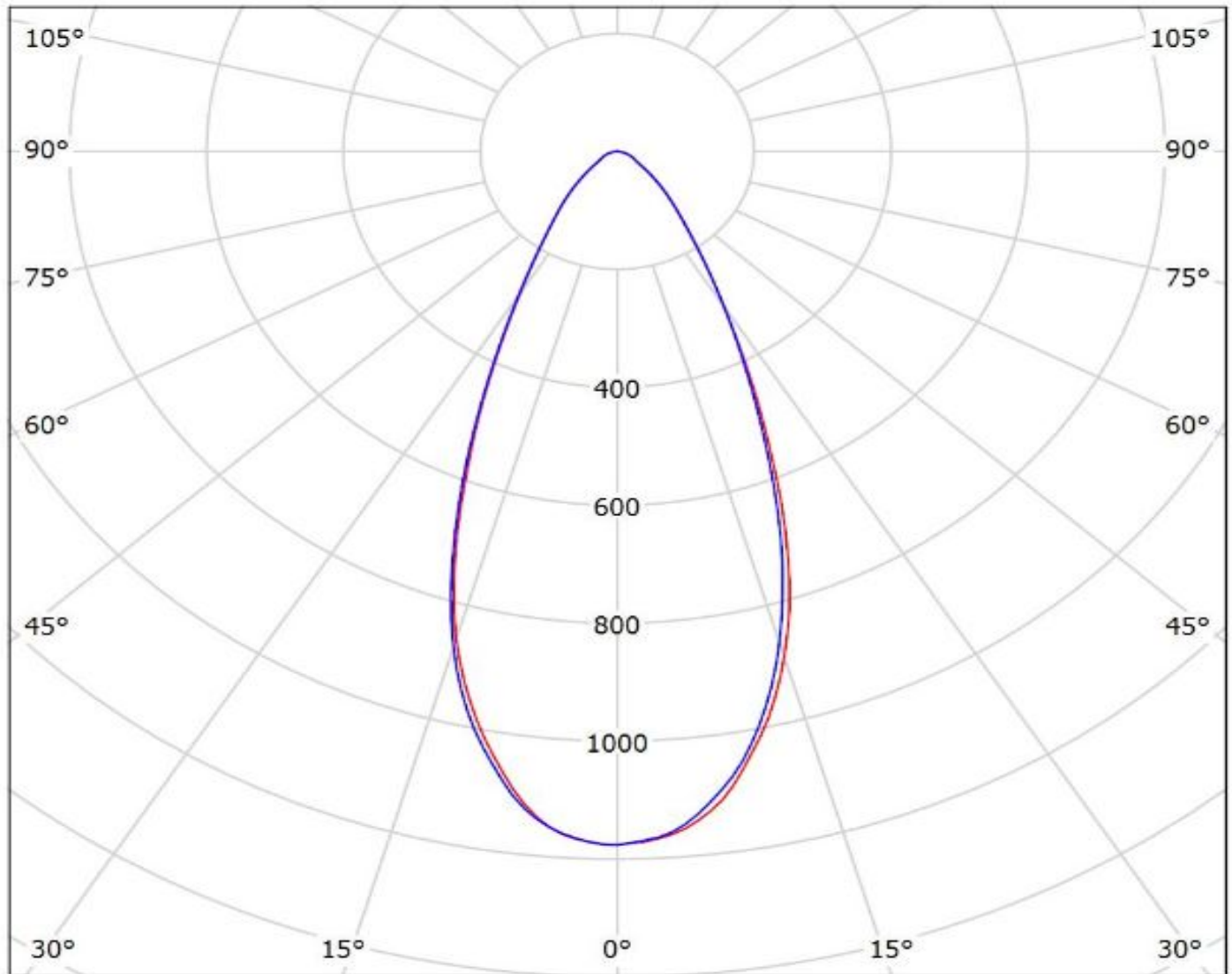

cd/klm

— C0 - C180 — C90 - C270

$\eta = 87\%$

Luminaire: LEDiL Oy CN14238_WINNIE-W_(CLU700)

Lamps: 1 x Citizen_CLU700_367.467lm@100mA_P=2.77574W_I=0.1002A

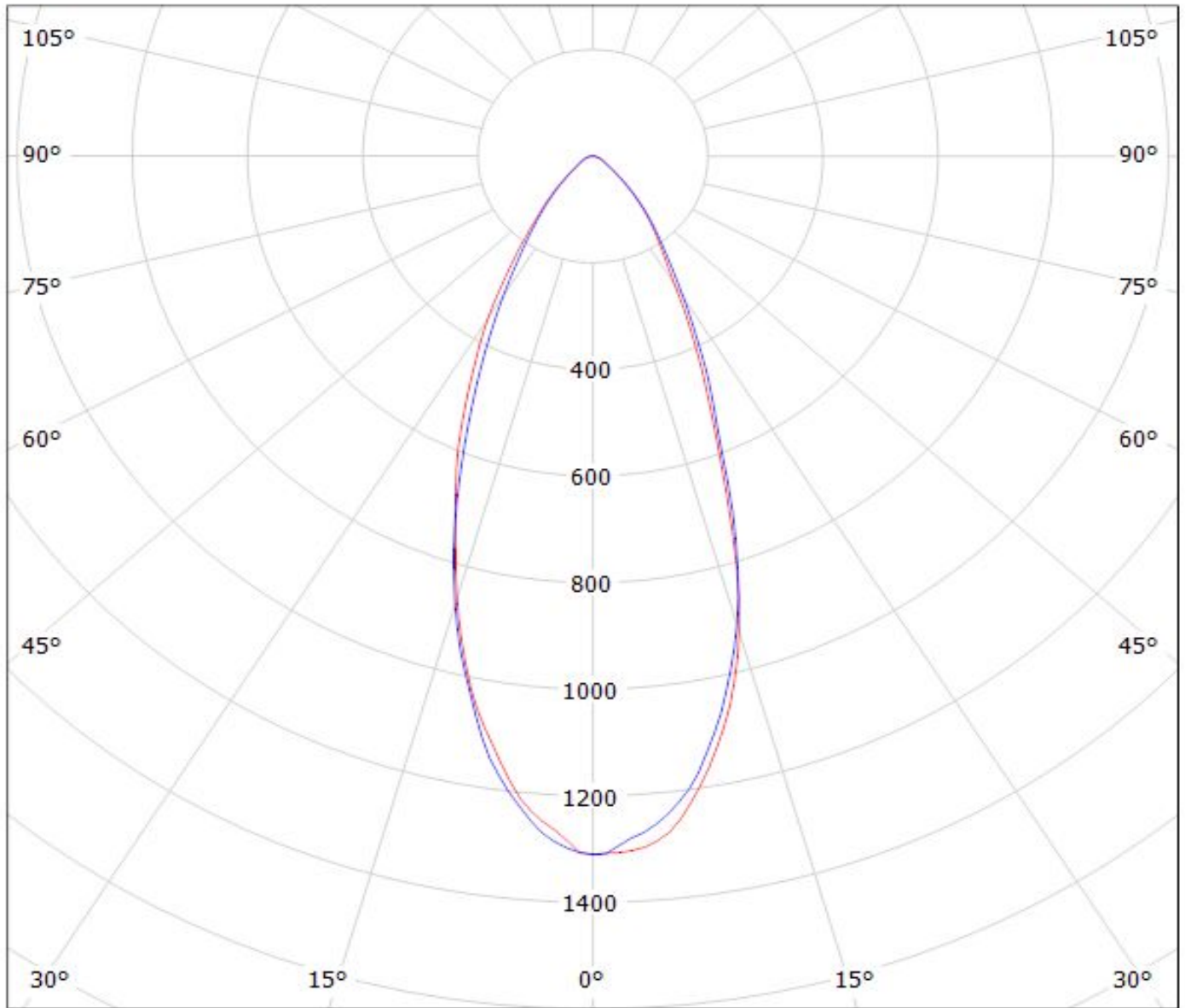

cd/klm

— C0 - C180

— C90 - C270

$\eta = 88\%$

Ledil CN14238_WINNIE-W_(CLU710)_(470_Typ_L5) / LDC (Polar)

Luminaire: Ledil CN14238_WINNIE-W_(CLU710)_(470_Typ_L5)
Lamps: 1 x Citizen_CLU710_(CLU710-1204B8-273M2G1)_(470_Typ_L5)
_1134.69lm@250mA_CCT=2700K_P=8.5W_I=0.25A

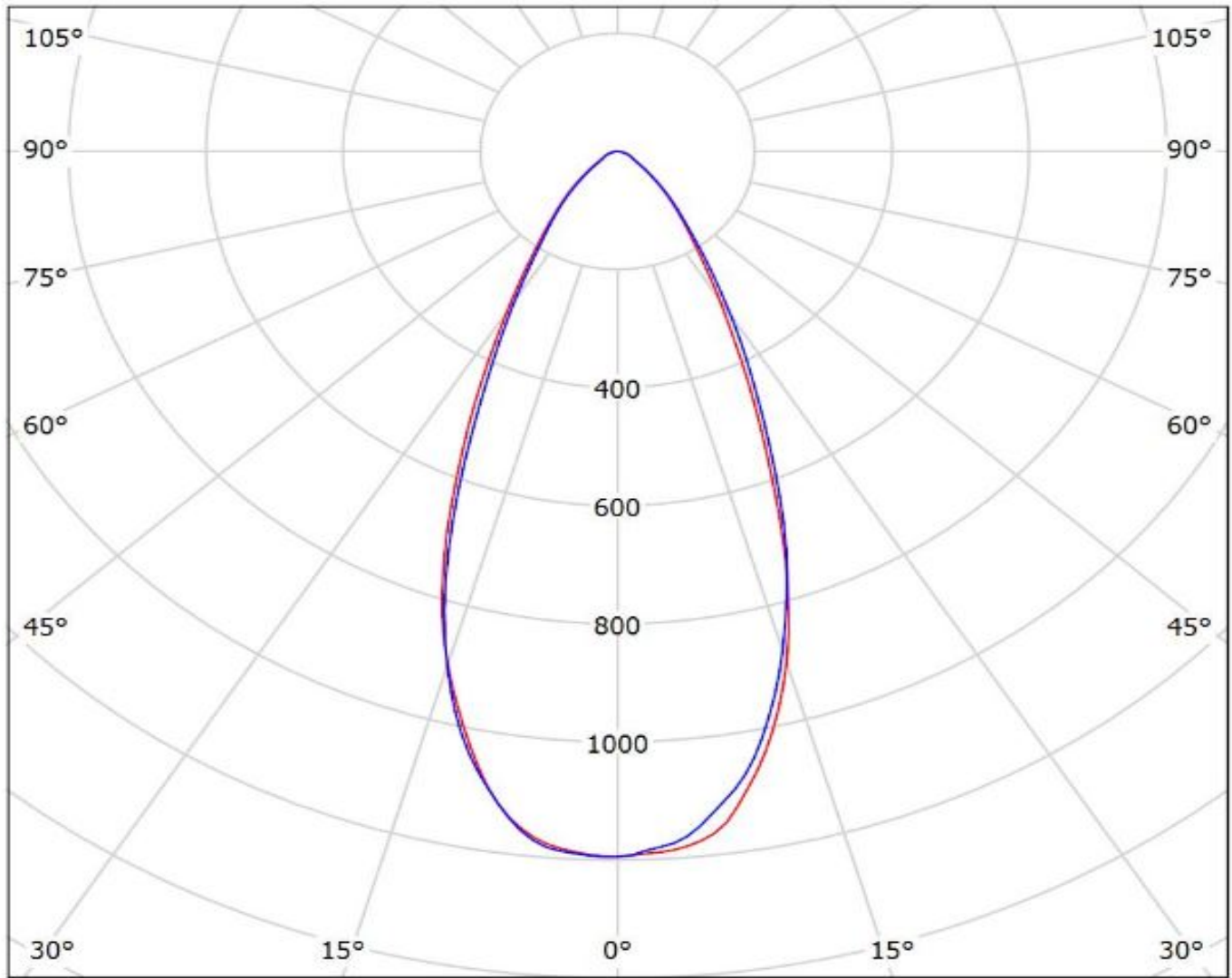

Luminaire: Ledil CN14238_WINNIE-W_(MHD-G)

Lamps: 1 x Cree MHD-G_530.44lm@100mA_P=3.0W_I=0.100A

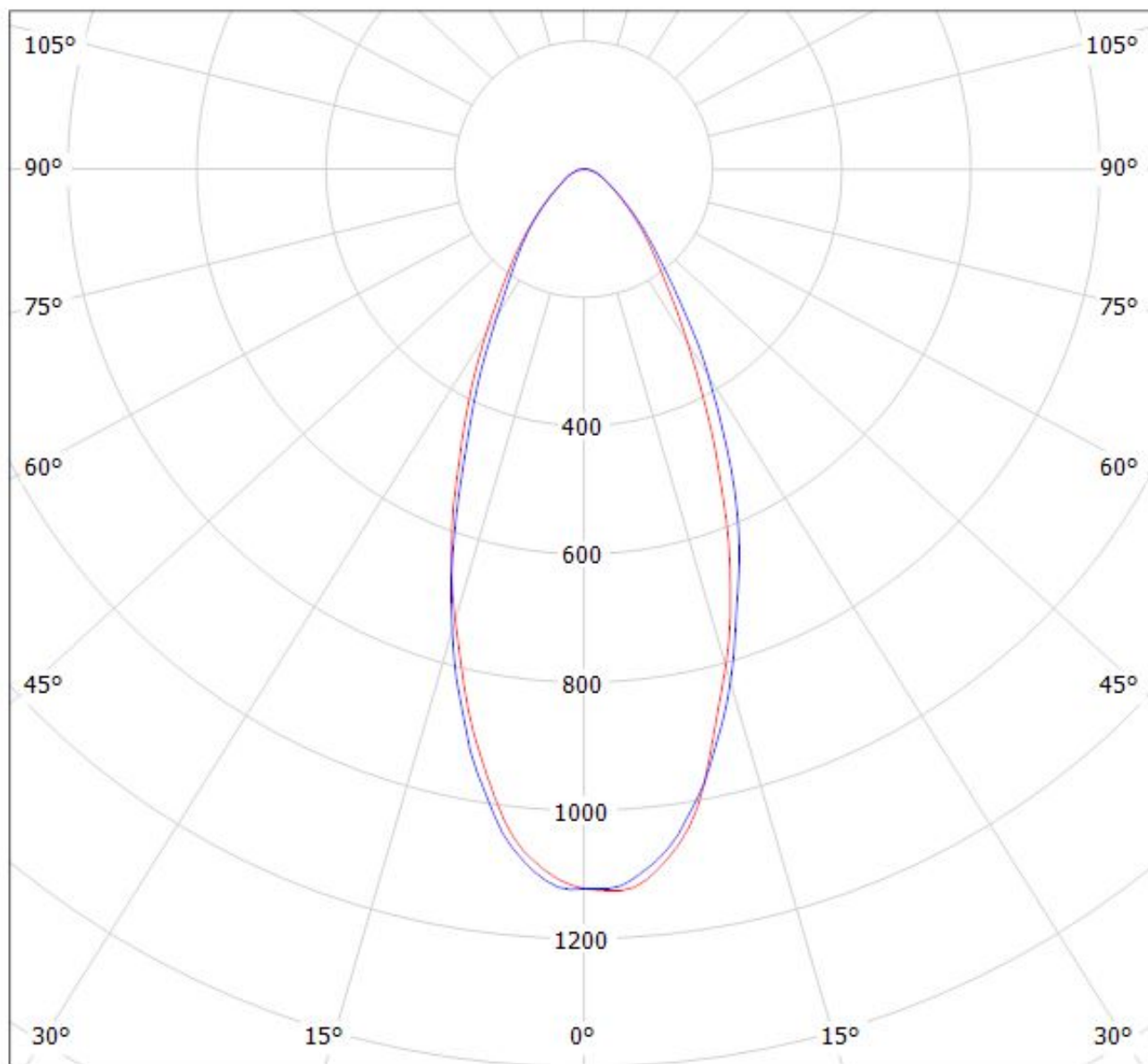

cd/klm

— C0 - C180

— C90 - C270

$\eta = 88\%$

Luminaire: Ledil Oy CN14238_WINNIE-W_(Soleriq_S9)_SIMULATED
Lamps: 1 x Osram Soleriq S9 (GW KAFJB3.EM)

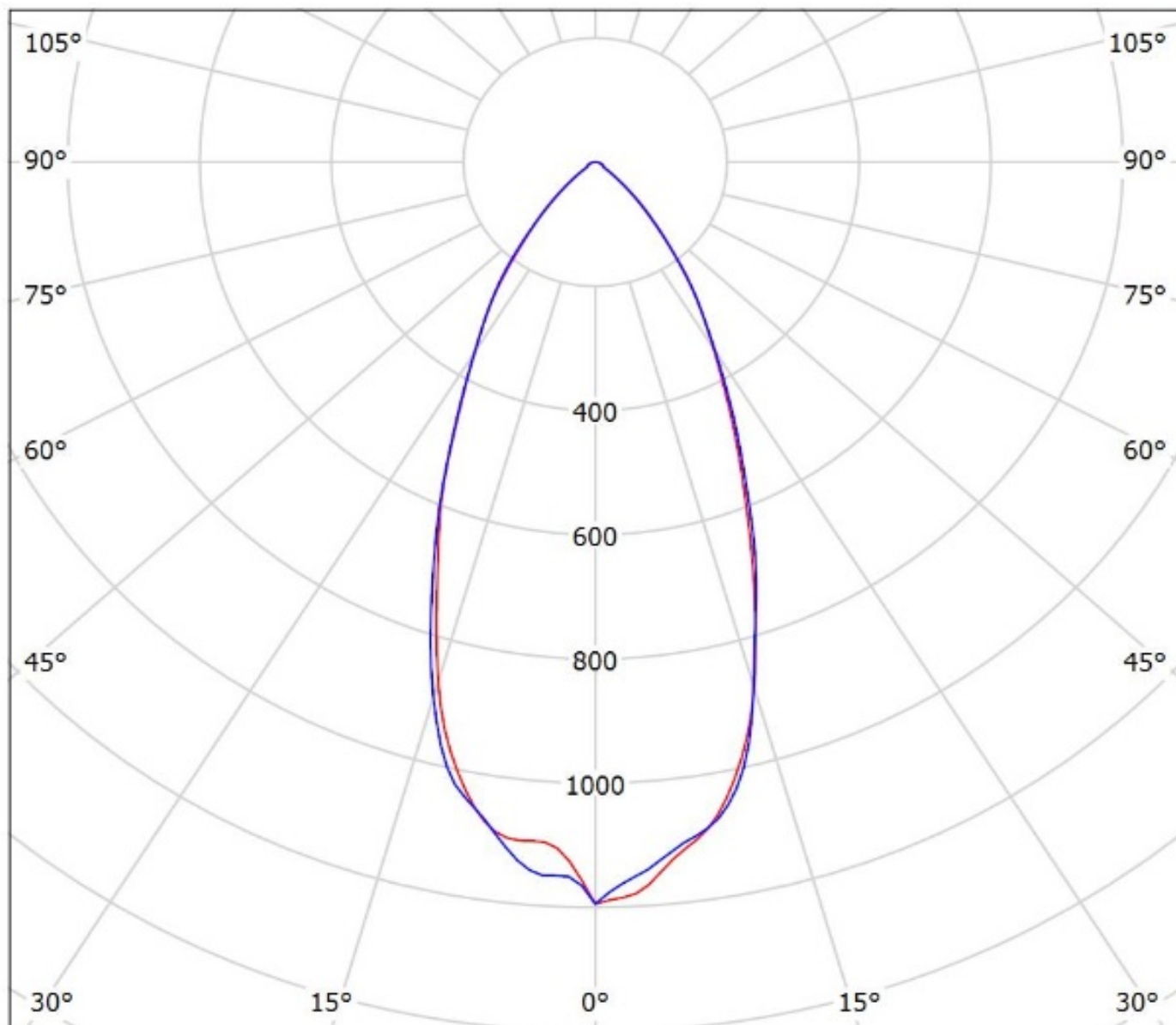

cd/klm

— C0 - C180 — C90 - C270

$\eta = 90\%$

Luminaire: Ledil Oy CN14238_WINNIE-W_(LC010C)_(479_type_L5)_SIMULATED
Lamps: 1 x Samsung LC101C + Bender & Wirth 479 Type L5

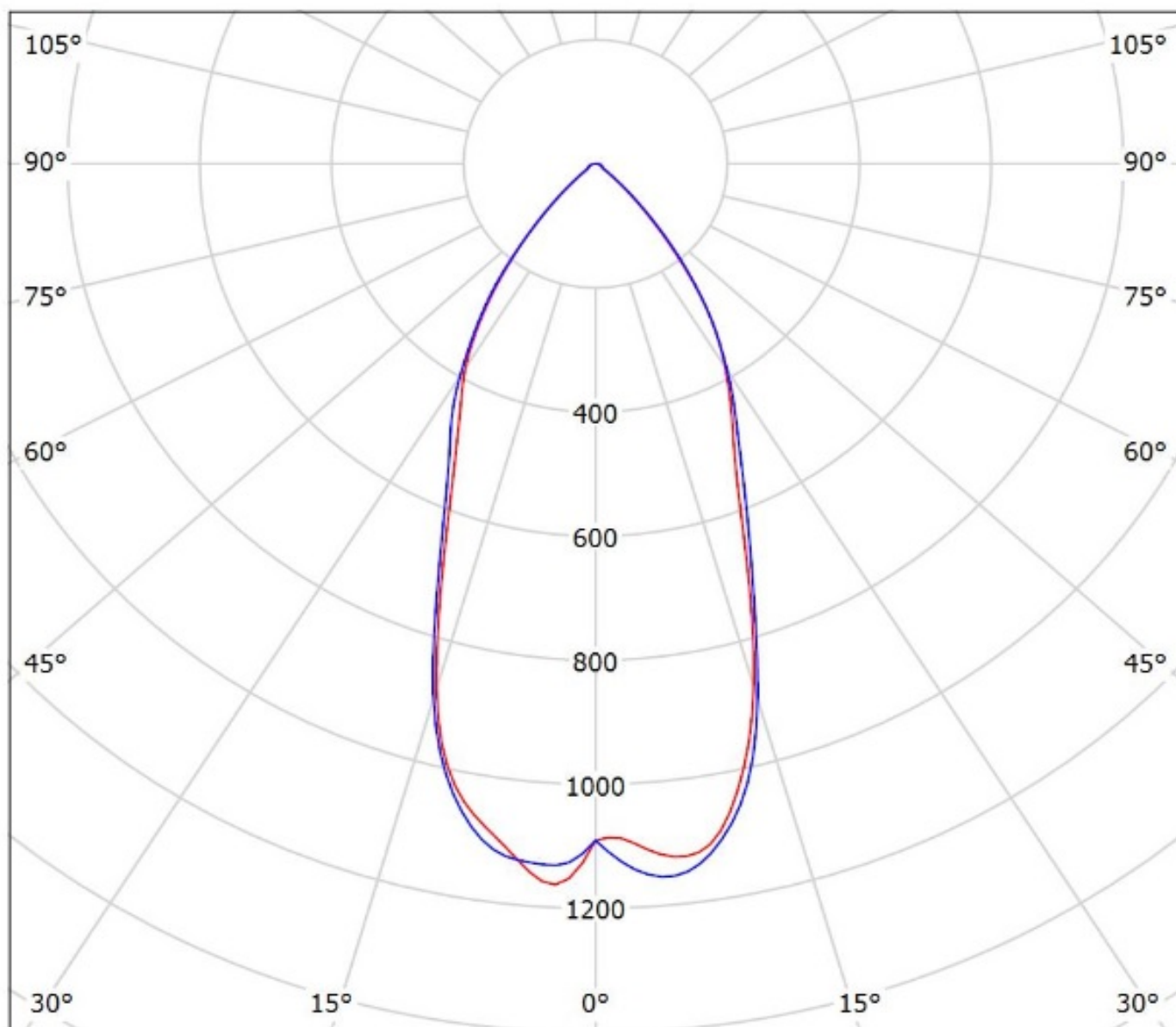

cd/klm

— C0 - C180 — C90 - C270

$\eta = 91\%$

Luminaire: Ledil Oy CN14238_WINNIE-W_(LC020C)_(B+W_479_Typ_L5)_SIMULATED
Lamps: 1 x Samsung LC020C

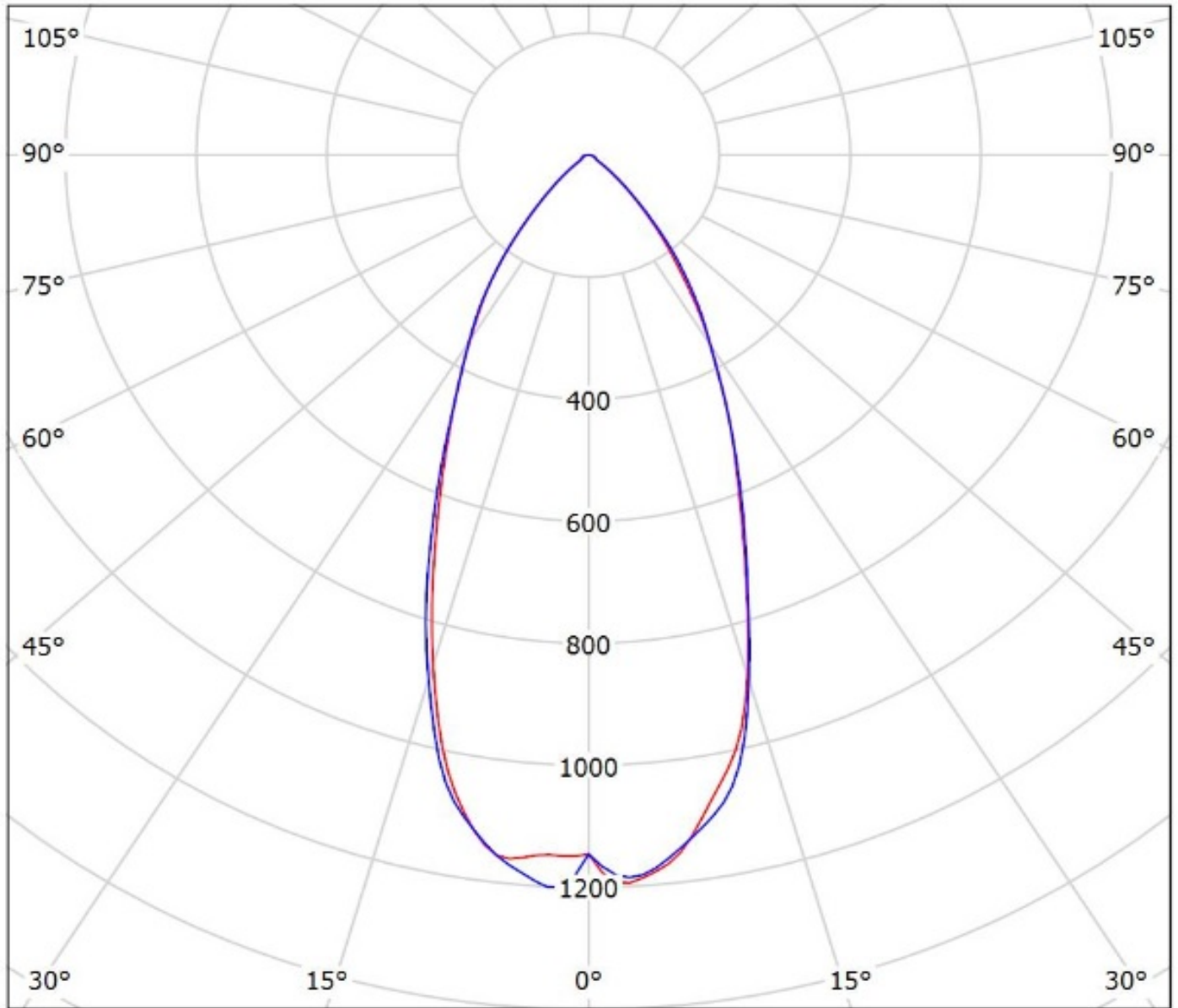

cd/klm

— C0 - C180 — C90 - C270

$\eta = 89\%$

Luminaire: Ledil Oy CN14238_WINNIE-W_(LC040C)_(B+W_479_Typ_L5)_SIMULATED
Lamps: 1 x Samsung LC040C

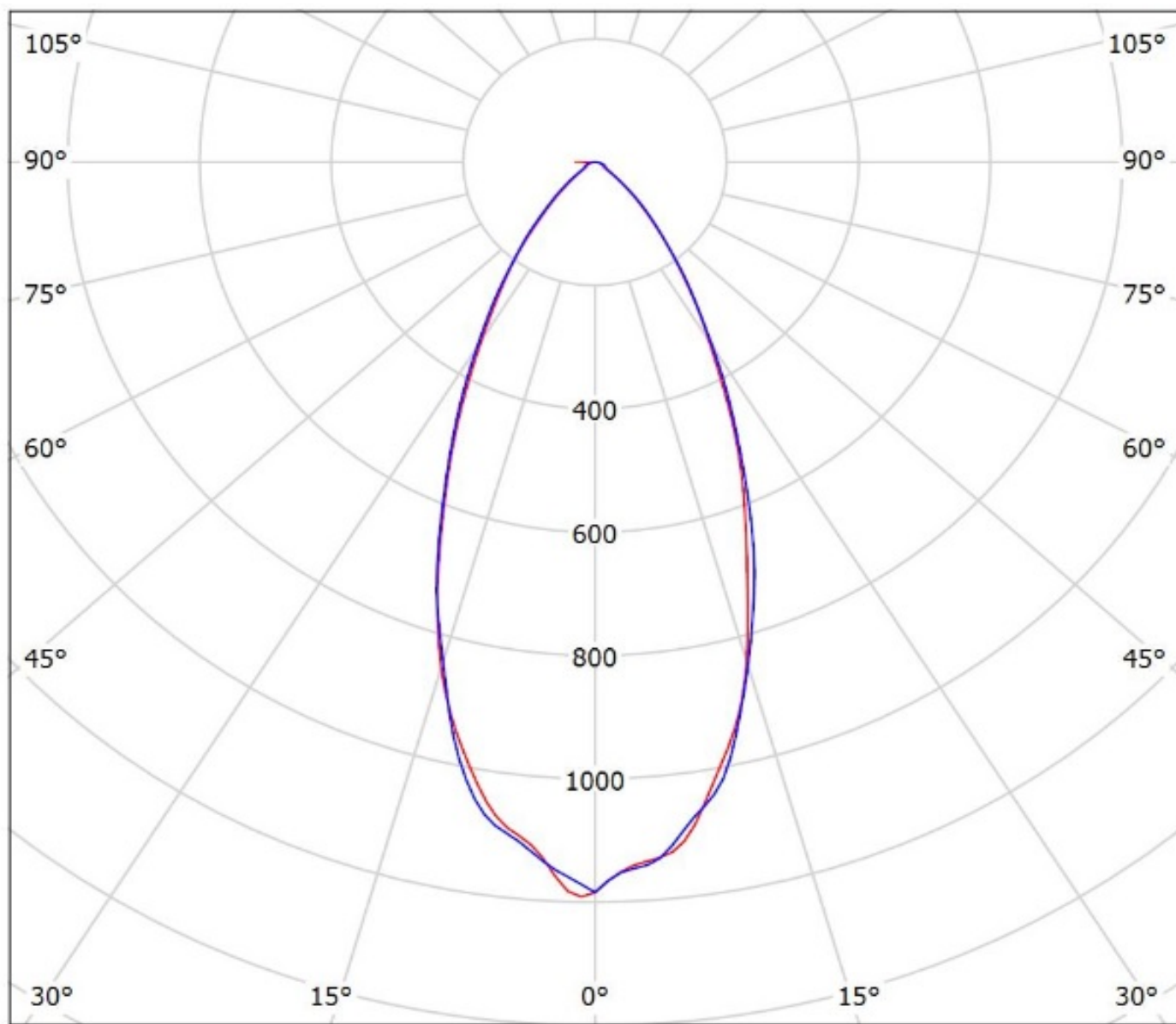

cd/klm

— C0 - C180 — C90 - C270

$\eta = 88\%$

Luminaire: LEDiL Oy CN14238_WINNIE-W_(COB_D_series_LES_9.8mm)

Lamps: 1 x Samsung_COB_D_series_LES_9.8mm_LC013D_551.044lm@100mA_P=3.2212W_I=0.100A

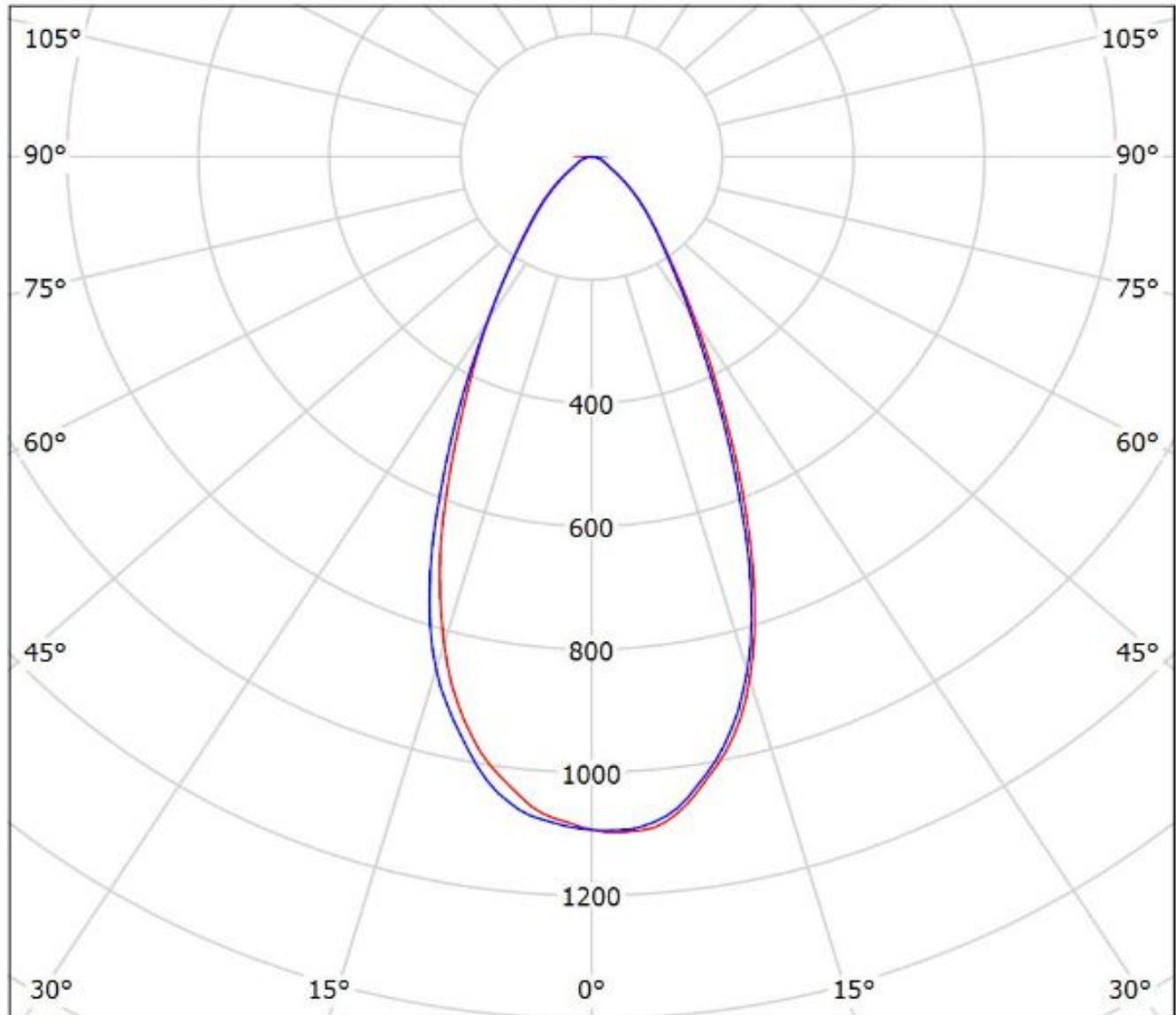

cd/klm

— C0 - C180 — C90 - C270

$\eta = 88\%$

Luminaire: LEDiL Oy CN14238_WINNIE-W_(COB_D_LES-14,5mm)

Lamps: 1 x Samsung_COB_D_Series-LES-14,5_LC026D_1272.15lm@250mA_P=8.07678W_I=0.250A

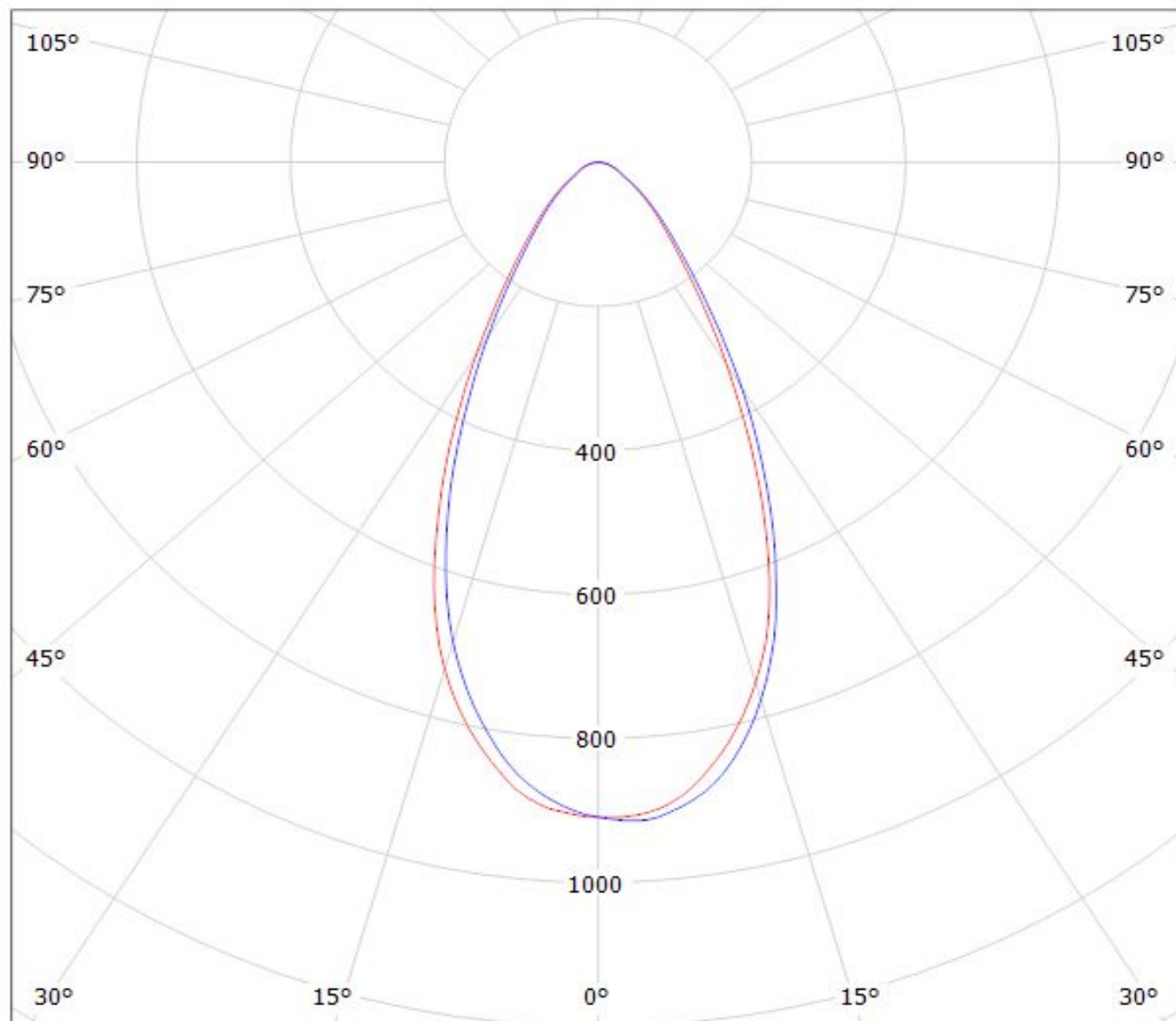

cd/klm

— C0 - C180

— C90 - C270

$\eta = 85\%$

Luminaire: LEDiL Oy CN14238_WINNIE-W_(ZC12)

Lamps: 1 x Seoul_ZC12_(SDW82F1C)_+_B+W_433_Typ_L5_1217.21lm@250mA_P=8.64733W_I=250mA

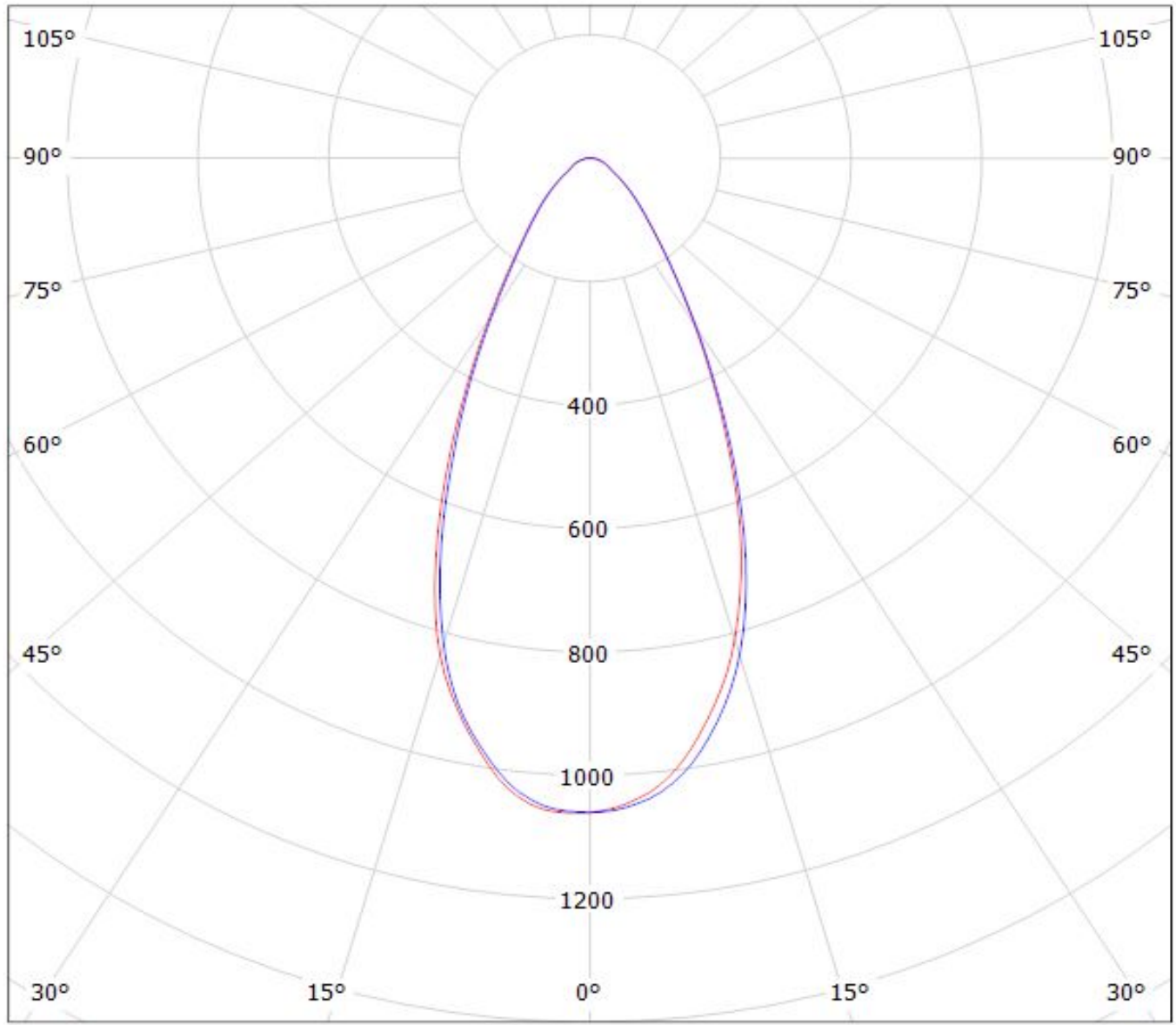

cd/klm

— C0 - C180

— C90 - C270

$\eta = 89\%$

Luminaire: Ledil CN14238_WINNIE-W_(MJT_12W_Les9,8)

Lamps: 1 x Seoul_MJT_12W_Les9.8mm_(SAWx1063A)_1271.35lm@250mA_P=8.45475W_I=0.25A

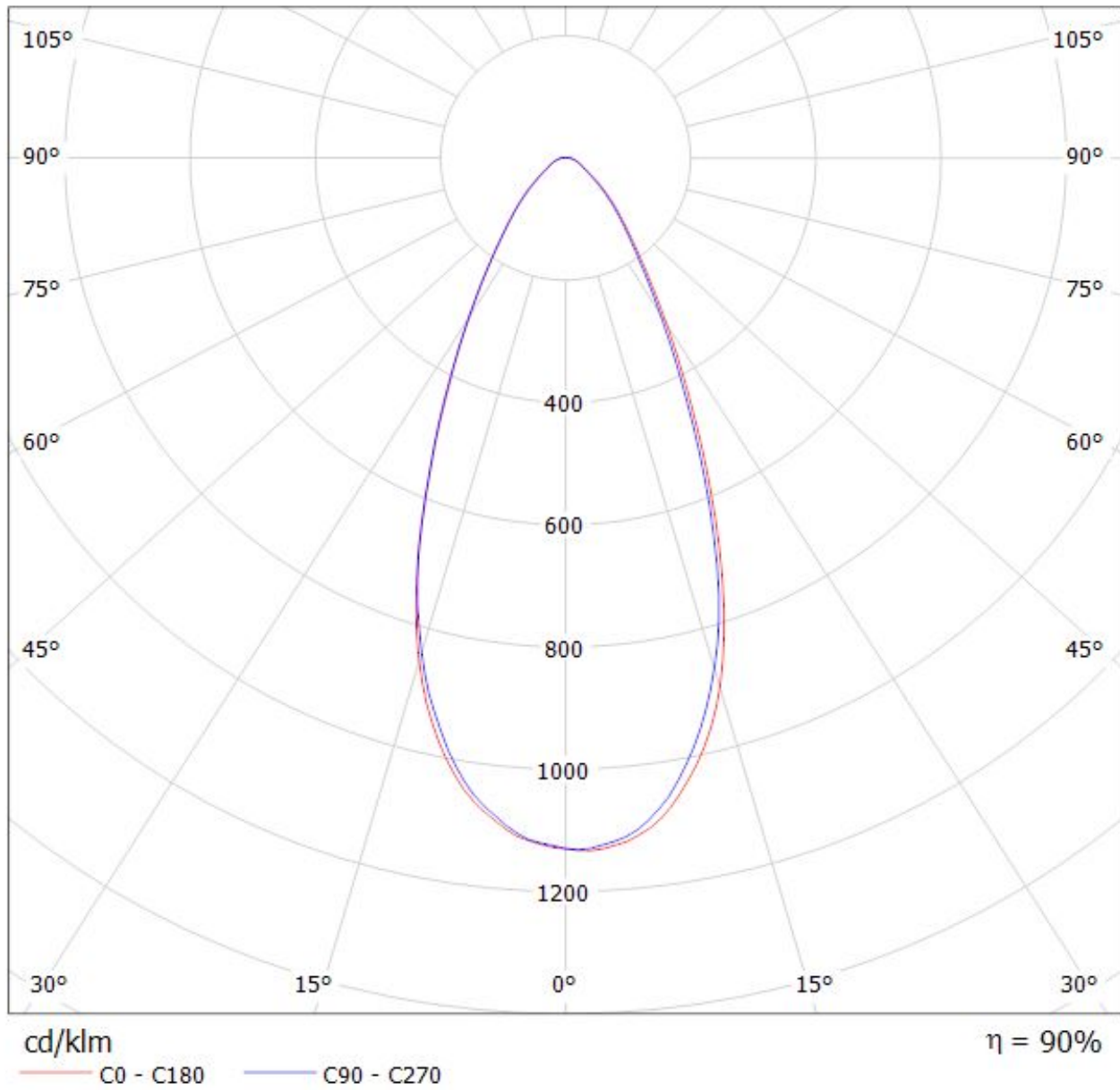

Luminaire: Ledil CN14238_WINNIE-W_(MJT_30W_Les14,5)_+433_Typ_L5

Lamps: 1 x Seoul_MJT_30W_Les14,5mm_(SAWx1566A)_+433_Typ_L5_1352.83lm@250mA_P=8.2325W_I=0.25A

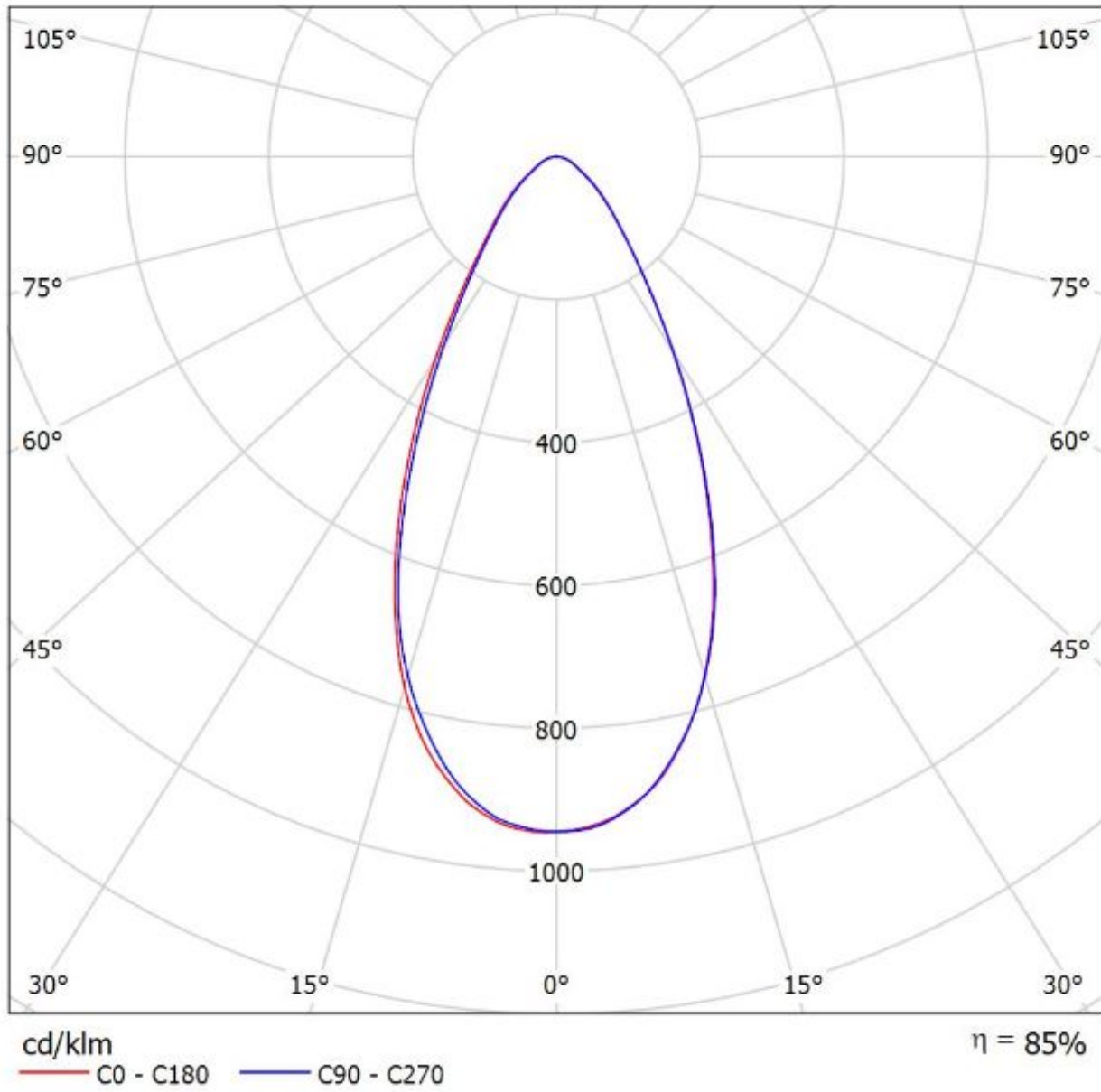

Luminaire: LEDiL Oy CN14238_WINNIE-W_(SLE-G5_LES-6)

Lamps: 1 x Tridonic_SLE-G5_LES-6_472.41lm@100mA_P=3.3763W_I=0.100A

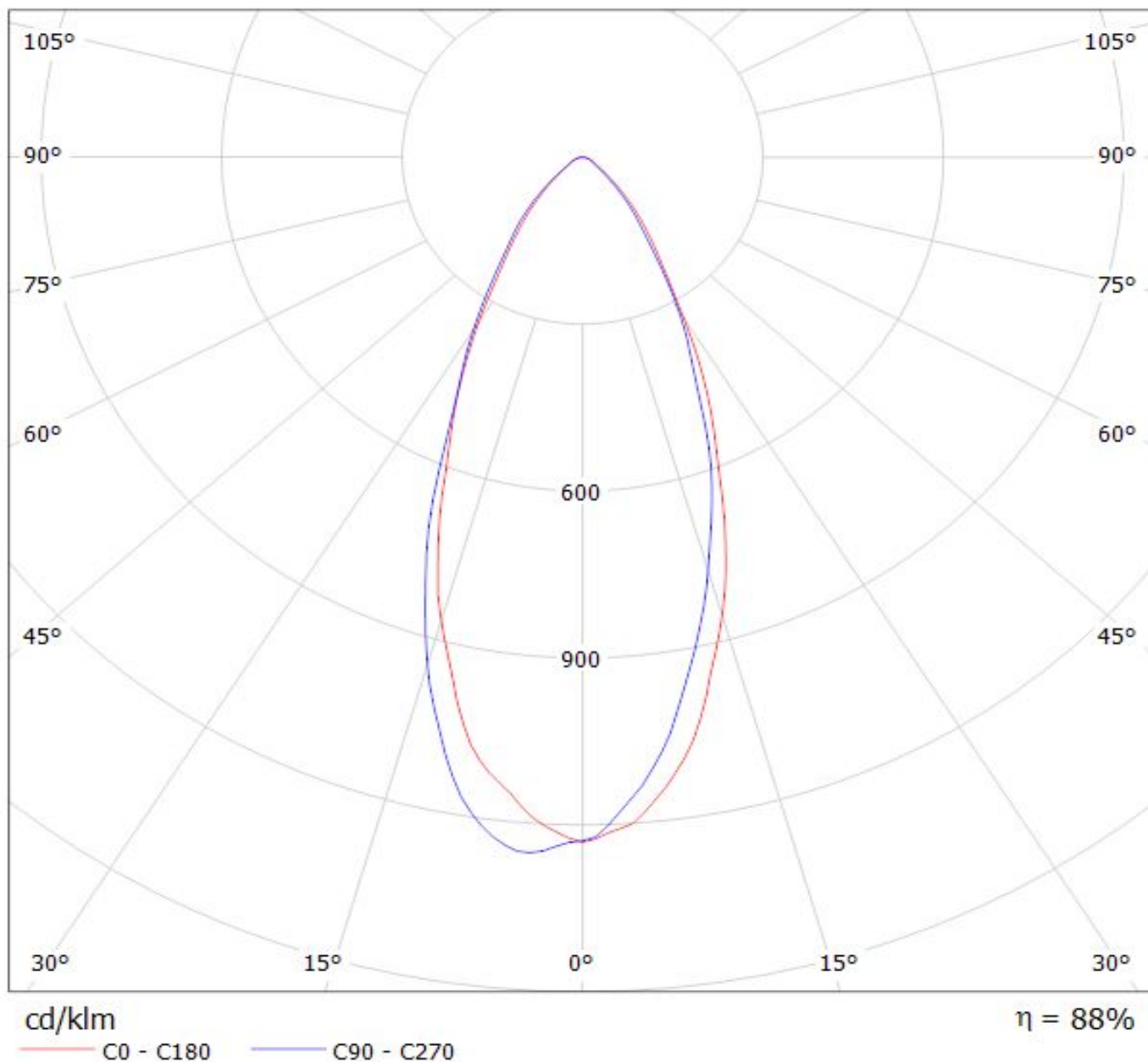

Luminaire: LEDiL Oy CN14238_WINNIE-W_(SLE-G5_LES-11)

Lamps: 1 x Tridonic_SLE-G5_LES-15_1138.42lm@250mA_P=8.4110W_I=0.250A

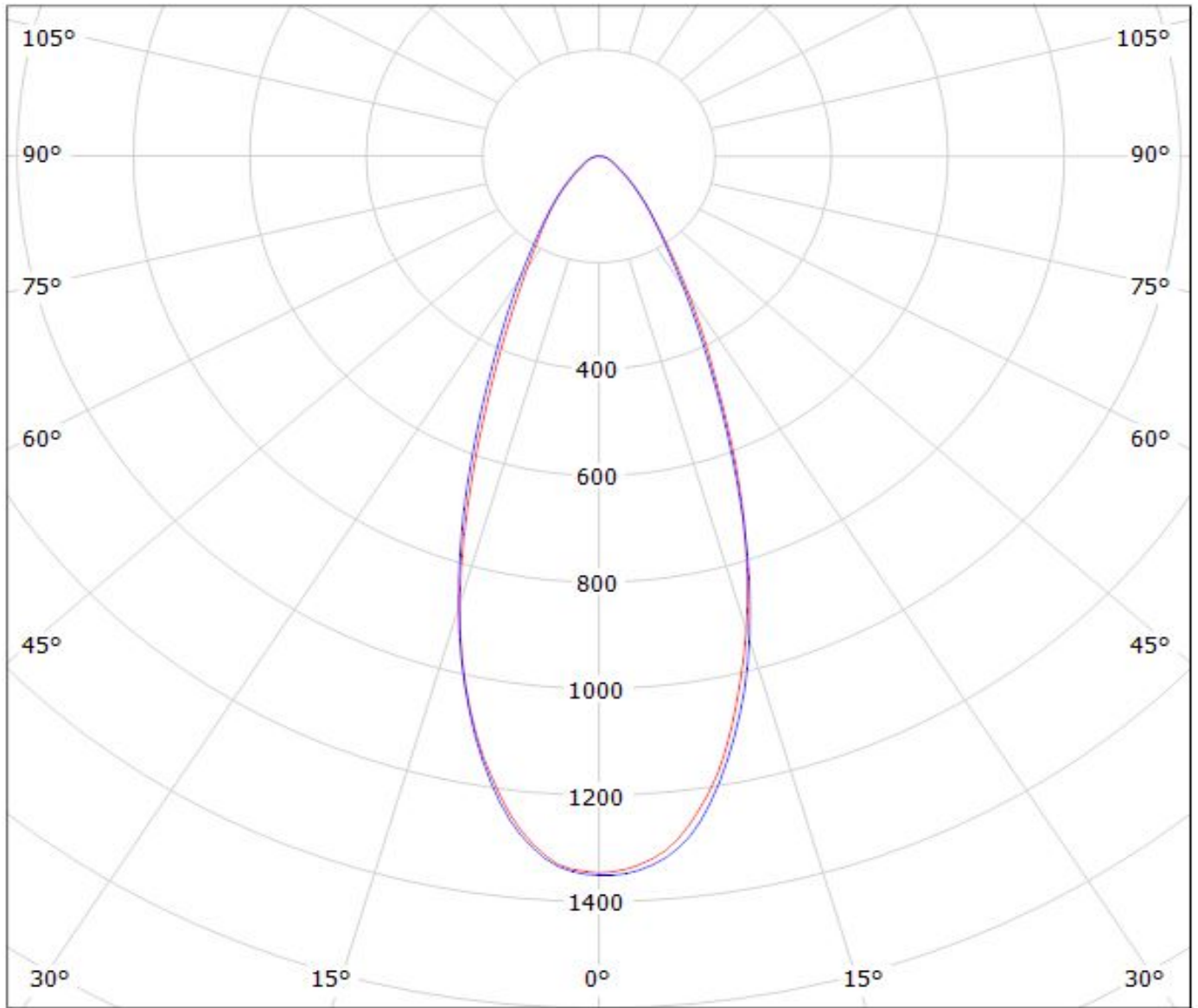

cd/klm

— C0 - C180

— C90 - C270

$\eta = 86\%$

Luminaire: LEDiL Oy CN14238_WINNIE-W_(SLE-G5_LES-15)

Lamps: 1 x Tridonic_SLE-G5_LES-15_1267.45lm@250mA_P=8.6695W_η=0.250A

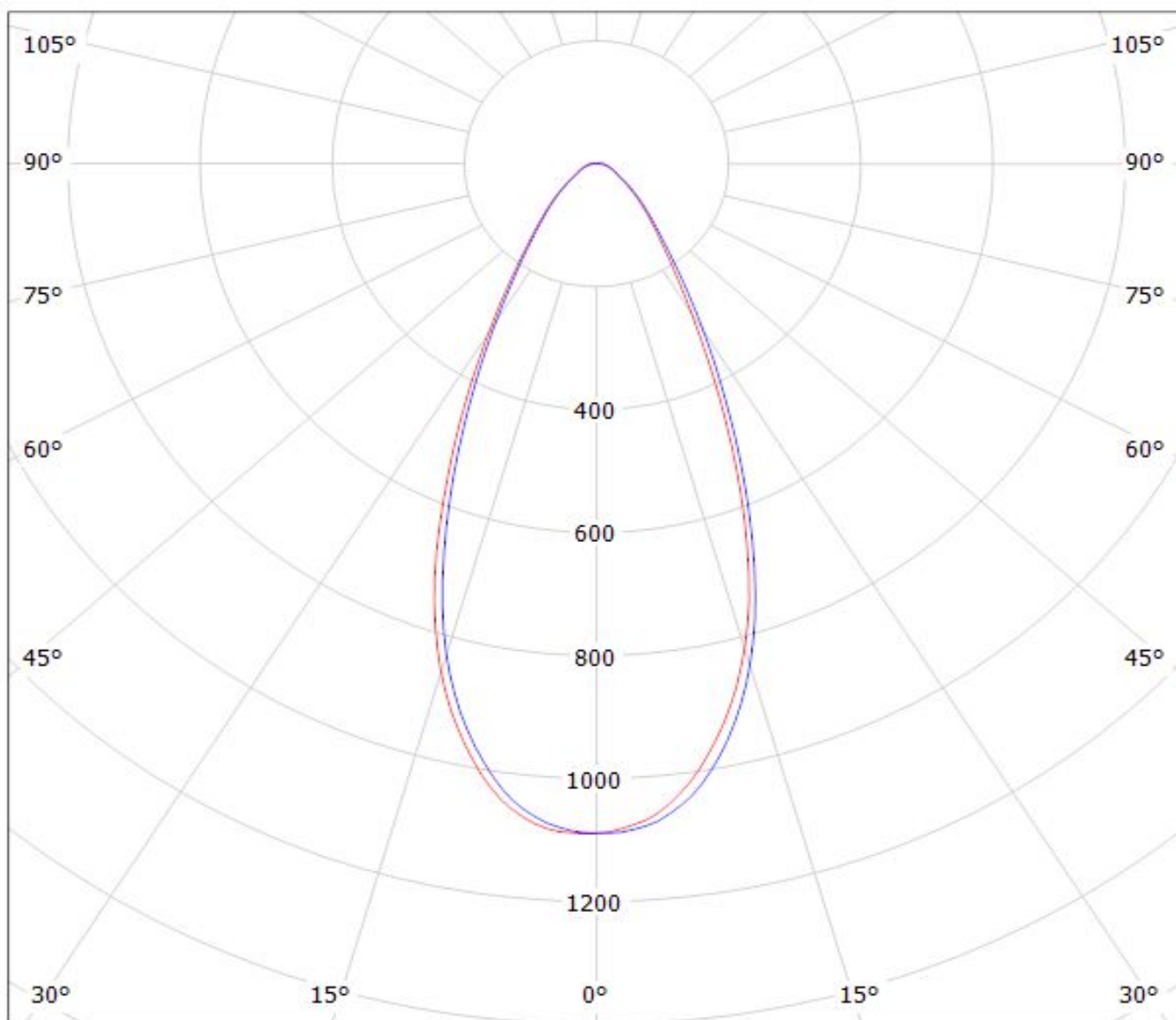

cd/klm

— C0 - C180

— C90 - C270

η = 89%

Luminaire: Ledil Oy CN14238_WINNIE-W_(SLE_G6_LES15)_ (433_Typ_L5)_SIMULATED
Lamps: 1 x Tridonic SLE G5 LES15 + Bender & Wirth 433 Typ L5

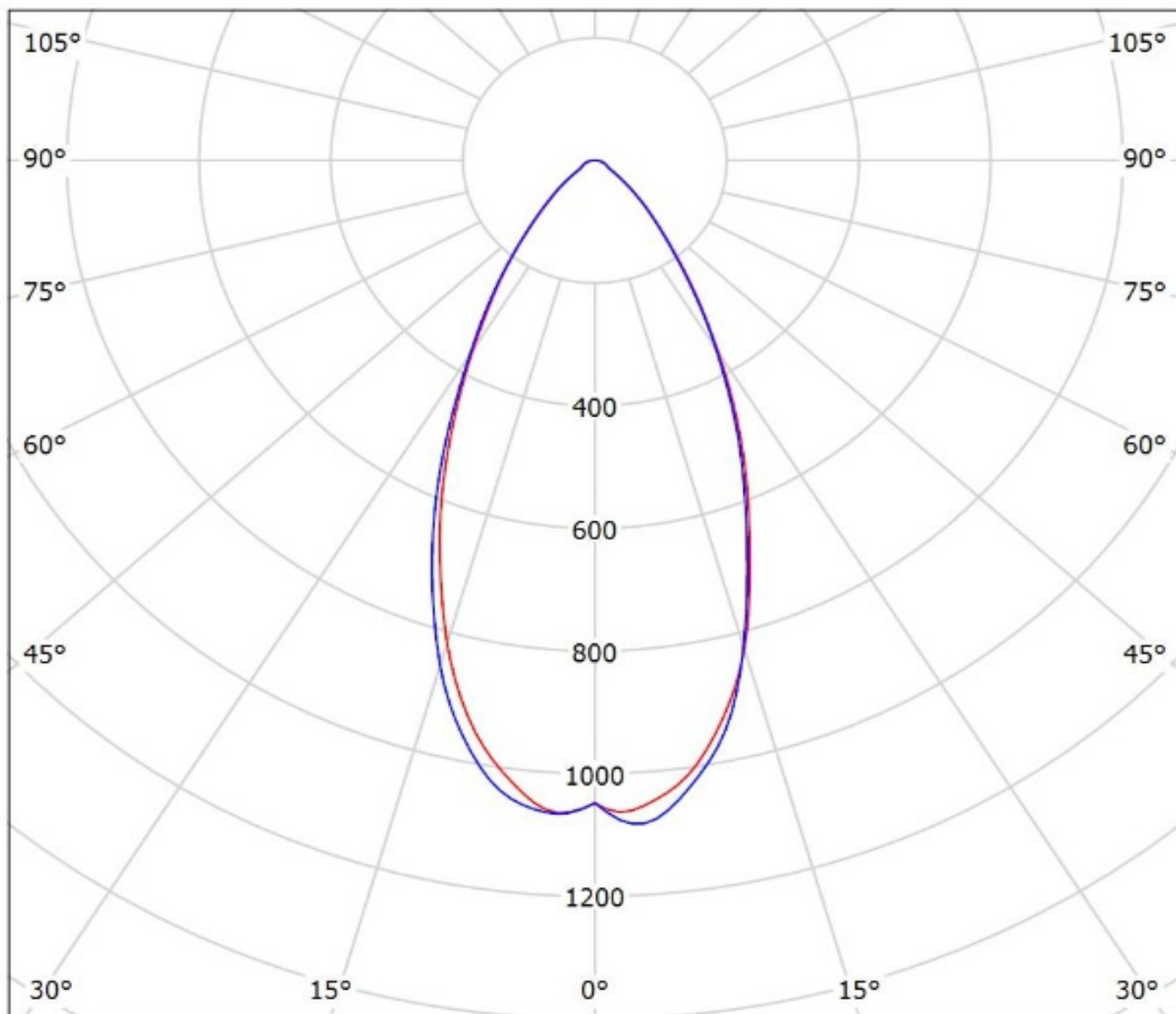

cd/klm

— C0 - C180 — C90 - C270

$\eta = 92\%$

Luminaire: Ledil Oy CN14238_WINNIE-W+_B+W_433_Typ_L5_TRIDONIC_SLE_G6_LES17_SIMULATED
Lamps: 1 x TRIDONIC SLE G6 LES17

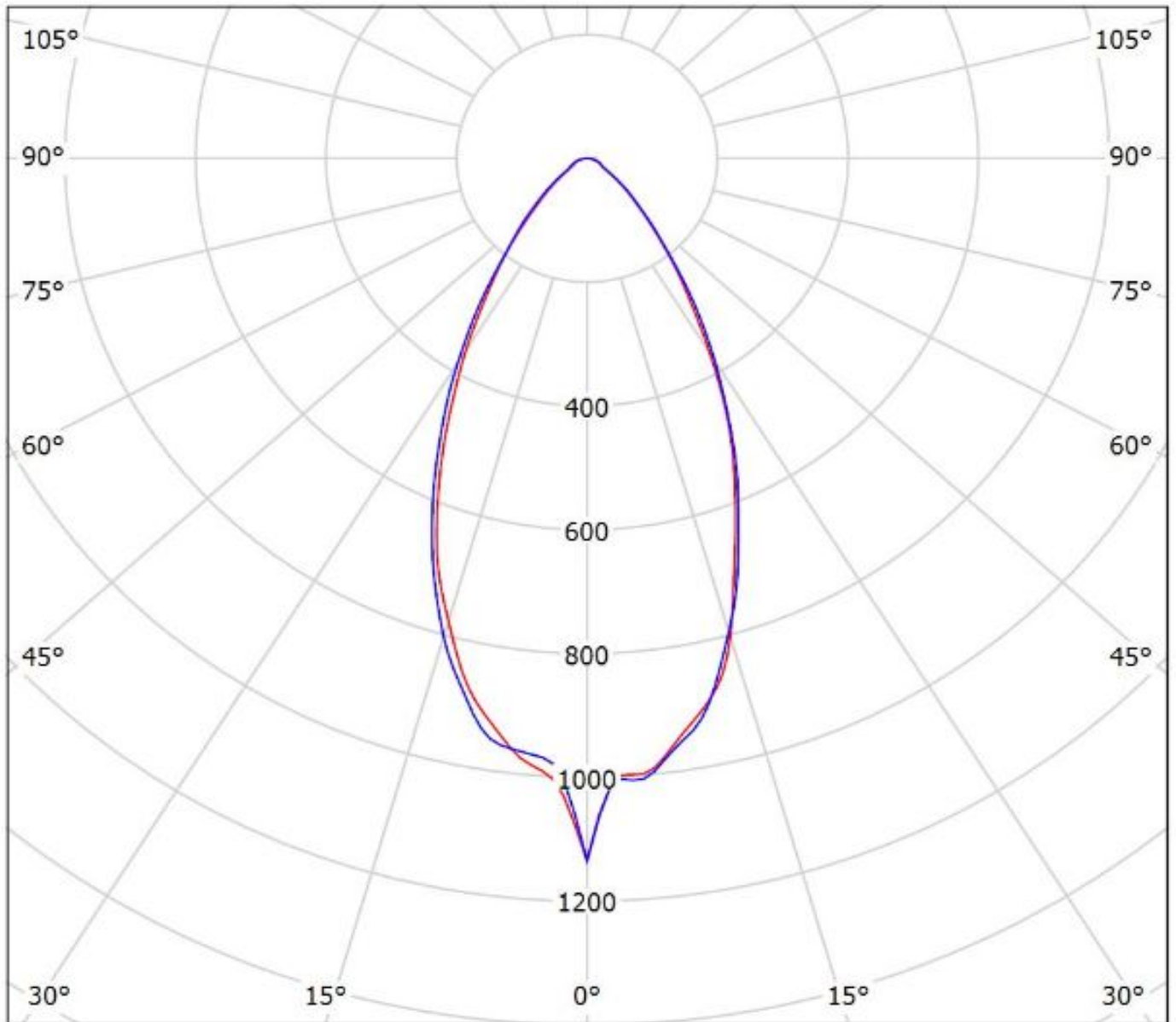

cd/klm

— C0 - C180 — C90 - C270

$\eta = 92\%$

Luminaire: LEDiL Oy CN14238_WINNIE-W_(DMC125)

Lamps: 1 x DMC125+433_Typ_L5_1101.77lm@250mA_P=8.53017W_I=250mA

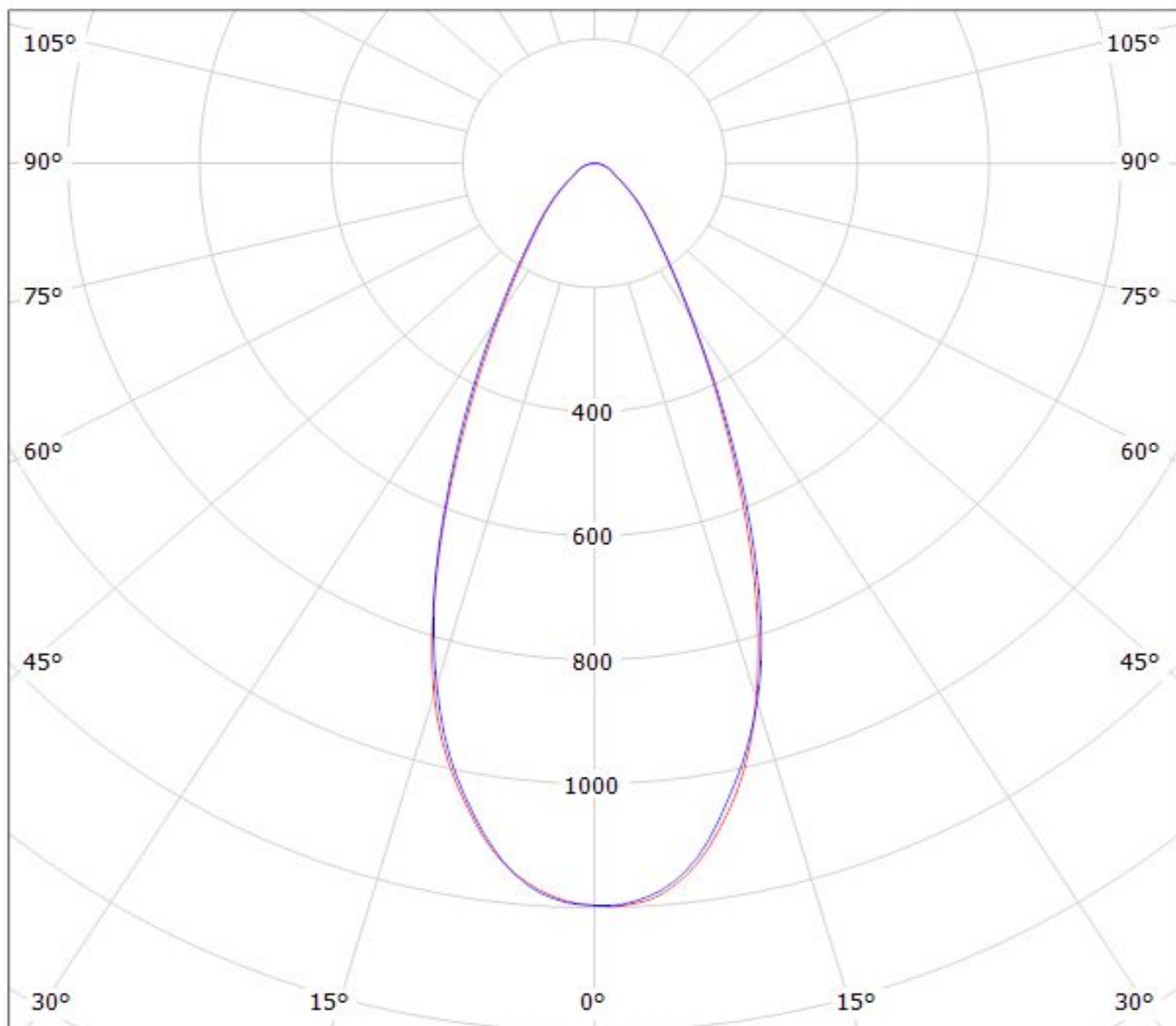

cd/klm

— C0 - C180

— C90 - C270

$\eta = 89\%$

Luminaire: LEDiL Oy CN14238_WINNIE-W_(DMC128)

Lamps: 1 x DMC128+433_TYP_L5_825.549lm@250mA_P=8.28162W_I=250mA

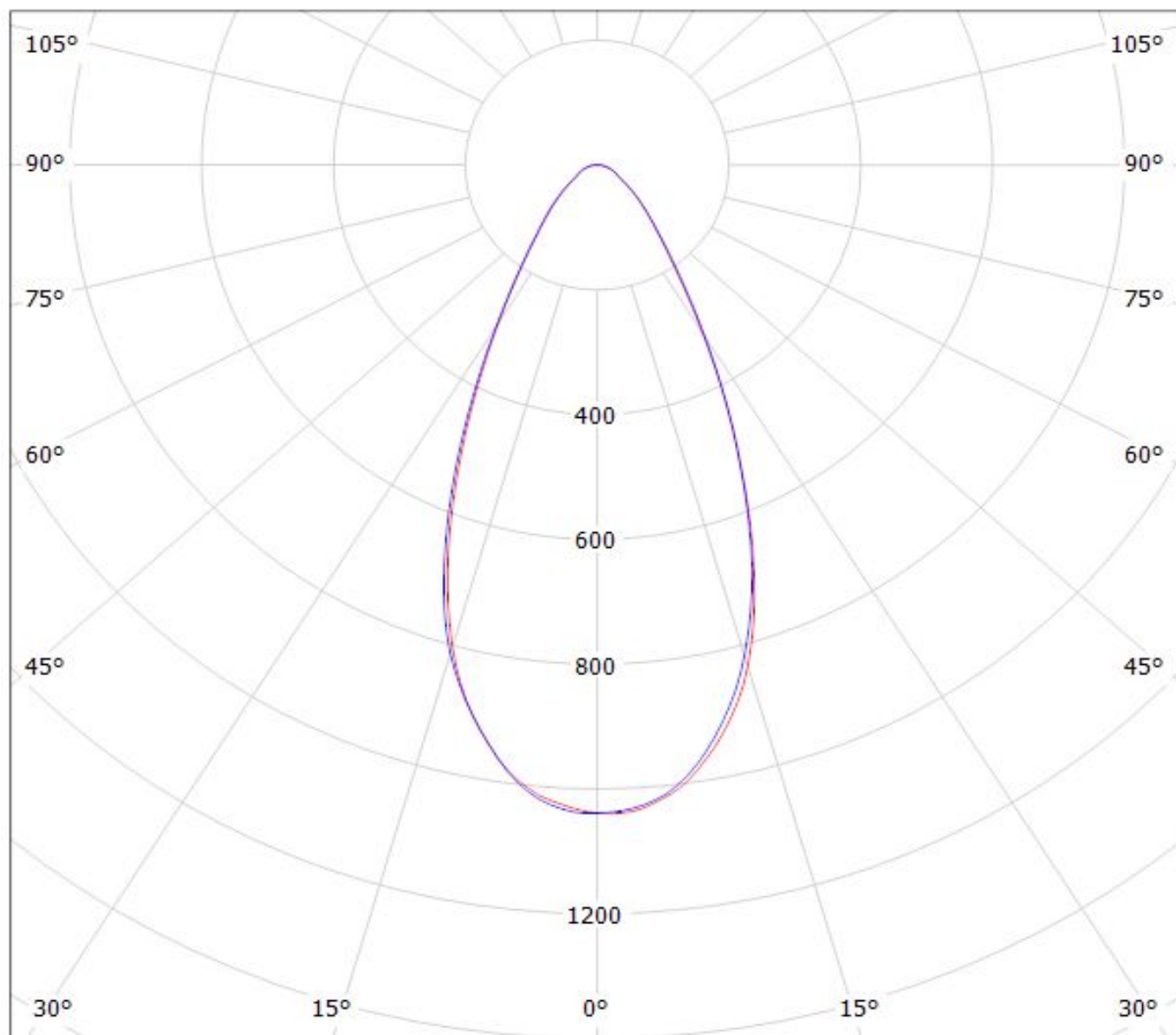

cd/klm

— C0 - C180

— C90 - C270

$\eta = 88\%$

NOTE: The typical divergence will be changed by different color, chip size and chip position tolerance. The typical total divergence is the full angle measured where the luminous intensity is half of the peak value.

GENERAL INFORMATION

- Product series especially designed & optimized for series of LEDs.
- Special care taken to make light distribution as uniform as possible.

Note! Due to use of high power COB's with this product, special attention to proper thermal design is highly recommended. LEDiL has no liability for direct, indirect or consecutive damages arising from the LEDiL products being used outside of the recommended temperature range.