

International  
**IR** Rectifier  
**RADIATION HARDENED  
 POWER MOSFET  
 SURFACE MOUNT (LCC-18)**

PD - 90713F

**IRHE7230  
 JANSR2N7262U  
 200V, N-CHANNEL  
 REF: MIL-PRF-19500/601  
 RAD-Hard™ HEXFET® TECHNOLOGY**

**Product Summary**

Part Number	Radiation Level	RDS(on)	ID	QPL Part Number
IRHE7230	100K Rads (Si)	0.35Ω	5.5A	JANSR2N7262U
IRHE3230	300K Rads (Si)	0.35Ω	5.5A	JANSF2N7262U
IRHE4230	500K Rads (Si)	0.35Ω	5.5A	JANSG2N7262U
IRHE8230	1000K Rads (Si)	0.35Ω	5.5A	JANSH2N7262U

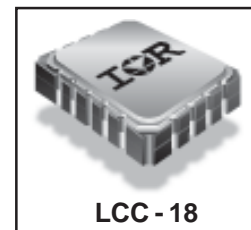

International Rectifier's RAD-Hard™ HEXFET® technology provides high performance power MOSFETs for space applications. This technology has over a decade of proven performance and reliability in satellite applications. These devices have been characterized for both Total Dose and Single Event Effects (SEE). The combination of low Rds(on) and low gate charge reduces the power losses in switching applications such as DC to DC converters and motor control. These devices retain all of the well established advantages of MOSFETs such as voltage control, fast switching, ease of paralleling and temperature stability of electrical parameters.

**Features:**

- Single Event Effect (SEE) Hardened
- Low RDS(on)
- Low Total Gate Charge
- Simple Drive Requirements
- Ease of Paralleling
- Hermetically Sealed
- Surface Mount
- Light Weight

**Absolute Maximum Ratings**

**Pre-Irradiation**

	Parameter		Units
ID @ VGS = 12V, TC = 25°C	Continuous Drain Current	5.5	A
ID @ VGS = 12V, TC = 100°C	Continuous Drain Current	3.5	
IDM	Pulsed Drain Current ①	22	
PD @ TC = 25°C	Max. Power Dissipation	25	W
	Linear Derating Factor	0.2	W/°C
VGS	Gate-to-Source Voltage	±20	V
EAS	Single Pulse Avalanche Energy ②	240	mJ
IAR	Avalanche Current ①	5.5	A
EAR	Repetitive Avalanche Energy ①	2.5	mJ
dv/dt	Peak Diode Recovery dv/dt ③	5.0	V/ns
TJ	Operating Junction	-55 to 150	°C
TSTG	Storage Temperature Range		
	Pckg. Mounting Surface Temp.	300 ( for 5s)	
	Weight	0.42 (Typical)	

For footnotes refer to the last page

www.irf.com

**Electrical Characteristics @ T<sub>j</sub> = 25°C (Unless Otherwise Specified)**

	Parameter	Min	Typ	Max	Units	Test Conditions
BV <sub>DSS</sub>	Drain-to-Source Breakdown Voltage	200	—	—	V	V <sub>GS</sub> = 0 V, I <sub>D</sub> = 1.0mA
ΔBV <sub>DSS</sub> /ΔT <sub>J</sub>	Temperature Coefficient of Breakdown Voltage	—	0.25	—	V/°C	Reference to 25°C, I <sub>D</sub> = 1.0mA
R <sub>DSON</sub>	Static Drain-to-Source On-State Resistance	—	—	0.35	Ω	V <sub>GS</sub> = 12V, I <sub>D</sub> = 3.5A
		—	—	0.36		V <sub>GS</sub> = 12V, I <sub>D</sub> = 5.5A ④
V <sub>GS(th)</sub>	Gate Threshold Voltage	2.0	—	4.0	V	V <sub>DS</sub> = V <sub>GS</sub> , I <sub>D</sub> = 1.0mA
g <sub>fs</sub>	Forward Transconductance	2.5	—	—	S (r̄)	V <sub>DS</sub> > 15V, I <sub>DS</sub> = 3.5A ④
I <sub>DSS</sub>	Zero Gate Voltage Drain Current	—	—	25	μA	V <sub>DS</sub> = 160V, V <sub>GS</sub> = 0V
		—	—	250		V <sub>DS</sub> = 160V V <sub>GS</sub> = 0V, T <sub>J</sub> = 125°C
I <sub>GSS</sub>	Gate-to-Source Leakage Forward	—	—	100	nA	V <sub>GS</sub> = 20V
I <sub>GSS</sub>	Gate-to-Source Leakage Reverse	—	—	-100		V <sub>GS</sub> = -20V
Q <sub>g</sub>	Total Gate Charge	—	—	50	nC	V <sub>GS</sub> = 12V, I <sub>D</sub> = 5.5A
Q <sub>gs</sub>	Gate-to-Source Charge	—	—	10		V <sub>DS</sub> = 100V
Q <sub>gd</sub>	Gate-to-Drain ('Miller') Charge	—	—	25		
t <sub>d(on)</sub>	Turn-On Delay Time	—	—	25	ns	V <sub>DD</sub> = 100V, I <sub>D</sub> = 5.5A, V <sub>GS</sub> = 12V, R <sub>G</sub> = 7.5Ω
t <sub>r</sub>	Rise Time	—	—	40		
t <sub>d(off)</sub>	Turn-Off Delay Time	—	—	60		
t <sub>f</sub>	Fall Time	—	—	45		
L <sub>S</sub> + L <sub>D</sub>	Total Inductance	—	6.1	—	nH	Measured from drain lead (6mm/0.25in. from package) to source lead (6mm/0.25in. from package)
C <sub>iss</sub>	Input Capacitance	—	1100	—	pF	V <sub>GS</sub> = 0V, V <sub>DS</sub> = 25V f = 1.0MHz
C <sub>oss</sub>	Output Capacitance	—	250	—		
C <sub>rss</sub>	Reverse Transfer Capacitance	—	55	—		

**Source-Drain Diode Ratings and Characteristics**

	Parameter	Min	Typ	Max	Units	Test Conditions
I <sub>S</sub>	Continuous Source Current (Body Diode)	—	—	5.5	A	
I <sub>SM</sub>	Pulse Source Current (Body Diode) ①	—	—	22		
V <sub>SD</sub>	Diode Forward Voltage	—	—	1.4	V	T <sub>J</sub> = 25°C, I <sub>S</sub> = 5.5A, V <sub>GS</sub> = 0V ④
t <sub>rr</sub>	Reverse Recovery Time	—	—	400	ns	T <sub>J</sub> = 25°C, I <sub>F</sub> = 5.5A, di/dt ≤ 100A/μs
Q <sub>RR</sub>	Reverse Recovery Charge	—	—	3.0	μC	V <sub>DD</sub> ≤ 25V ④
t <sub>on</sub>	Forward Turn-On Time	Intrinsic turn-on time is negligible. Turn-on speed is substantially controlled by L <sub>S</sub> + L <sub>D</sub> .				

**Thermal Resistance**

	Parameter	Min	Typ	Max	Units	Test Conditions
R <sub>thJC</sub>	Junction-to-Case	—	—	5.0	°C/W	Solder to a copper clad PC Board
R <sub>thJPCB</sub>	Junction-to-PC Board	—	19	—		

**Note:** Corresponding Spice and Saber models are available on the International Rectifier Website.

For footnotes refer to the last page

## Radiation Characteristics

## IRHE7230, JANSR2N7262U

International Rectifier Radiation Hardened MOSFETs are tested to verify their radiation hardness capability. The hardness assurance program at International Rectifier is comprised of two radiation environments. Every manufacturing lot is tested for total ionizing dose (per notes 5 and 6) using the TO-3 package. Both pre- and post-irradiation performance are tested and specified using the same drive circuitry and test conditions in order to provide a direct comparison.

**Table 1. Electrical Characteristics @ Tj = 25°C, Post Total Dose Irradiation** <sup>⑤⑥</sup>

	Parameter	100K Rads(Si) <sup>1</sup>		300K - 1000K Rads (Si) <sup>2</sup>		Units	Test Conditions
		Min	Max	Min	Max		
BV <sub>DSS</sub>	Drain-to-Source Breakdown Voltage	200	—	200	—	V	V <sub>GS</sub> = 0V, I <sub>D</sub> = 1.0mA
V <sub>GS(th)</sub>	Gate Threshold Voltage	2.0	4.0	1.25	4.5		V <sub>GS</sub> = V <sub>DS</sub> , I <sub>D</sub> = 1.0mA
I <sub>GSS</sub>	Gate-to-Source Leakage Forward	—	100	—	100	nA	V <sub>GS</sub> = 20V
I <sub>GSS</sub>	Gate-to-Source Leakage Reverse	—	-100	—	-100		V <sub>GS</sub> = -20 V
I <sub>DSS</sub>	Zero Gate Voltage Drain Current	—	25	—	50	μA	V <sub>DS</sub> =160V, V <sub>GS</sub> =0V
R <sub>DS(on)</sub>	Static Drain-to-Source <sup>④</sup> On-State Resistance (TO-3)	—	0.35	—	0.48	Ω	V <sub>GS</sub> = 12V, I <sub>D</sub> =3.5A
R <sub>DS(on)</sub>	Static Drain-to-Source <sup>④</sup> On-State Resistance (LCC-18)	—	0.35	—	0.48	Ω	V <sub>GS</sub> = 12V, I <sub>D</sub> =3.5A
V <sub>SD</sub>	Diode Forward Voltage <sup>④</sup>	—	1.4	—	1.4	V	V <sub>GS</sub> = 0V, I <sub>S</sub> = 5.5A

1. Part number IRHE7230 (JANSR2N7262U)

2. Part numbers IRHE3230 (JANSF2N7262U), IRHE4230 (JANS G2N7262U) and IRHE8230 (JANS H2N7262U)

International Rectifier radiation hardened MOSFETs have been characterized in heavy ion environment for Single Event Effects (SEE). Single Event Effects characterization is illustrated in Fig. a and Table 2.

Ion	LET (MeV/(mg/cm <sup>2</sup> ))	Energy (MeV)	Range (μm)	V <sub>DS</sub> (V)				
				@V <sub>GS</sub> =0V	@V <sub>GS</sub> =-5V	@V <sub>GS</sub> =-10V	@V <sub>GS</sub> =-15V	@V <sub>GS</sub> =-20V
Cu	28	285	43	190	180	170	125	—
Br	36.8	305	39	100	100	100	50	—

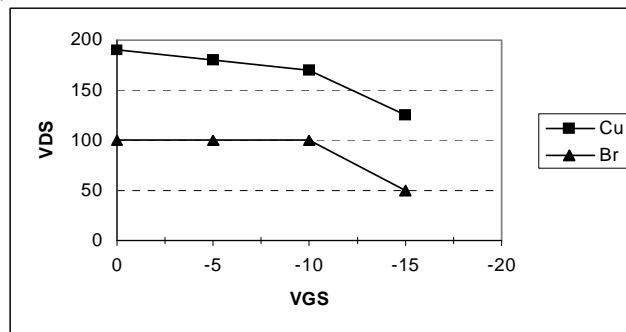

**Fig a.** Single Event Effect, Safe Operating Area

For footnotes refer to the last page

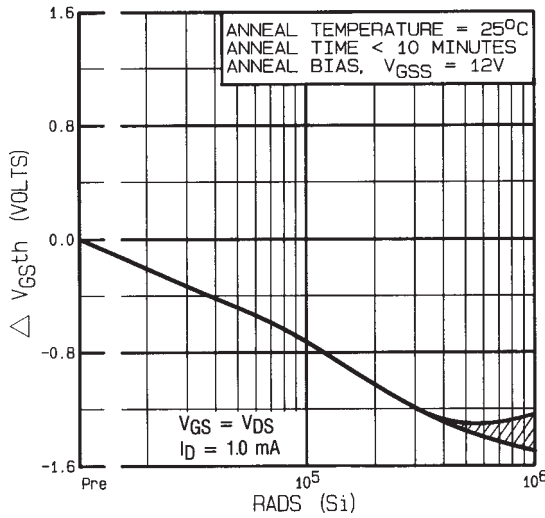

Fig 1. Typical Response of Gate Threshold Voltage Vs. Total Dose Exposure

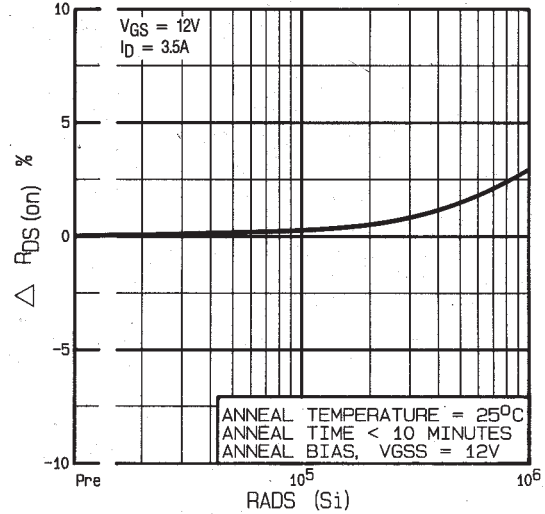

Fig 2. Typical Response of On-State Resistance Vs. Total Dose Exposure

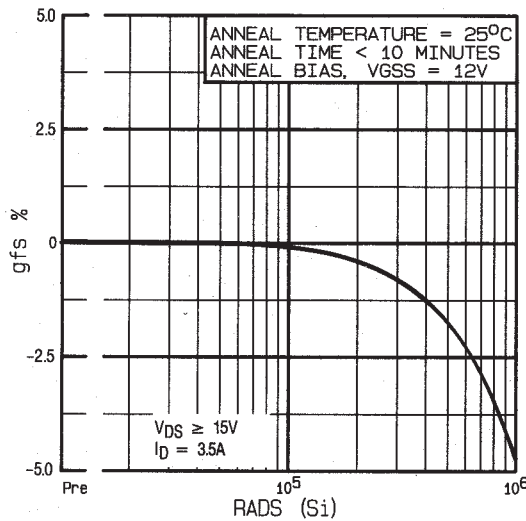

Fig 3. Typical Response of Transconductance Vs. Total Dose Exposure

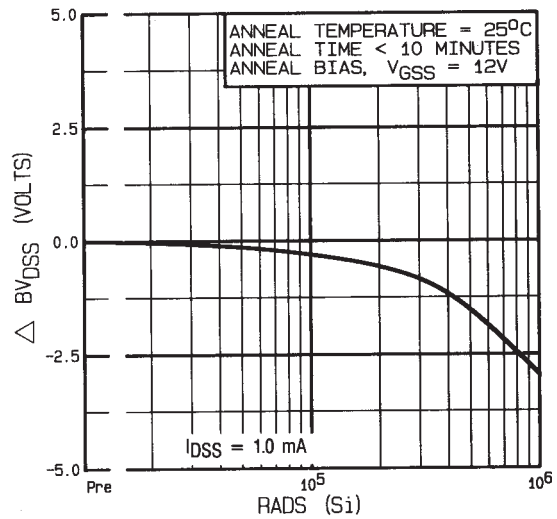

Fig 4. Typical Response of Drain to Source Breakdown Vs. Total Dose Exposure

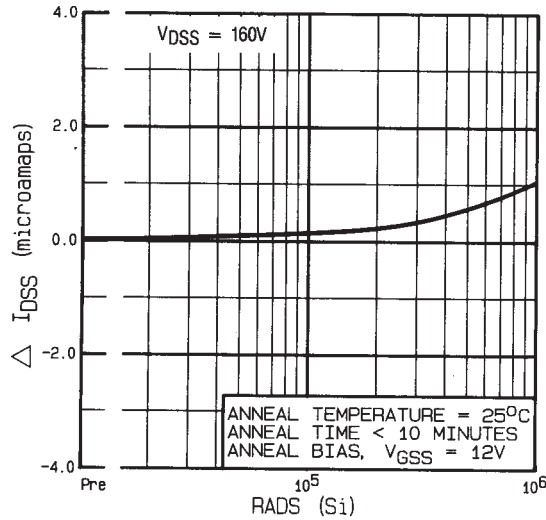

Fig 5. Typical Zero Gate Voltage Drain Current Vs. Total Dose Exposure

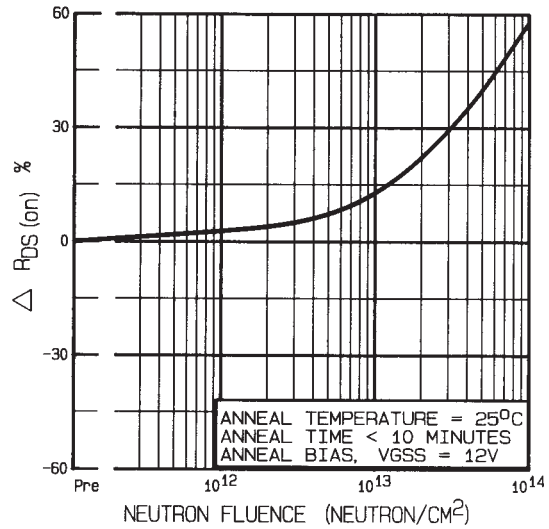

Fig 6. Typical On-State Resistance Vs. Neutron Fluence Level

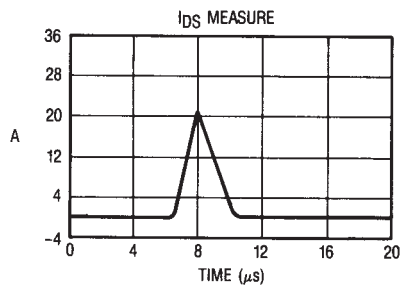
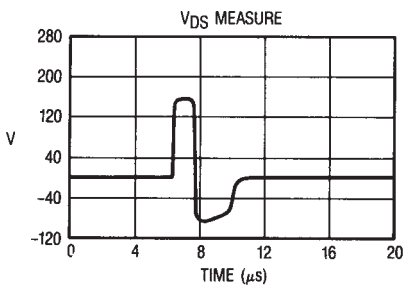

Fig 7. Typical Transient Response of Rad Hard HEXFET During  $1 \times 10^{12}$  Rad (Si)/Sec Exposure

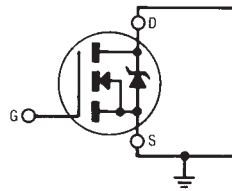

Fig 8a. Gate Stress of  $V_{GSS}$  Equals 12 Volts During Radiation

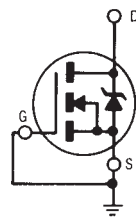

Fig 8b.  $V_{DSS}$  Stress Equals 80% of  $B_{V_{DSS}}$  During Radiation

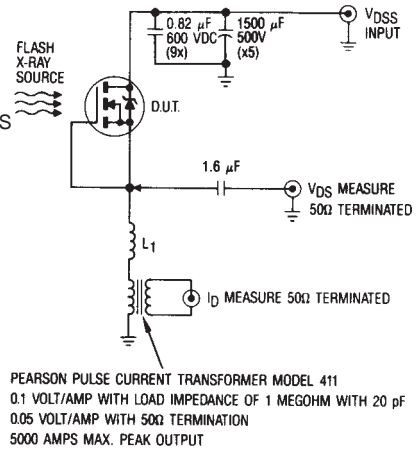

Fig 9. High Dose Rate (Gamma Dot) Test Circuit

Note: Bias Conditions during radiation:  $V_{GS} = 12 \text{ Vdc}$ ,  $V_{DS} = 0 \text{ Vdc}$

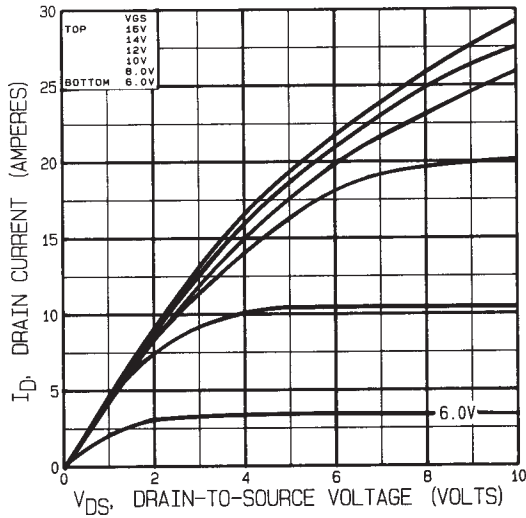

Fig 10. Typical Output Characteristics Pre-Irradiation

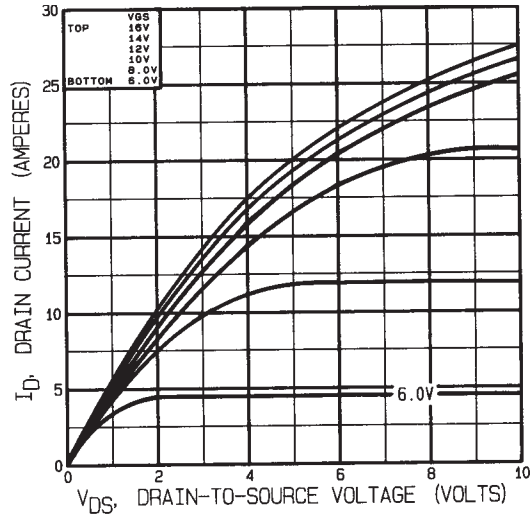

Fig 11. Typical Output Characteristics Post-Irradiation 100K Rads (Si)

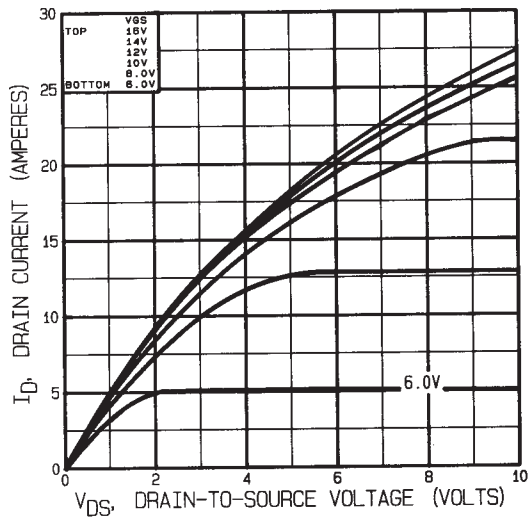

Fig 12. Typical Output Characteristics Post-Irradiation 300K Rads (Si)

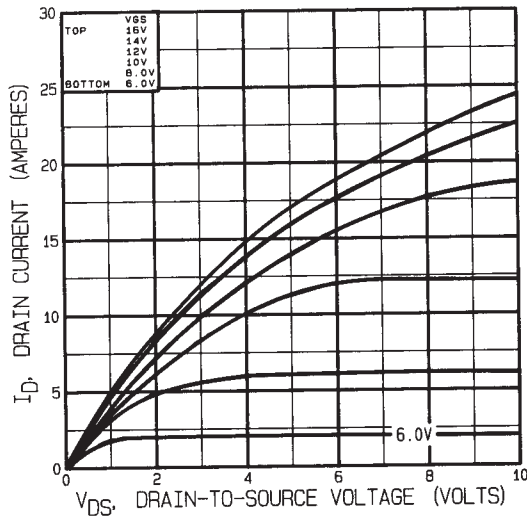
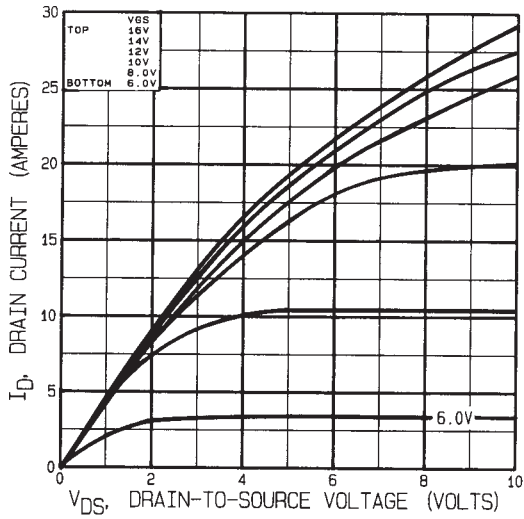

Fig 13. Typical Output Characteristics Post-Irradiation 1 Mega Rads (Si)

## Radiation Characteristics

IRHE7230, JANSR2N7262U

Note: Bias Conditions during radiation:  $V_{GS} = 0$  Vdc,  $V_{DS} = 160$  Vdc



**Fig 14.** Typical Output Characteristics  
Pre-Irradiation

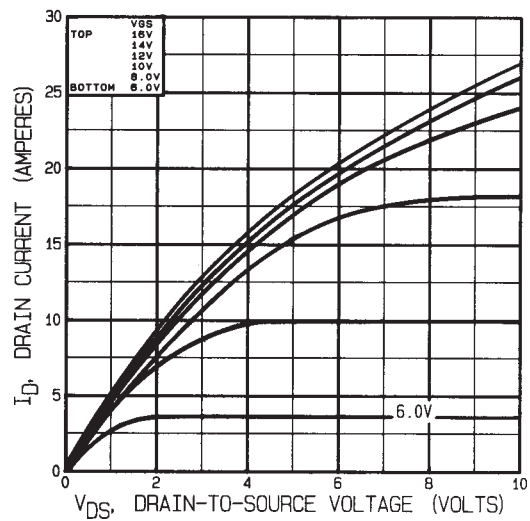

**Fig 15.** Typical Output Characteristics  
Post-Irradiation 100K Rads (Si)

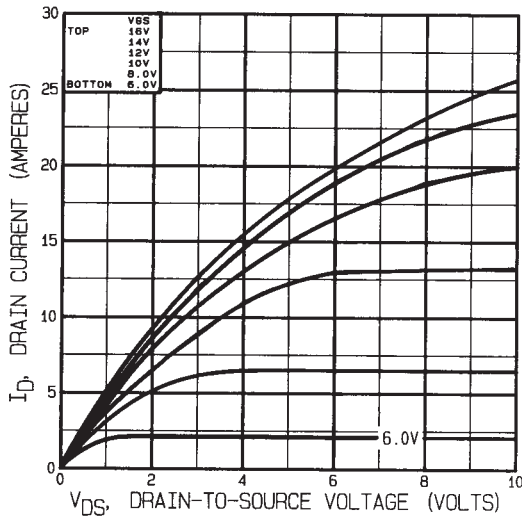

**Fig 16.** Typical Output Characteristics  
Post-Irradiation 300K Rads (Si)

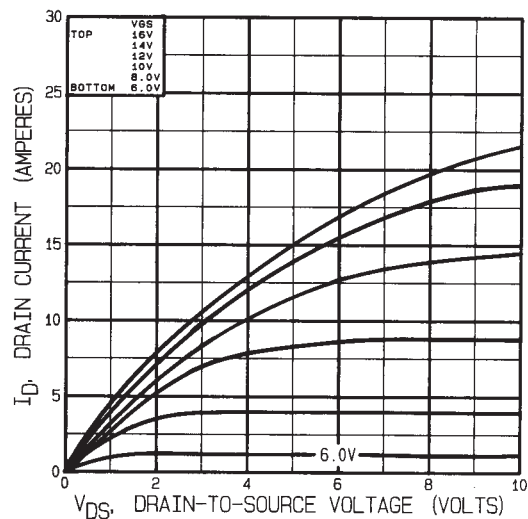

**Fig 17.** Typical Output Characteristics  
Post-Irradiation 1 Mega Rads (Si)

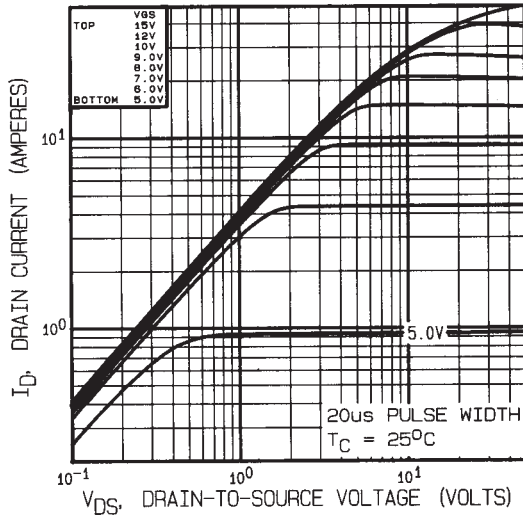

Fig 18. Typical Output Characteristics

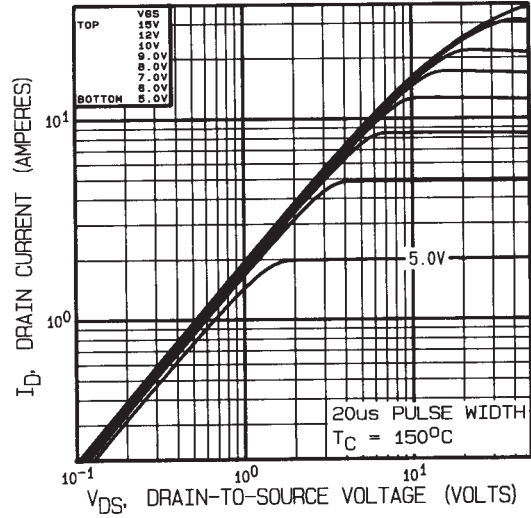

Fig 19. Typical Output Characteristics

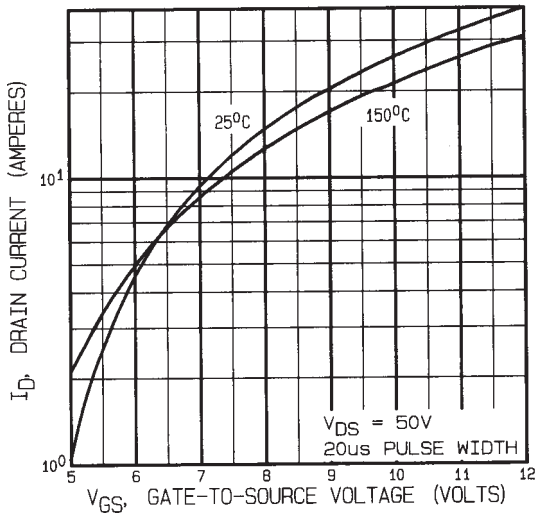

Fig 20. Typical Transfer Characteristics

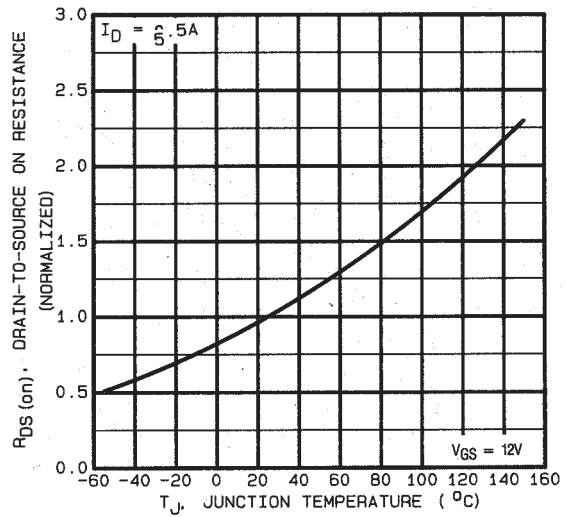
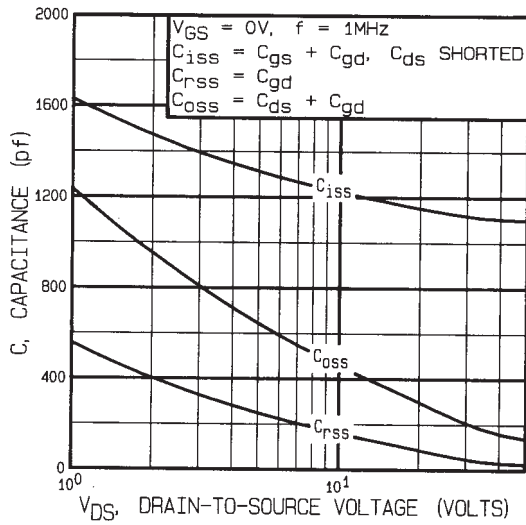
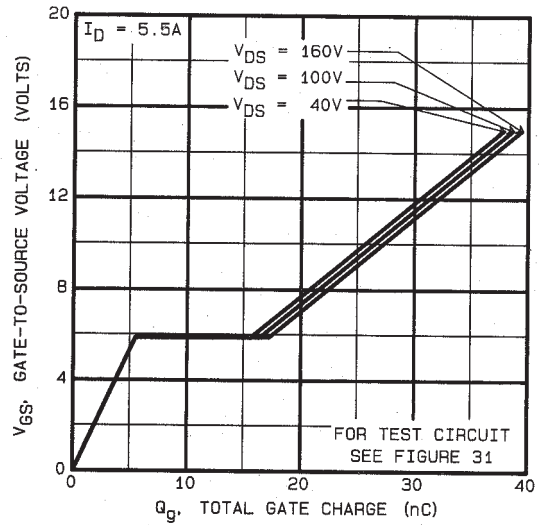

Fig 21. Normalized On-Resistance Vs. Temperature

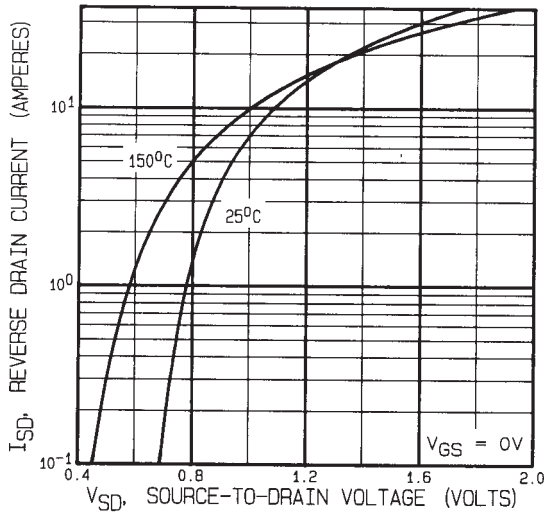



**Fig 22.** Typical Capacitance Vs. Drain-to-Source Voltage



**Fig 23.** Typical Gate Charge Vs. Gate-to-Source Voltage



**Fig 24.** Typical Source-Drain Diode Forward Voltage

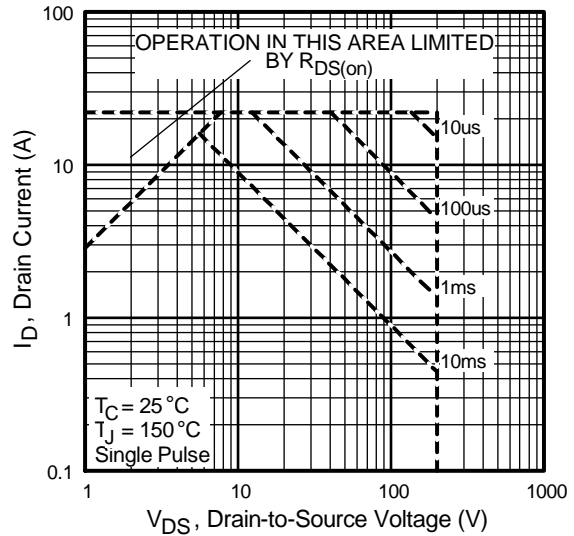

**Fig 25.** Maximum Safe Operating Area

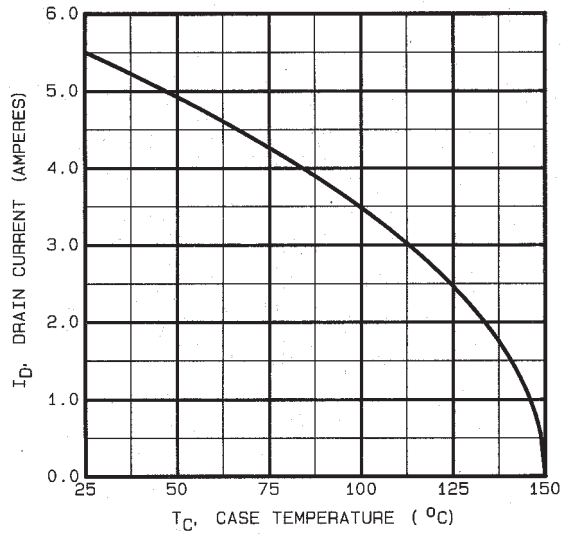

Fig 26. Maximum Drain Current Vs. Case Temperature

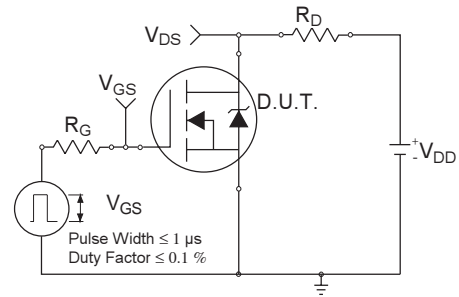

Fig 27a. Switching Time Test Circuit

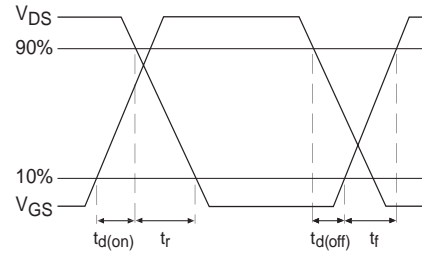

Fig 27b. Switching Time Waveforms

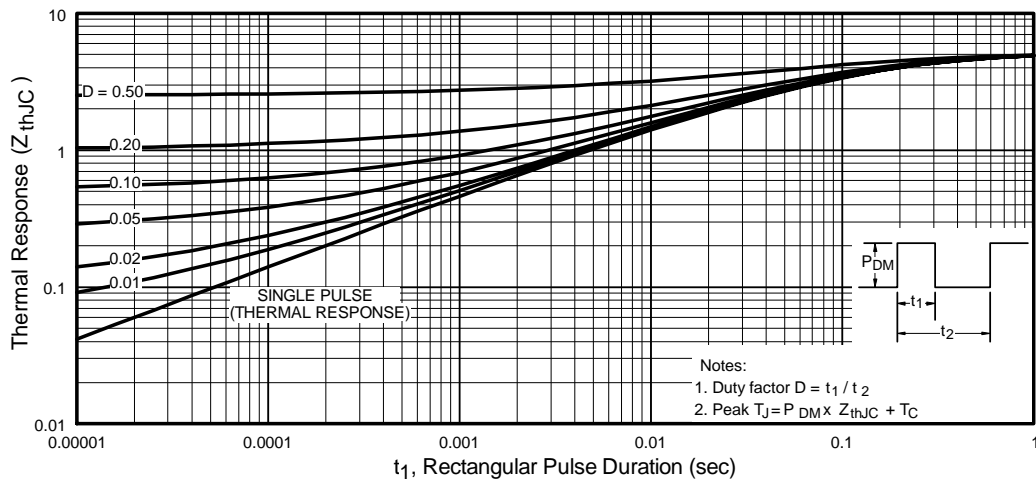

Fig 28. Maximum Effective Transient Thermal Impedance, Junction-to-Case

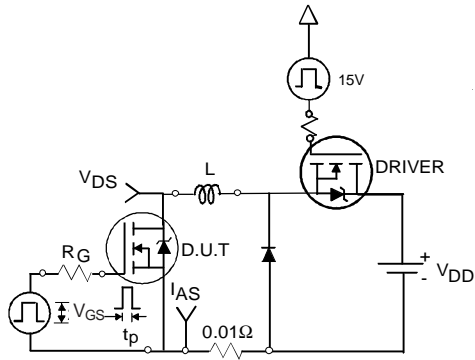

Fig 29a. Unclamped Inductive Test Circuit

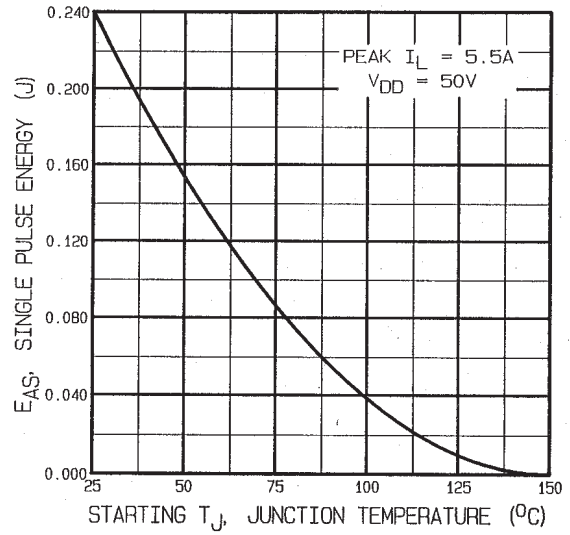

Fig 29c. Maximum Avalanche Energy Vs. Drain Current

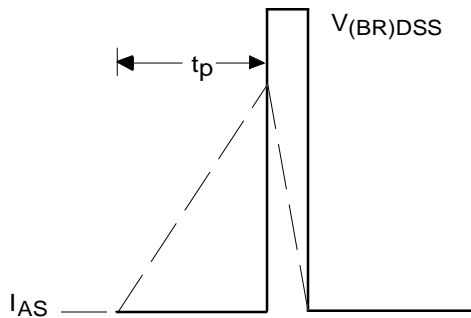

Fig 29b. Unclamped Inductive Waveforms

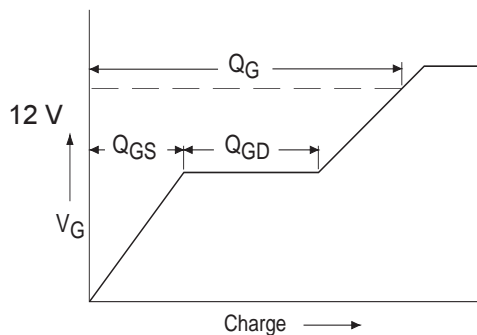

Fig 30a. Basic Gate Charge Waveform

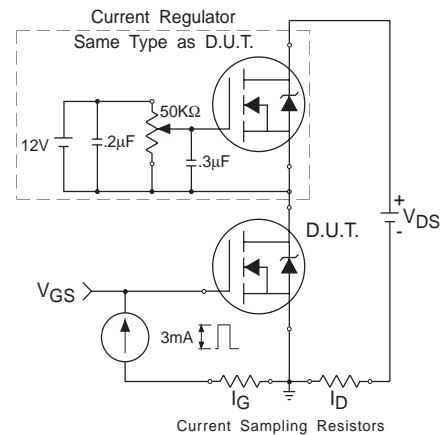
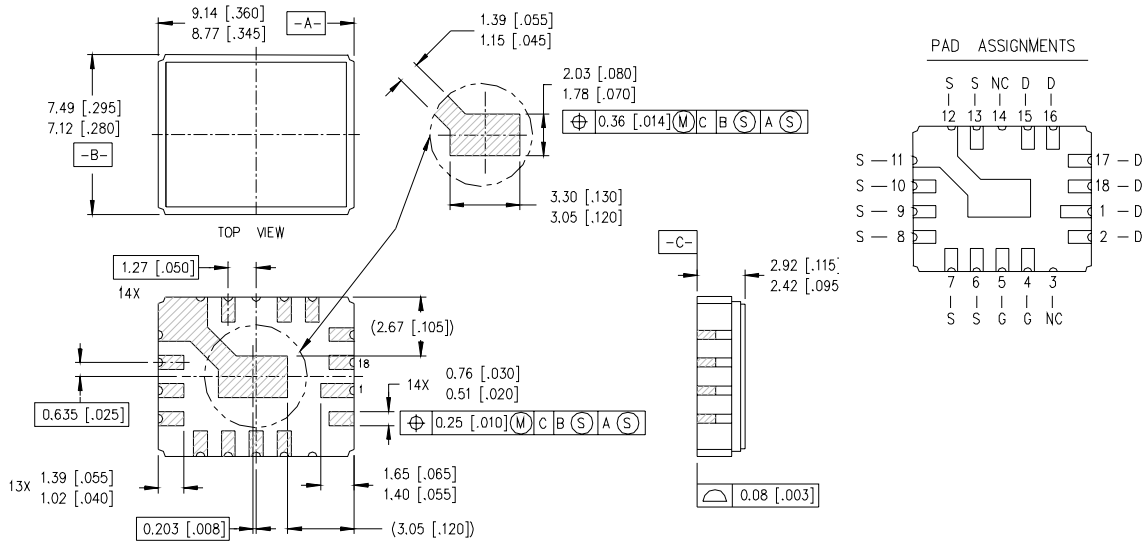

Fig 30b. Gate Charge Test Circuit

**Foot Notes:**

- ① Repetitive Rating; Pulse width limited by maximum junction temperature.
- ②  $V_{DD} = 25V$ , starting  $T_J = 25^\circ C$ ,  $L = 15.9mH$   
Peak  $I_L = 5.5A$ ,  $V_{GS} = 12V$
- ③  $I_{SD} \leq 5.5A$ ,  $di/dt \leq 120A/\mu s$ ,  
 $V_{DD} \leq 200V$ ,  $T_J \leq 150^\circ C$
- ④ Pulse width  $\leq 300 \mu s$ ; Duty Cycle  $\leq 2\%$
- ⑤ **Total Dose Irradiation with  $V_{GS}$  Bias.**  
12 volt  $V_{GS}$  applied and  $V_{DS} = 0$  during irradiation per MIL-STD-750, method 1019, condition A.
- ⑥ **Total Dose Irradiation with  $V_{DS}$  Bias.**  
160 volt  $V_{DS}$  applied and  $V_{GS} = 0$  during irradiation per MIL-STD-750, method 1019, condition A.

**Case Outline and Dimensions — LCC-18**



**NOTES:**

- 1. DIMENSIONING & TOLERANCING PER ANSI Y14.5M-1982.
- 2. CONTROLLING DIMENSION: INCH.
- 3. DIMENSIONS ARE SHOWN IN MILLIMETERS [INCHES].

**LEGEND**

- G = GATE
- D = DRAIN
- S = SOURCE
- NC = NO CONNECTION

International  
**IR** Rectifier

**IR WORLD HEADQUARTERS:** 233 Kansas St., El Segundo, California 90245, USA Tel: (310) 252-7105

**IR LEOMINSTER :** 205 Crawford St., Leominster, Massachusetts 01453, USA Tel: (978) 534-5776

TAC Fax: (310) 252-7903

Visit us at [www.irf.com](http://www.irf.com) for sales contact information.

Data and specifications subject to change without notice. 05/2006