



Thin-Film Cascadable Amplifier 5 to 1000 MHz

Technical Data

UTO/UTC 1002 Series

Features

- **Frequency Range: 5 to 1000 MHz**
- **Medium Gain: 14.5 dB (Typ)**
- **Medium Output Power: +8.5 dBm (Typ)**

Applications

- **IF/RF Amplification**

Description

The 1002 Series is a thin-film bipolar RF amplifier that uses resistive feedback and active bias to provide a stable, reliable gain stage. Inductively-coupled input and output circuits provide good VSWR under all conditions. Input and output blocking capacitors couple the RF through the amplifier. The 1002 Series amplifiers are available in either the TO-8 hermetic case or connected TC-1A package.

Pin Configuration UTO—TO-8U

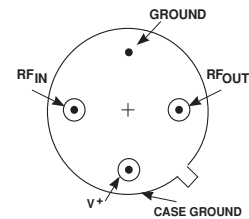

UTC—TC-1A

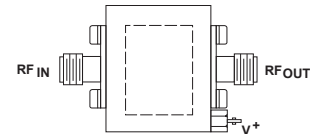

Schematic

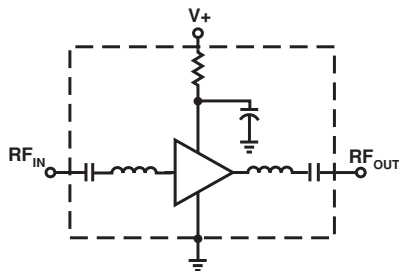

Maximum Ratings

Parameter	Maximum
DC Voltage	+17 Volts
Continuous RF Input Power	+13 dBm
Operating Case Temperature	-55 to +125°C
Storage Temperature	-62 to +150°C
“R” Series Burn-In Temperature	+125°C

Thermal Characteristics¹

θ_{JC}	90°C/W
Active Transistor Power Dissipation	120 mW
Junction Temperature Above Case Temperature	11°C
MTBF (MIL-HDBK-217E, A_{UF} @ 90°C)	1,246,000 Hrs.

Weight: (typical) UTO—2.1 grams; UTC—21.5 grams

Electrical Specifications

(Measured in 50 Ω system @ +15 VDC nominal unless otherwise noted)

Symbol	Characteristic	Typical $T_C = 25^\circ\text{C}$	Guaranteed Specifications		Unit
			$T_C = 0 \text{ to } 50^\circ\text{C}$	$T_C = -55 \text{ to } +85^\circ\text{C}$	
BW	Frequency Range	5-1000	5-1000	5-1000	MHz
GP	Small Signal Gain (Min.)	14.5	14.0	13.5	dB
—	Gain Flatness (Max.)	± 0.5	± 1.0	± 1.0	dB
NF	Noise Figure (Max.)	3.0	4.0	4.5	dB
P _{1dB}	Power Output @ +1 dB Comp. (Min.)	+8.5	+7.0	+7.0	dBm
—	Input VSWR (Max.)	<1.5:1	2.0:1	2.0:1	—
—	Output VSWR (Max.)	<1.5:1	2.0:1	2.0:1	—
IP ₃	Two Tone 3rd Order Intercept Point	+21.0	—	—	dBm
IP ₂	Two Tone 2nd Order Intercept Point	+30.0	—	—	dBm
HP ₂	One Tone 2nd Harmonic Intercept Point	+36.0	—	—	dBm
I _D	DC Current	23	—	—	mA

Typical Performance Over Temperature (@ +15 VDC unless otherwise noted)

Key: +25°C ———
+85°C - - - -
-55°C ———

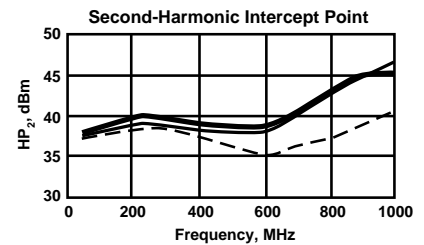
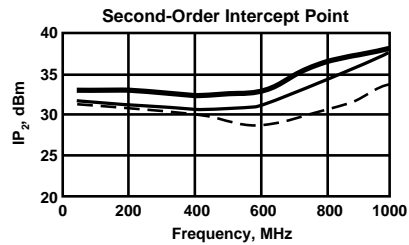
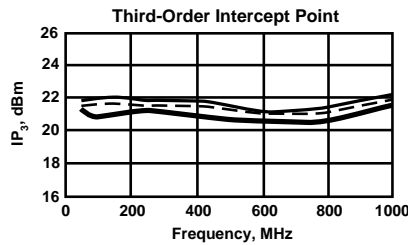
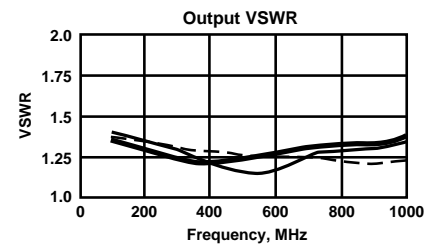
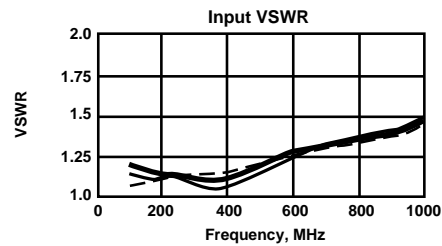
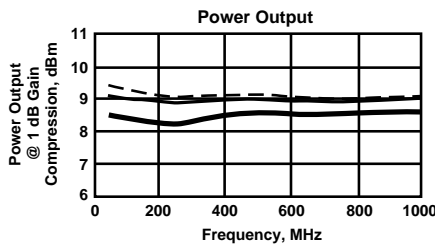
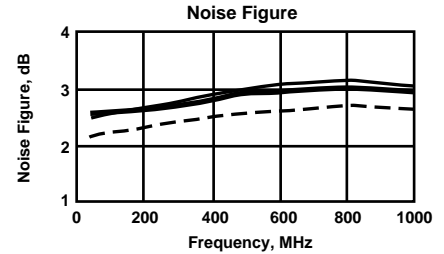
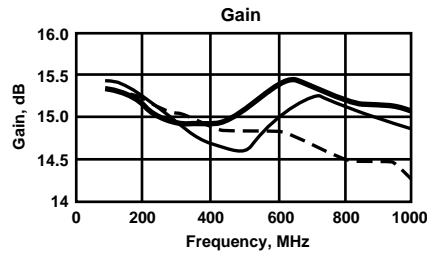

Automatic Network Analyzer Measurements (Typical production unit @ +25°C ambient)**Numerical Readings****Bias = 15.00 Volts**

FREQUENCY MHz	VSWR IN	GAIN dB	PHASE DEGREES	PHASE DEV	GROUP DELAY ns	VSWR OUT	ISOLATION dB
100.0	1.36	14.85	156.93	-.77	—	1.14	20.63
150.0	1.37	14.72	145.59	-.92	.63	1.13	20.69
200.0	1.40	14.66	134.27	-1.06	.63	1.14	20.69
250.0	1.43	14.67	122.99	-1.16	.62	1.15	20.70
300.0	1.45	14.70	111.95	-1.02	.60	1.16	20.75
350.0	1.49	14.68	101.24	-.54	.59	1.18	20.76
400.0	1.54	14.65	90.56	-.04	.59	1.20	20.76
450.0	1.57	14.56	80.05	.63	.59	1.23	20.81
500.0	1.60	14.53	69.29	1.05	.60	1.25	20.81
550.0	1.63	14.49	58.39	1.34	.60	1.28	20.84
600.0	1.65	14.44	47.72	1.86	.60	1.32	20.83
650.0	1.67	14.43	36.75	2.08	.61	1.37	20.82
700.0	1.66	14.40	25.68	2.20	.63	1.40	20.79
750.0	1.63	14.40	14.22	1.92	.64	1.45	20.73
800.0	1.59	14.42	2.58	1.46	.65	1.52	20.68
850.0	1.52	14.49	-9.35	.71	.68	1.57	20.60
900.0	1.43	14.52	-21.84	-.58	.71	1.62	20.51
950.0	1.31	14.62	-34.95	-2.40	.74	1.68	20.47
1000.0	1.18	14.69	-48.37	-4.74	.77	1.72	20.40
1050.0	1.08	14.73	-62.42	—	.81	1.73	20.41
1100.0	1.24	14.70	-77.41	—	.86	1.71	20.47
1150.0	1.54	14.50	-93.33	—	.93	1.65	20.66
1200.0	2.00	14.17	-110.74	—	.97	1.55	21.05
1250.0	2.70	13.68	-129.23	—	.95	1.41	21.75

LINEARIZATION RANGE: 100.0 to 500.0 MHz

S-Parameters**Bias = 15.00 Volts**

FREQUENCY MHz	S ₁₁		S ₂₁		S ₁₂		S ₂₂	
	Mag	Ang	dB	Ang	dB	Ang	Mag	Ang
100.00	.048	.8	14.48	156.3	-20.00	-6.8	.031	174.6
200.00	.070	-10.2	14.38	137.1	-20.00	-15.3	.034	167.6
300.00	.102	-25.1	14.47	115.0	-19.91	-24.5	.042	163.5
400.00	.136	-41.6	14.45	93.1	-20.00	-33.2	.056	163.0
500.00	.175	-60.1	14.48	72.2	-19.74	-43.8	.081	159.5
600.00	.206	-79.0	14.57	50.0	-19.66	-53.1	.114	154.0
700.00	.224	-96.4	14.82	27.1	-19.57	-63.2	.161	140.2
800.00	.221	-117.4	14.81	5.6	-19.49	-75.5	.215	125.0
900.00	.195	-143.6	15.15	-20.6	-19.17	-89.7	.270	105.1
1000.00	.108	168.1	15.55	-47.4	-18.79	-105.0	.319	79.9
1100.00	.158	54.6	15.65	-78.0	-18.71	-127.1	.351	44.8
1200.00	.405	.8	15.07	-113.9	-19.66	-153.7	.324	-2.1
1300.00	.658	-36.6	13.45	-152.0	-21.83	176.4	.291	-65.7
1400.00	.818	-64.4	10.62	175.5	-25.51	149.7	.314	-125.3
1500.00	.885	-86.9	7.30	148.4	-30.46	126.0	.383	-170.0

Product Options

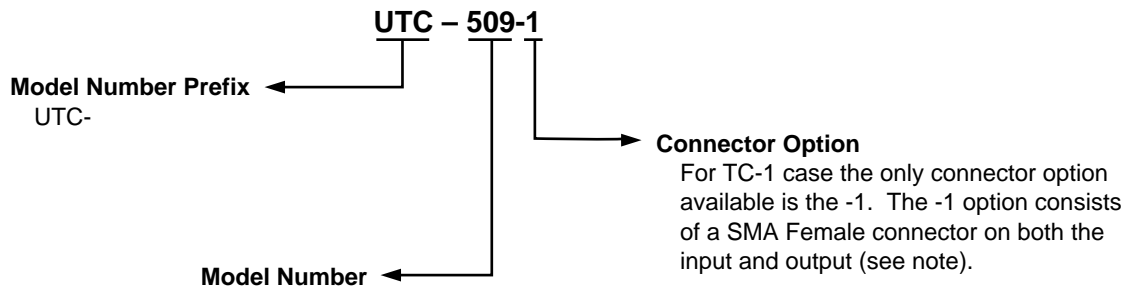
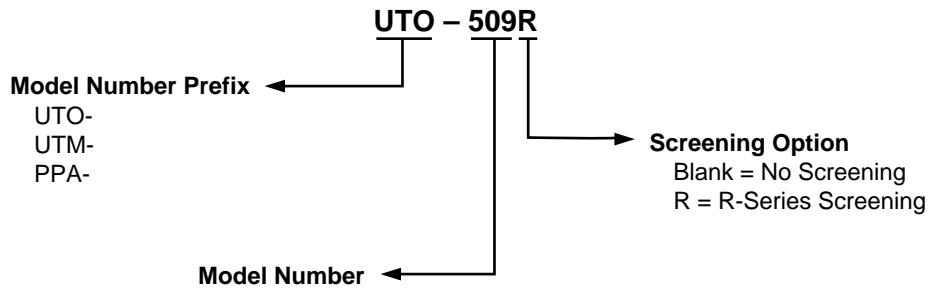

Note: R-Series screening is not available in the TC-1 case as the case is non-hermetic.

**Case Drawings
TO-8U**

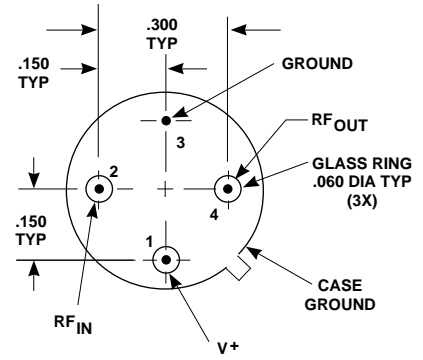
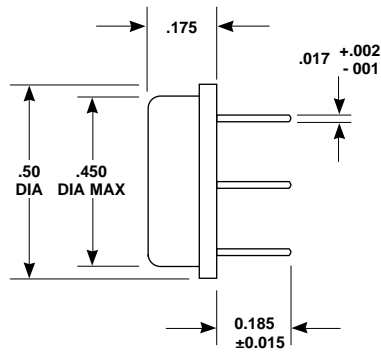
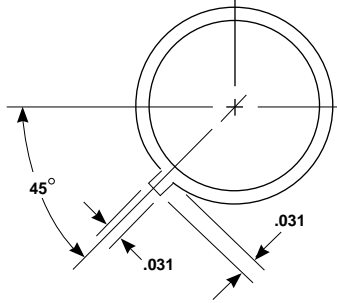

APPROXIMATE WEIGHT 2.1 GRAMS

- NOTES (UNLESS OTHERWISE SPECIFIED):
 1. DIMENSIONS ARE SPECIFIED IN INCHES
 2. TOLERANCES: xx ± .02
 xxx ± .010

Case Drawings TC-1

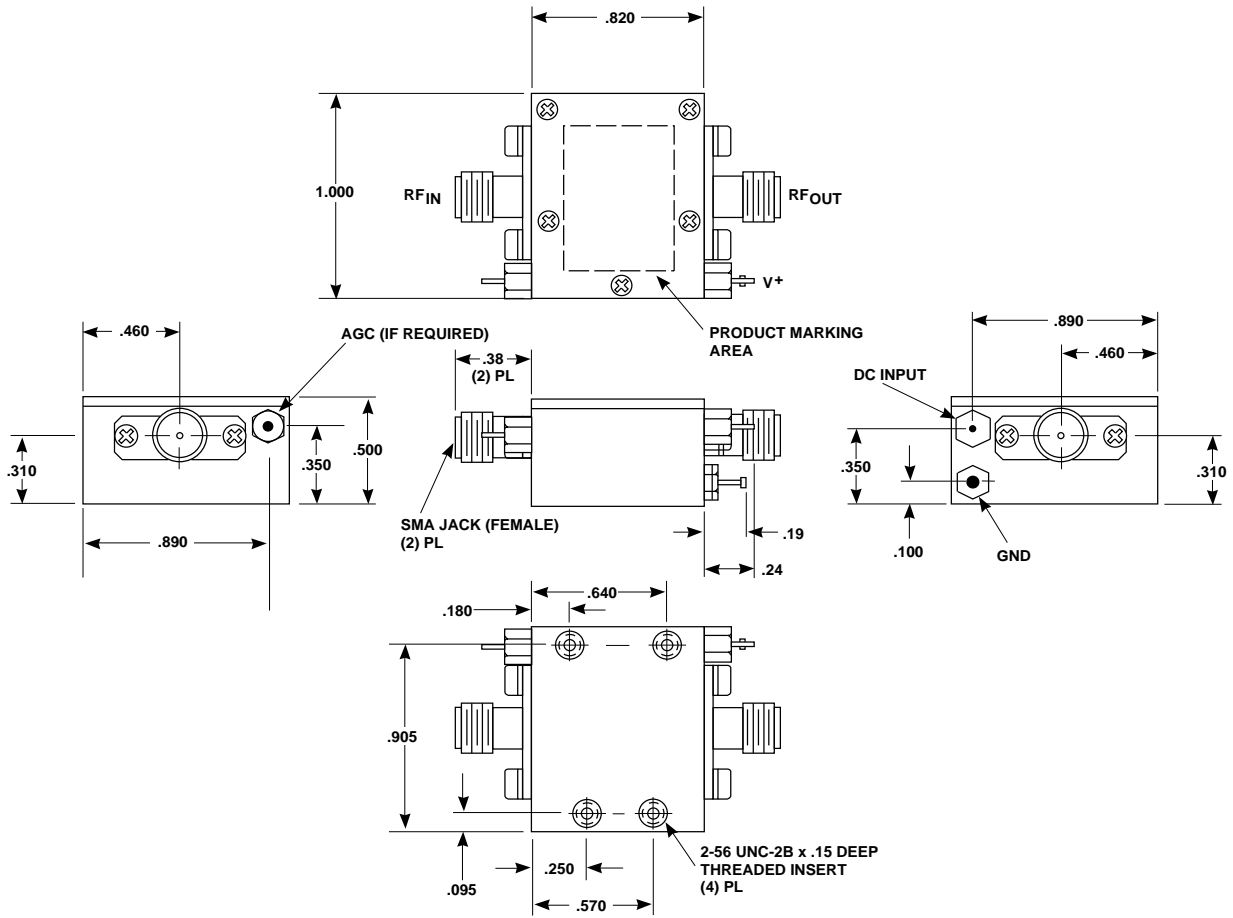

TYPICAL WEIGHT WITH CONNECTORS = 21.5 GRAMS

NOTES: 1. THE TC-1 CASE IS A NON-HERMETIC CASE.
2. THE ONLY CONNECTOR OPTION AVAILABLE FOR THE TC-1 CASE IS THE -1, SMA FEMALE CONNECTORS AT BOTH INPUT AND OUTPUT PORTS.

NOTES (UNLESS OTHERWISE SPECIFIED):
1. DIMENSIONS ARE SPECIFIED IN INCHES
2. TOLERANCES: xx ± .02
xxx ± .010

Contact Teledyne Microwave Solutions:
650-691-9800
650-962-6845 fax

Check for updates:
www.teledynemicrowave.com