

High Voltage Fast Switching PNP Power Transistor

3CD14001

FEATURES

- $P_C=500\text{mW}$ (Mounted on ceramic substrate).
- High speed switching.
- Small flat package.



Lead-free

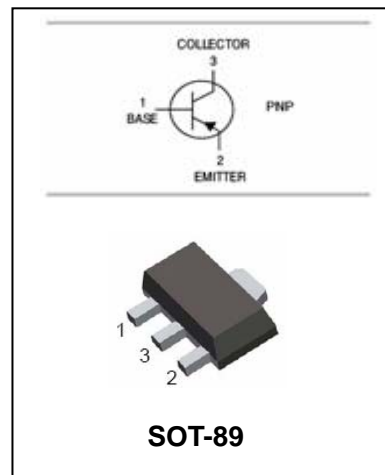

APPLICATIONS

- High voltage switch mode application.

ORDERING INFORMATION

Type No.	Marking	Package Code
3CD14001	14001	SOT-89

MAXIMUM RATING @ $T_a=25^\circ\text{C}$ unless otherwise specified

Symbol	Parameter	Value	Units
V_{CBO}	Collector-Base Voltage	-400	V
V_{CEO}	Collector-Emitter Voltage	-400	V
V_{EBO}	Emitter-Base Voltage	-7	V
I_C	Collector Current -Continuous	-0.2	A
P_C	Collector Dissipation	500	mW
T_j, T_{stg}	Junction and Storage Temperature	-55 to +150	$^\circ\text{C}$



High Voltage Fast Switching PNP Power Transistor

3CD14001

ELECTRICAL CHARACTERISTICS @ Ta=25°C unless otherwise specified

Parameter	Symbol	Test conditions	MIN	TYP	MAX	UNIT
Collector-base breakdown voltage	$V_{(BR)CBO}$	$I_C = -100\mu A, I_E = 0$	-400			V
Collector-emitter breakdown voltage	$V_{(BR)CEO}$	$I_C = -1mA, I_B = 0$	-400			V
Emitter-base breakdown voltage	$V_{(BR)EBO}$	$I_E = -100\mu A, I_C = 0$	-7			V
Collector cut-off current	I_{CBO}	$V_{CB} = -400V, I_E = 0$			-100	μA
Collector cut-off current	I_{CEO}	$V_{CE} = -400V, I_B = 0$			-200	μA
Emitter cut-off current	I_{EBO}	$V_{EB} = -7V, I_C = 0$			-100	μA
DC current gain	h_{FE}	$V_{CE} = -20V, I_C = -20mA$	10		40	
		$V_{CE} = -10V, I_C = -0.25A$	5			
Collector-emitter saturation voltage	$V_{CE(sat)}$	$I_C = -50mA, I_B = -10mA$			-0.5	V
Base-emitter saturation voltage	$V_{BE(sat)}$	$I_C = -50mA, I_B = -10mA$			-1.2	V
Transition frequency	f_T	$V_{CE} = -20V, I_C = -20mA, f = 1MHz$	8			MHz
Fall time	t_f	$I_C = 50mA, I_{B1} = I_{B2} = 5mA, V_{CC} = 45V$			0.3	μS
Storage time	t_s				1.5	μS

CLASSIFICATION OF $h_{FE(1)}$

Range	10-15	15-20	20-25	25-30	30-35	35-40

TYPICAL CHARACTERISTICS @ Ta=25°C unless otherwise specified

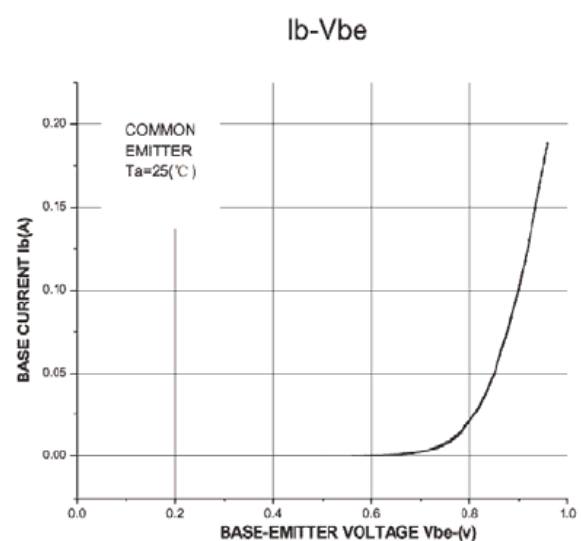
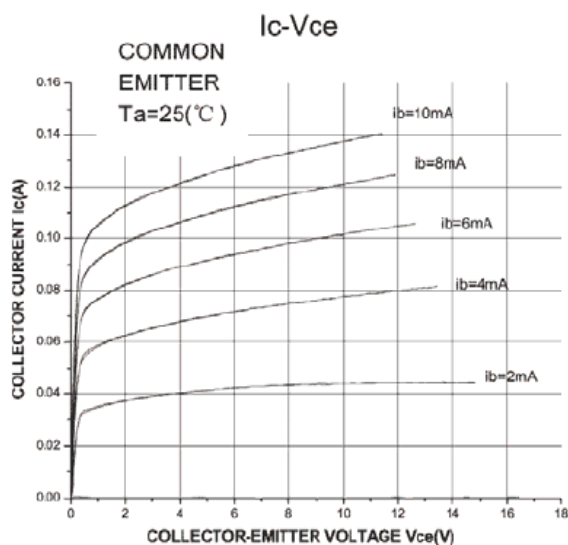



High Voltage Fast Switching PNP Power Transistor

3CD14001

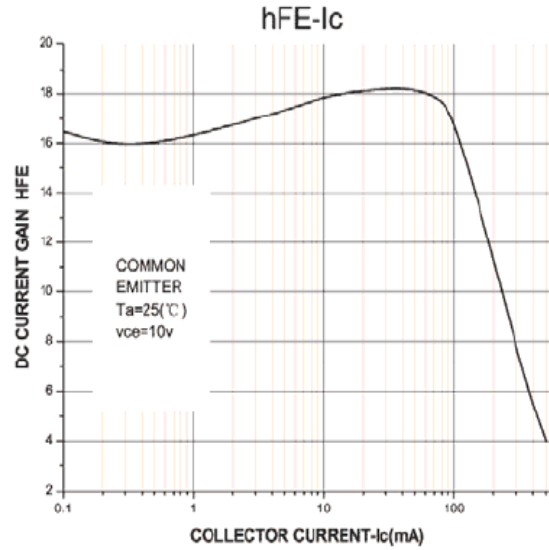
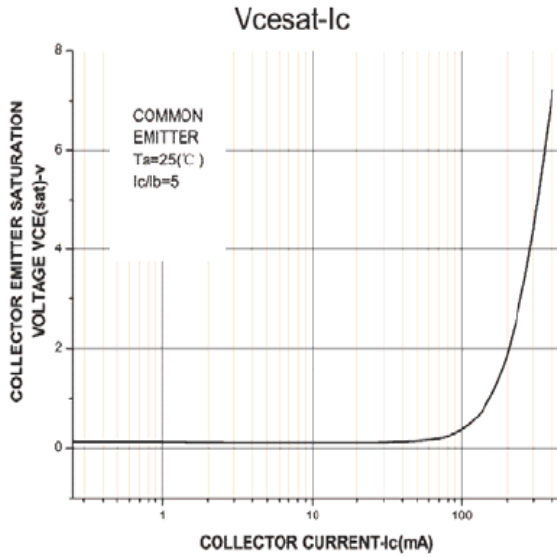

High Voltage Fast Switching PNP Power Transistor

3CD14001

PACKAGE OUTLINE

Plastic surface mounted package

SOT-89

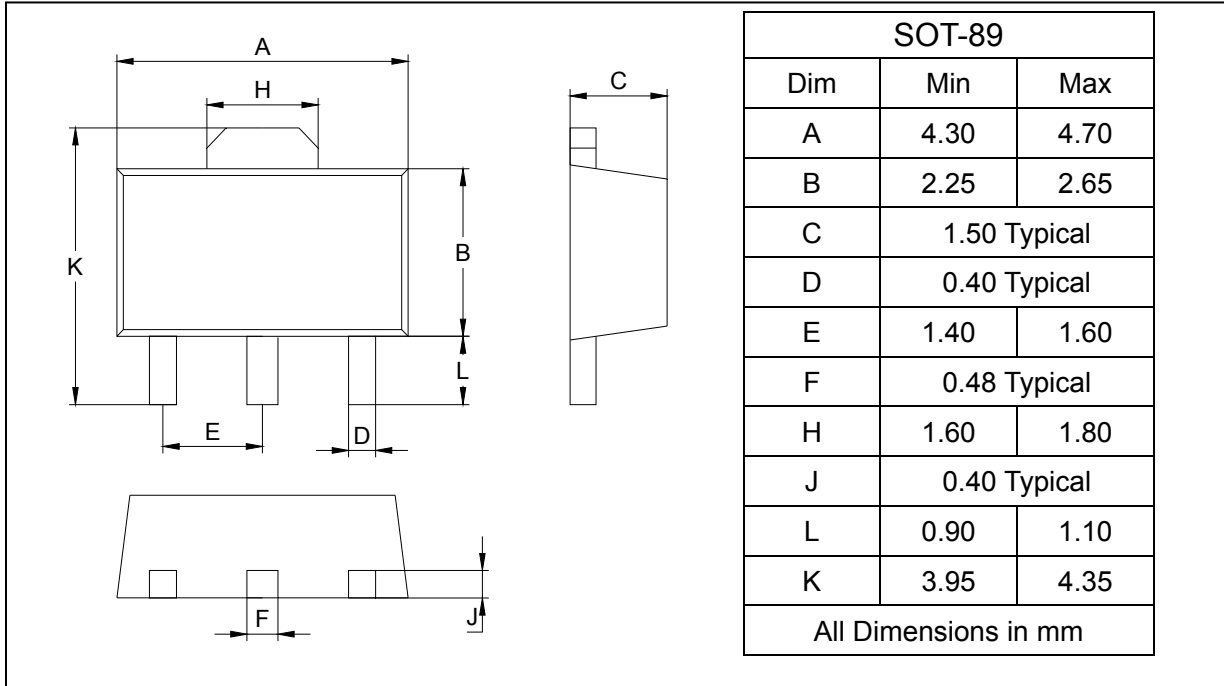

SOLDERING FOOTPRINT

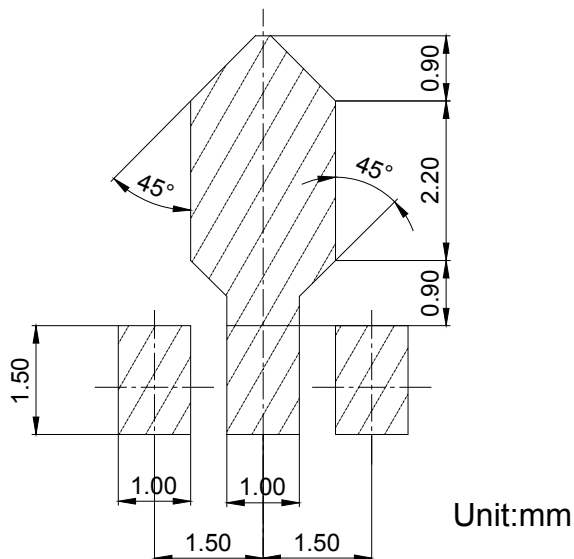

PACKAGE INFORMATION

Device	Package	Shipping
3CD14001	SOT-89	1000/Tape&Reel