

## ST repetitive voltage suppressor

Datasheet - production data

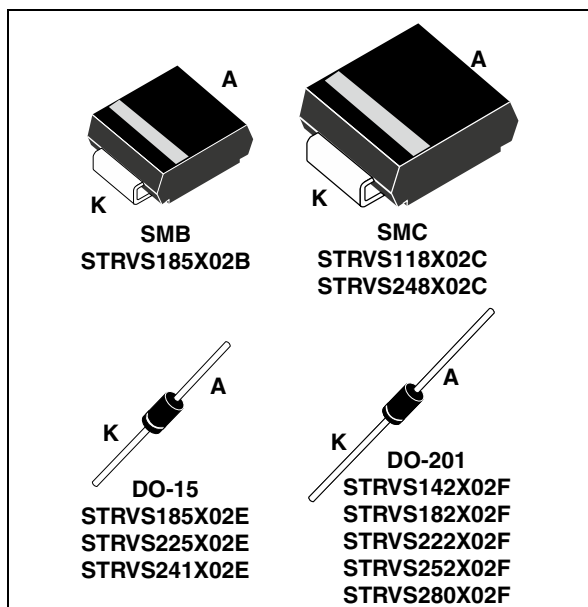

### Applications

- MOSFET protection
- IGBT protection
- Auxiliary power supply

### Description

The STRVSX series is a TVS family created to provide simple and effective solutions for designers working on circuits that require protection from repetitive overvoltage.

The STRVSX series is highly reliable and suits applications where the surge frequency makes the protected device temperature increase, for example, MOSFET protection in fly back configuration.

Additional support for designers using these devices is available in the STMicroelectronics application note AN4209: "Design methodology for repetitive voltage suppressors (RVS) in repetitive mode: STRVS".

### Features

- Clamping voltage characteristics defined at 25 °C, 85 °C and 125 °C
- Stand-off voltage range: from 85 V to 188 V
- Low leakage current: 0.2  $\mu$ A at 25 °C
- Maximum operating junction temperatures:
  - SMB and SMC: 150 °C
  - DO-15 and DO-201: 175 °C

### Complies with the following standards:

- IEC 61000-4-2 level 4
  - $\pm$ 15 kV (air discharge)
  - $\pm$ 8 kV (contact discharge)
- MIL-STD-883, method 3015, class 3B:
  - 25 kV HBM (human body model)
- MIL-STD-750, method 2026 solderability
- EIA STD RS-481 and IEC 60286-3 packing (surface mount packages)

Table 1. Device summary

Order codes	Clamping voltage $I_{PP} = 2$ A (125 °C)	Package
STRVS118X02C	118 V	SMC
STRVS142X02F	142 V	DO-201
STRVS182X02F	182 V	DO-201
STRVS185X02B	185 V	SMB
STRVS185X02E	185 V	DO-15
STRVS222X02F	222 V	DO-201
STRVS225X02E	225 V	DO-15
STRVS241X02E	241 V	DO-15
STRVS248X02C	248 V	SMC
STRVS252X02F	252 V	DO-201
STRVS280X02F	280 V	DO-201

# 1 Characteristics

**Table 2. Absolute maximum ratings ( $T_{amb} = 25\text{ }^{\circ}\text{C}$ )**

Symbol	Parameter	Value	Unit
$T_j$	Operating junction temperature range (SMB and SMC)	-55 to 150	$^{\circ}\text{C}$
	Operating junction temperature range (DO-15 and DO-201)	-55 to 175	$^{\circ}\text{C}$
$T_{stg}$	Storage temperature range (SMB and SMC)	-65 to 150	$^{\circ}\text{C}$
	Storage temperature range (DO-15 and DO-201)	-65 to 175	$^{\circ}\text{C}$
$T_L$	Maximum lead temperature for soldering during 10 s (SMB and SMC)	260	$^{\circ}\text{C}$
	Maximum lead temperature for soldering during 10 s at 5 mm from case (DO-15 and DO-201)	260	$^{\circ}\text{C}$

**Table 3. Thermal resistances**

Symbol	Parameter	Value	Unit	
$R_{th(j-l)}$	Junction to leads	SMB	13	$^{\circ}\text{C/W}$
		SMC	12	
		DO-15	35	
		DO-201	23	
$R_{th(j-a)}$	Junction to ambient	SMB <sup>(1)</sup>	185	
		SMC <sup>(1)</sup>	150	
		DO-15	105	
		DO-201	100	

1. On printed circuit with recommended pad layout

**Figure 1. Electrical characteristics - definitions**

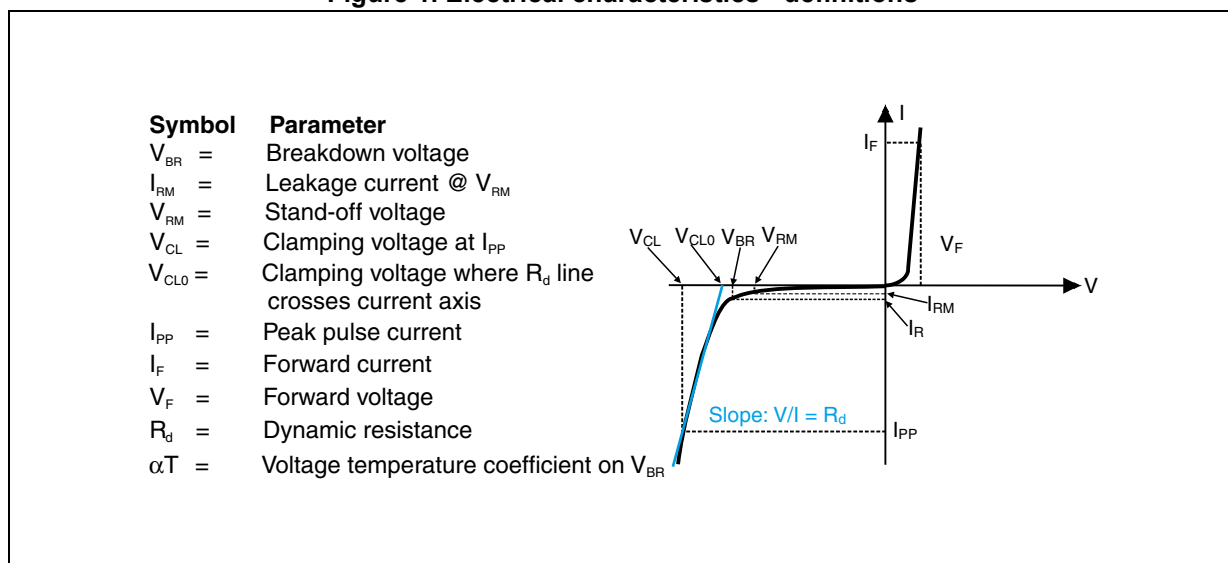

Table 4. Electrical characteristics - values

Order code	I <sub>RM</sub> max @ V <sub>RM</sub> (25 °C)		V <sub>BR</sub> @ I <sub>R</sub> <sup>(1)</sup> (25 °C)		Values @ 125 °C (typ.)				αT	
			Min.	Max.	I <sub>PP</sub>	V <sub>CL</sub> @ I <sub>PP</sub>	V <sub>CL0</sub>	R <sub>d</sub> <sup>(2)</sup>	Max.	
	μA	V	V		mA	A	V	V	Ω	10 <sup>-4</sup> /°C
STRVS118X02C	0.2	85	95	105	1	2	118	116	1.0	10.6
STRVS142X02F	1	102	114	126	1	2	142	140	1.0	10.7
STRVS182X02F	1	128	143	158	1	2	182	177	2.5	10.8
STRVS185X02B/E	0.2	128	143	158	1	2	185	178	2.5	10.8
STRVS222X02F	1	154	171	189	1	2	222	213	4.5	10.8
STRVS225X02E	0.5	154	171	189	1	2	225	214	5.5	10.8
STRVS241X02E	0.5	171	190	210	1	2	241	234	3.5	10.8
STRVS248X02C	0.5	171	190	210	1	2	248	238	5.0	10.8
STRVS252X02F	1	171	190	210	1	2	252	239	6.5	10.8
STRVS280X02F	1	188	209	231	1	2	280	263	8.5	10.8

1. To calculate V<sub>BR</sub> at a given junction temperature, use the following formula:

$$V_{BR} @ T_j = V_{BR} @ 25\text{ °C} \times (1 + \alpha T \times (T_j - 25))$$

$$2. R_d = (V_{CL} - V_{CL0}) / I_{PP}$$

Figure 2. Clamping voltage versus peak pulse current - STRVS118X02C (typical values)

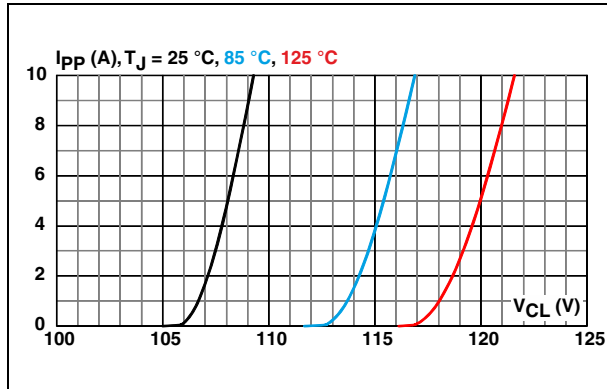

Figure 3. Clamping voltage versus peak pulse current - STRVS142X02F (typical values)

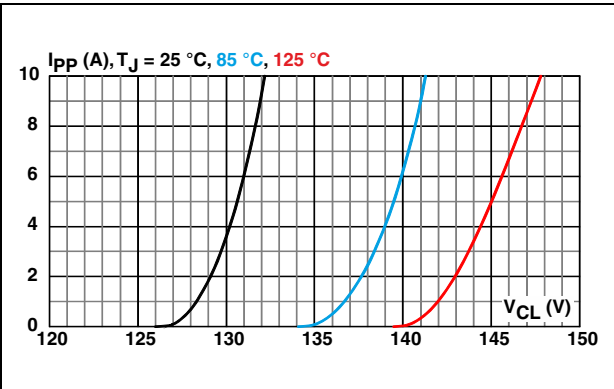

Figure 4. Clamping voltage versus peak pulse current - STRVS182X02F (typical values)

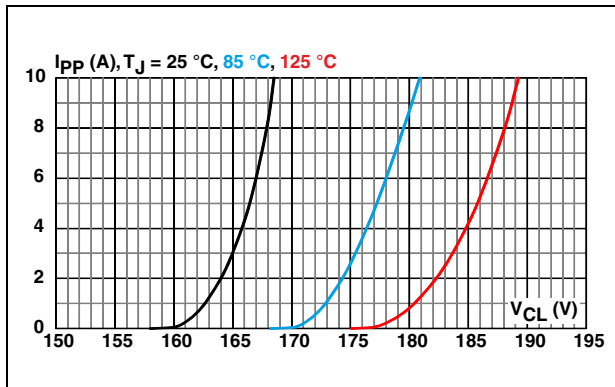

Figure 5. Clamping voltage versus peak pulse current - STRVS185X02B/E (typical values)

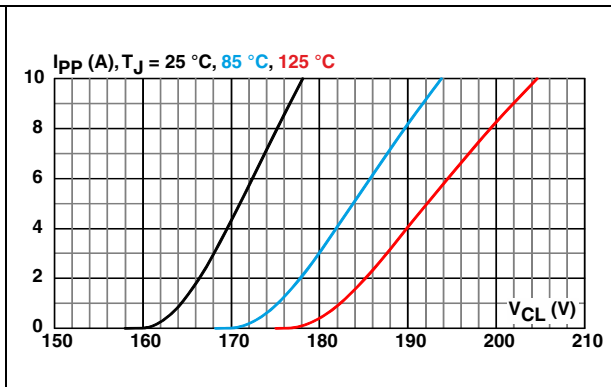

Figure 6. Clamping voltage versus peak pulse current - STRVS222X02F (typical values)

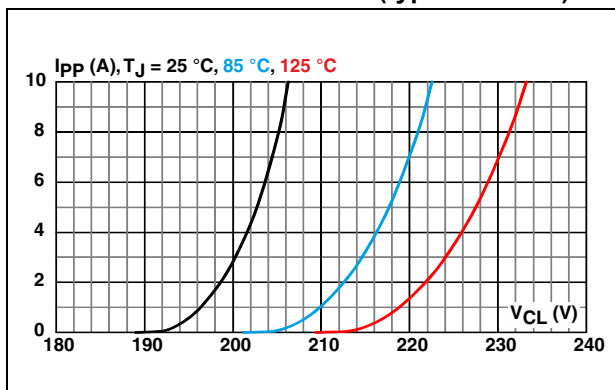

Figure 7. Clamping voltage versus peak pulse current - STRVS225X02E (typical values)

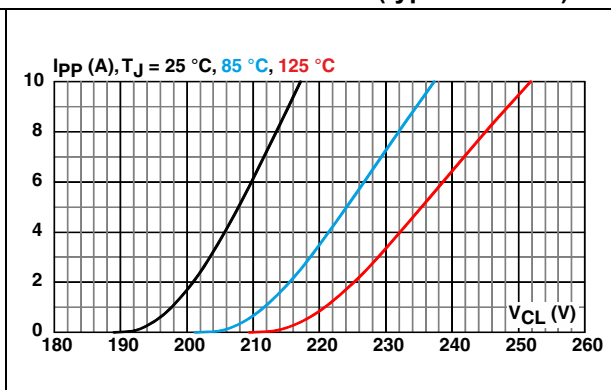

Figure 8. Clamping voltage versus peak pulse current - STRVS241X02E (typical values)

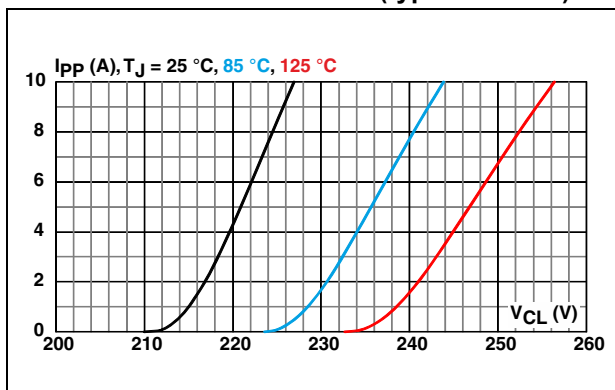

Figure 9. Clamping voltage versus peak pulse current - STRVS248X02C (typical values)

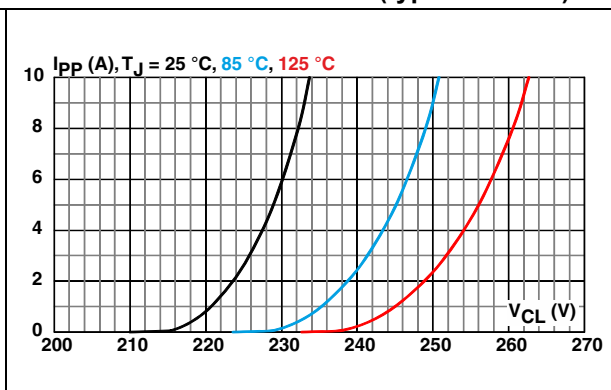

Figure 10. Clamping voltage versus peak pulse current - STRVS252X02F

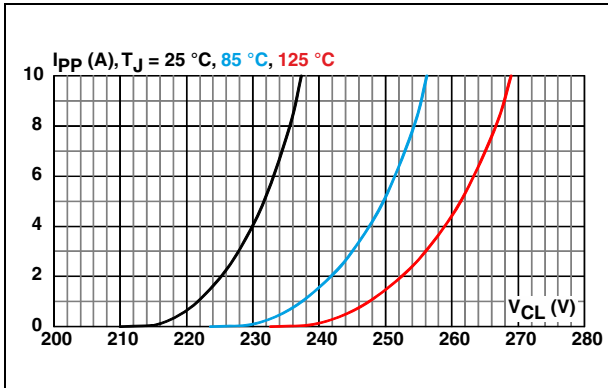

Figure 11. Clamping voltage versus peak pulse current - STRVS280X02F

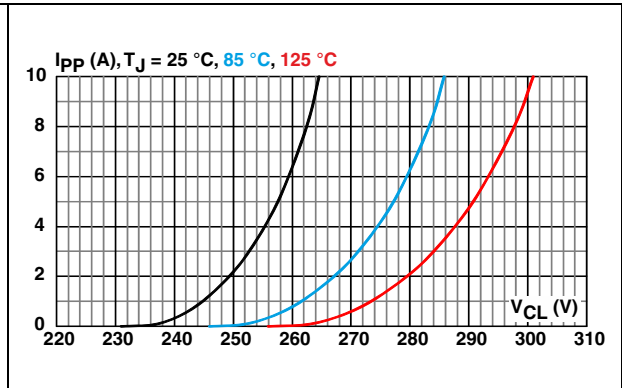

Figure 12. Leakage current versus junction temperature (typical values) STRVSxxxC

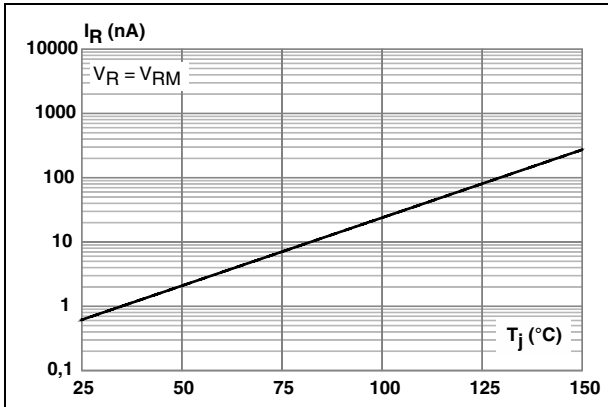

Figure 13. Leakage current versus junction temperature (typical values) STRVSxxxF

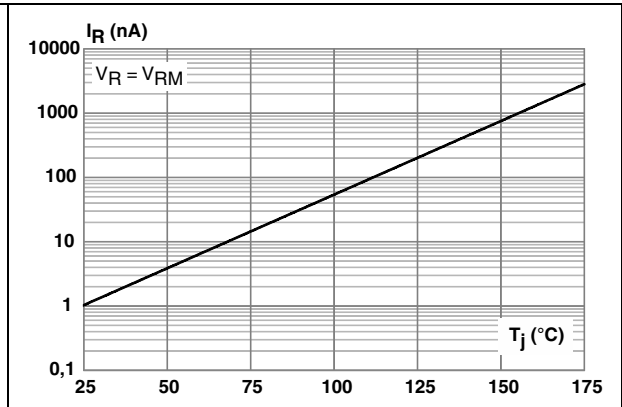

Figure 14. Leakage current versus junction temperature (typical values) STRVSxxxB

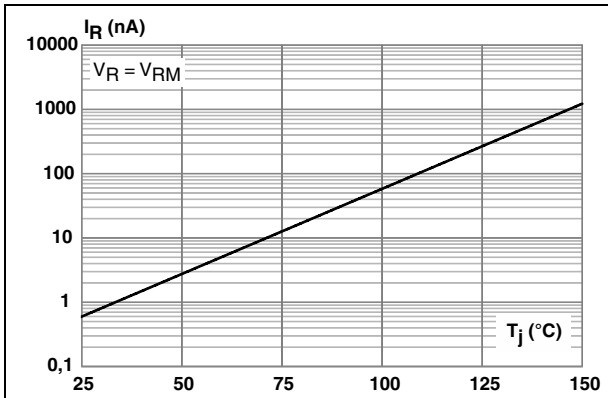
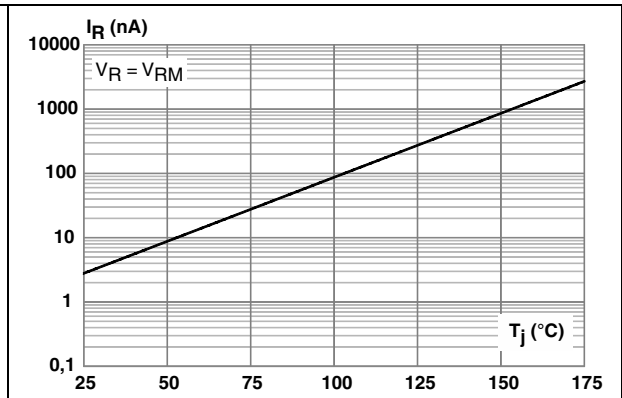
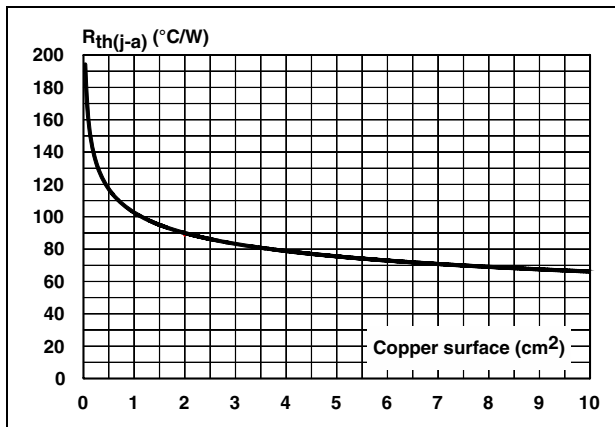

Figure 15. Leakage current versus junction temperature (typical values) STRVSxxxE



**Figure 16. Thermal resistance junction to ambient versus copper surface of connections - SMB**



**Figure 17. Thermal resistance junction to ambient versus copper surface of connections - SMC**

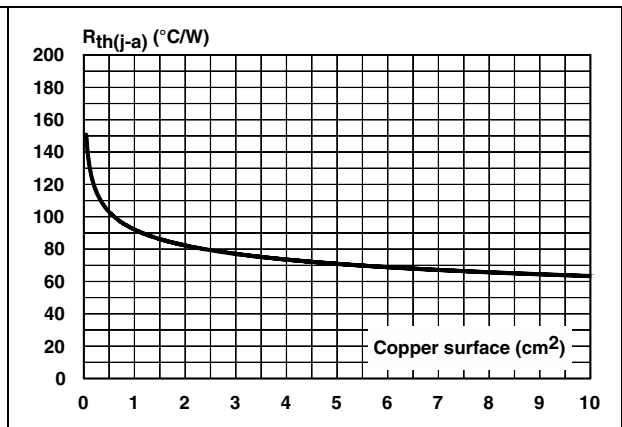

**Figure 18. Thermal resistance junction to ambient versus copper surface of connections - DO-15**

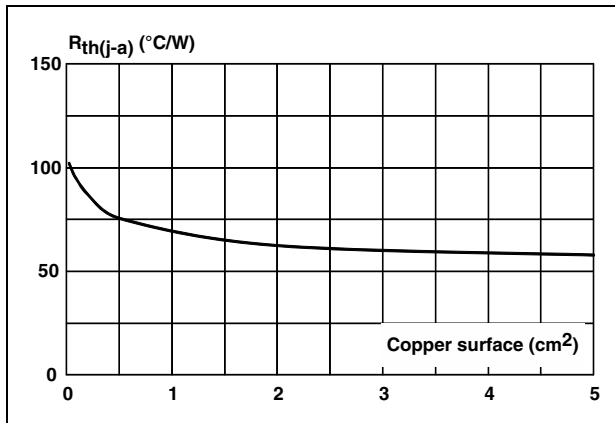

**Figure 19. Thermal resistance junction to ambient versus copper surface of connections - DO-201**

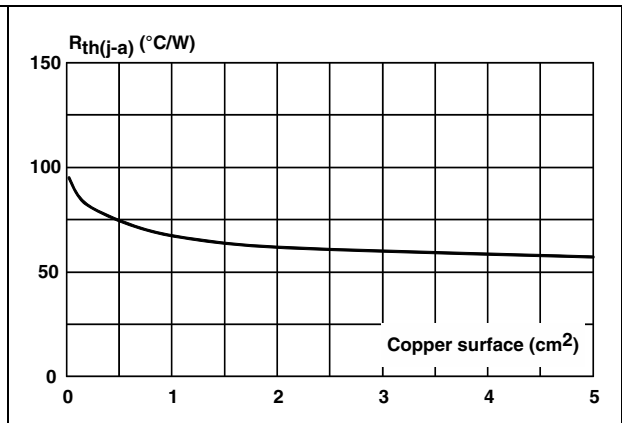

## 2 Package information

- Epoxy meets UL94, V0
- Lead-free package
- Polarity: band indicates cathode
- Terminals: solder plated, solderable as per MIL-STD-750, method 2026

In order to meet environmental requirements, ST offers these devices in different grades of ECOPACK<sup>®</sup> packages, depending on their level of environmental compliance. ECOPACK<sup>®</sup> specifications, grade definitions and product status are available at: [www.st.com](http://www.st.com). ECOPACK<sup>®</sup> is an ST trademark.

### 2.1 SMB package information

Figure 20. SMB dimension definitions

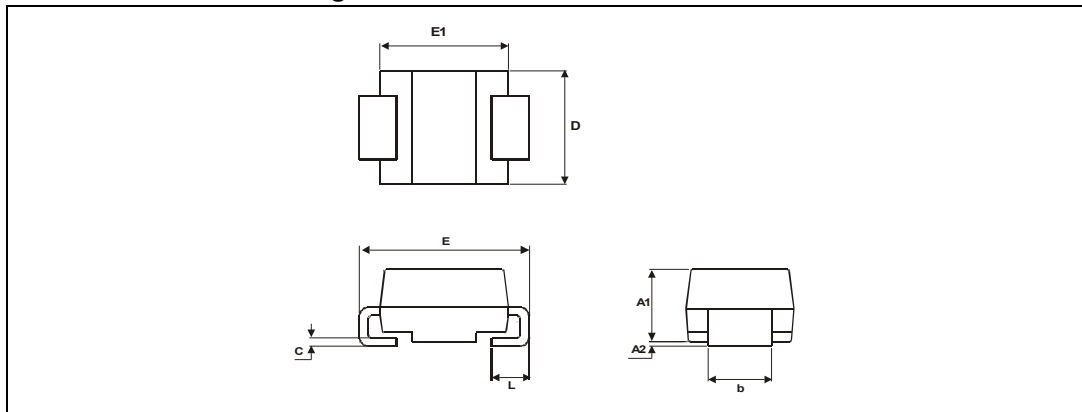

Table 5. SMB dimension values

Ref.	Dimensions			
	Millimeters		Inches	
	Min.	Max.	Min.	Max.
A1	1.90	2.45	0.075	0.096
A2	0.05	0.20	0.002	0.008
b	1.95	2.20	0.077	0.087
c	0.15	0.40	0.006	0.016
D	3.30	3.95	0.130	0.156
E	5.10	5.60	0.201	0.220
E1	4.05	4.60	0.159	0.181
L	0.75	1.50	0.030	0.059

Figure 21. SMB Footprint, dimensions in mm (inches)

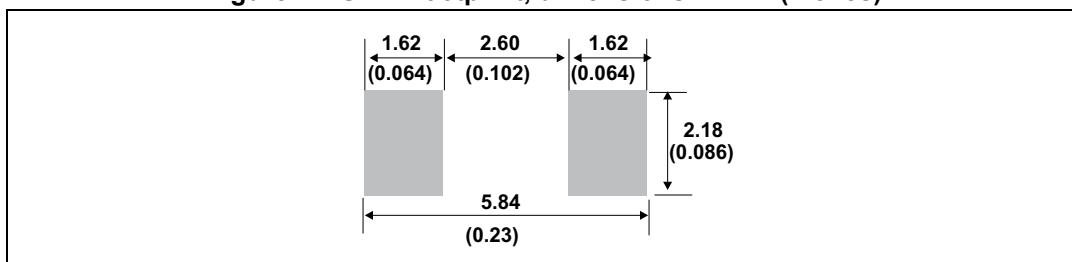
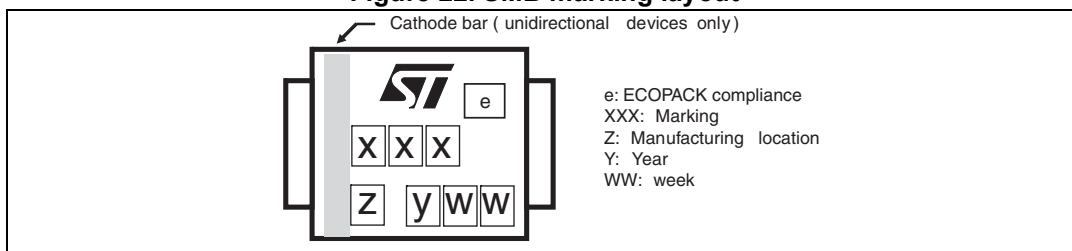

Figure 22. SMB marking layout





## 2.2 SMC package information

Figure 23. SMC dimension definitions

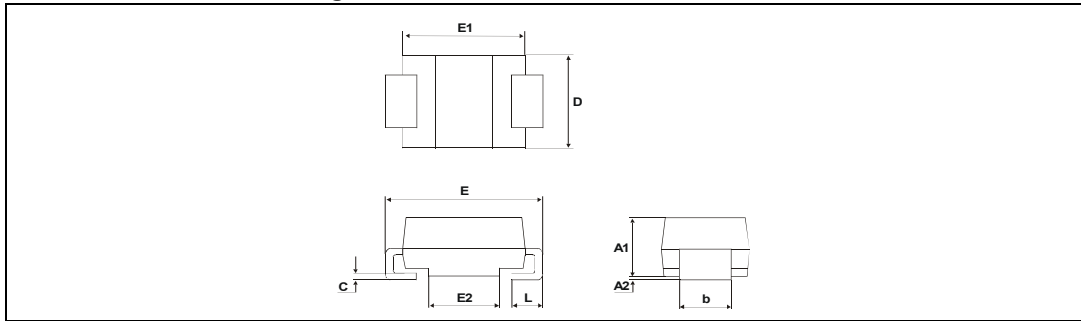

Table 6. SMC dimension values

Ref.	Dimensions			
	Millimeters		Inches	
	Min.	Max.	Min.	Max.
A1	1.90	2.45	0.075	0.096
A2	0.05	0.20	0.002	0.008
b	2.90	3.20	0.114	0.126
c	0.15	0.40	0.006	0.016
D	5.55	6.25	0.218	0.246
E	7.75	8.15	0.305	0.321
E1	6.60	7.15	0.260	0.281
E2	4.40	4.70	0.173	0.185
L	0.75	1.50	0.030	0.059

Figure 24. SMC footprint, dimensions in mm (inches)

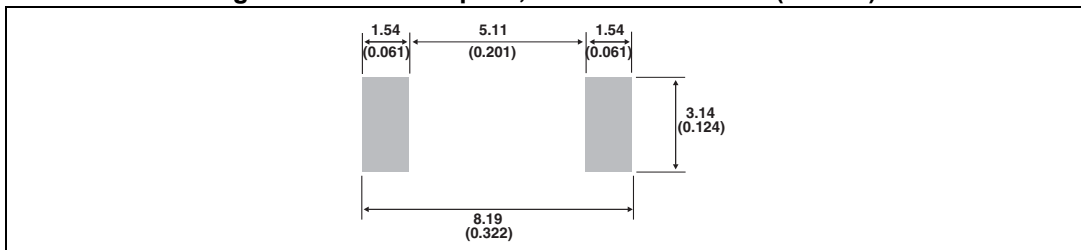
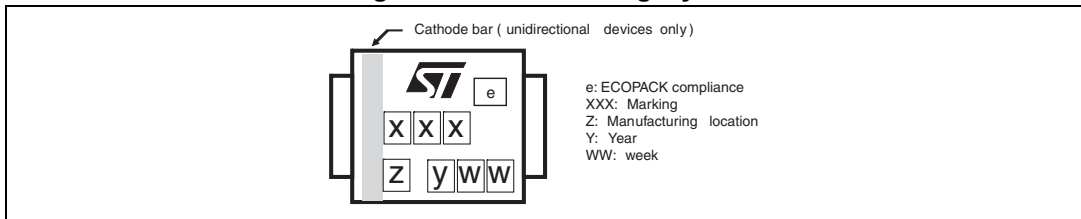

Figure 25. SMC marking layout



## 2.3 DO-15 package information

Figure 26. DO-15 dimension definitions

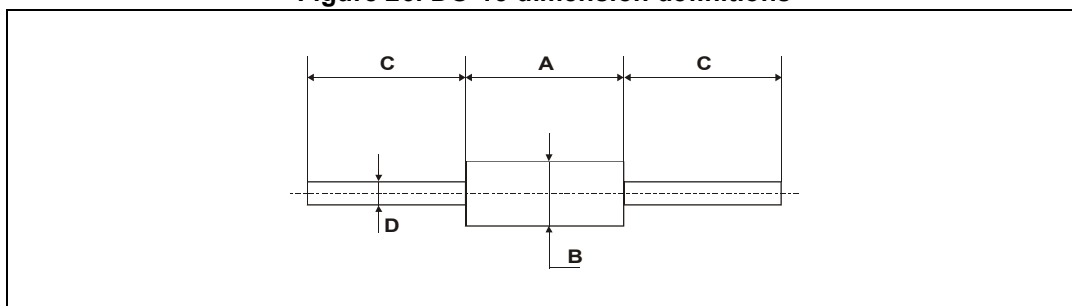

Table 7. DO-15 dimension values

Ref.	Dimensions			
	Millimeters		Inches	
	Min.	Max.	Min.	Max.
A	6.05	6.75	0.238	0.266
B	2.95	3.53	0.116	0.139
C	26	31	1.024	1.220
D	0.71	0.88	0.028	0.035

## 2.4 DO-201 package information

Figure 27. DO-201 dimension definitions

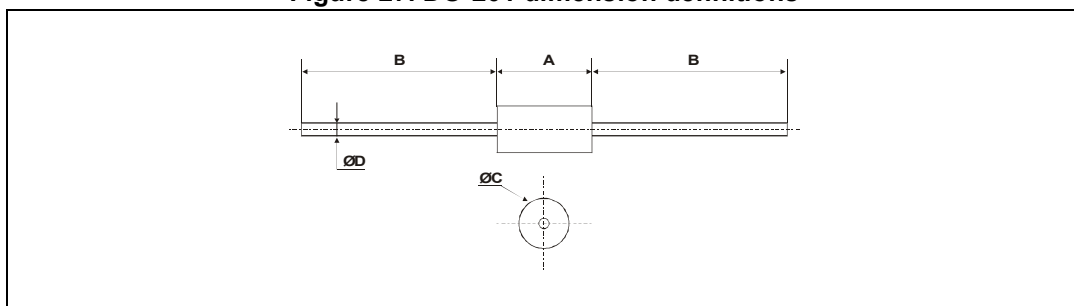

Table 8. DO-201 dimension values

Ref.	Dimensions			
	Millimeters		Inches	
	Min.	Max.	Min.	Max.
A	8.5	9.5	0.335	0.374
B	25.4		1	
Ø C	4.8	5.3	0.189	0.209
Ø D	0.96	1.06	0.038	0.042

### 3 Ordering information

Figure 28. Ordering information scheme

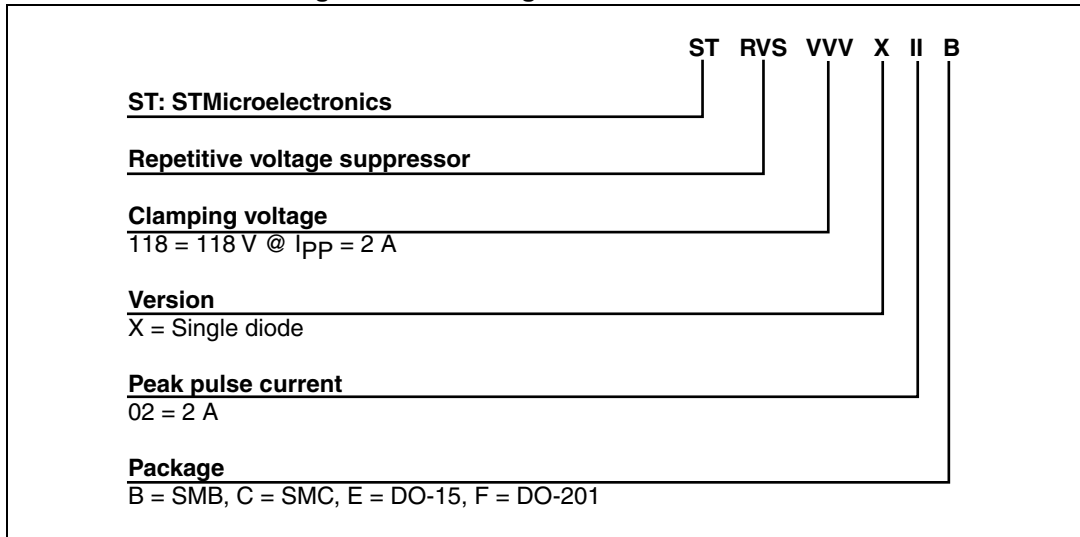

Table 9. Ordering information

Order code	Marking	Package	Weight	Base qty.	Delivery mode
STRVS118X02C	R118C	SMC	0.25 g	2500	Tape and reel
STRVS142X02F	R142F	DO-201	0.90 g	600	Ammopack
STRVS182X02F	R182F	DO-201	0.90 g	600	Ammopack
STRVS185X02B	R185B	SMB	0.12 g	2500	Tape and reel
STRVS185X02E	R185E	DO-15	0.40 g	1000	Ammopack
STRVS222X02F	R222F	DO-201	0.90 g	600	Ammopack
STRVS225X02E	R225E	DO-15	0.40 g	1000	Ammopack
STRVS241X02E	R241E	DO-15	0.40 g	1000	Ammopack
STRVS248X02C	R4248C	SMC	0.25 g	2500	Tape and reel
STRVS252X02F	R252F	DO-201	0.90 g	600	Ammopack
STRVS280X02F	R280F	DO-201	0.90 g	600	Ammopack

## 4 Revision history

**Table 10. Document revision history**

Date	Revision	Changes
05-Mar-2013	1	Initial release.
18-Apr-2013	2	Insertion of <a href="#">Table 1</a> .
15-Oct-2013	3	Updated <a href="#">Table 1</a> .
14-Sep-2015	4	Updated features on cover page and <a href="#">Figure 21</a> . Updated <a href="#">Table 3</a> , <a href="#">Table 4</a> , <a href="#">Table 6</a> and <a href="#">Table 9</a> . Minor text changes.

**IMPORTANT NOTICE – PLEASE READ CAREFULLY**

STMicroelectronics NV and its subsidiaries ("ST") reserve the right to make changes, corrections, enhancements, modifications, and improvements to ST products and/or to this document at any time without notice. Purchasers should obtain the latest relevant information on ST products before placing orders. ST products are sold pursuant to ST's terms and conditions of sale in place at the time of order acknowledgement.

Purchasers are solely responsible for the choice, selection, and use of ST products and ST assumes no liability for application assistance or the design of Purchasers' products.

No license, express or implied, to any intellectual property right is granted by ST herein.

Resale of ST products with provisions different from the information set forth herein shall void any warranty granted by ST for such product.

ST and the ST logo are trademarks of ST. All other product or service names are the property of their respective owners.

Information in this document supersedes and replaces information previously supplied in any prior versions of this document.

© 2015 STMicroelectronics – All rights reserved