

GPDC0799

RECTIFIER DIODE

Low profile ceramic package
 Spot welding applications
 Electroplating applications

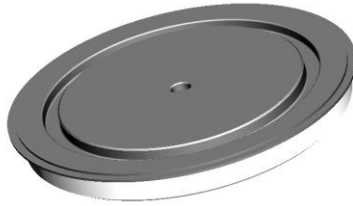

VOLTAGE UP TO 200 V
AVERAGE CURRENT 7990 A
SURGE CURRENT 55 kA

BLOCKING CHARACTERISTICS

Characteristic		Conditions	Value
V _{RRM}	Repetitive peak reverse voltage		200 V
V _{RSM}	Non-repetitive peak reverse voltage		300 V
I _{RRM}	Repetitive peak reverse current, max.	V _{RRM} , single phase, half wave, T _j = T _{jmax}	50 mA

FORWARD CHARACTERISTICS

I _{F(AV)}	Average forward current	Sine wave, 180° conduction, T _c = 70°C	7990 A
I _{F(RMS)}	R.M.S. forward current	Sine wave, 180° conduction, T _c = 70°C	12551 A
I _{FSM}	Surge forward current	Non rep. half sine wave, 50 Hz, V _R = 0 V, T _j = T _{jmax}	55 kA
I ² t	I ² t for fusing coordination		15125 kA ² s
V _{F(TO)}	Threshold voltage	T _j = T _{jmax}	0.74 V
r _F	Forward slope resistance	T _j = T _{jmax}	0.026 mΩ
V _{FM}	Peak forward voltage, max	Forward current I _F = 5000 A, T _j = 25°C	1.05 V

SWITCHING CHARACTERISTICS

Q _{rr}	Reverse recovery charge, typ	T _j = T _{jmax} , I _F = 1000 A, di/dt = -30 A/μs	500 μC
I _{rr}	Reverse recovery current	V _R = 100 V	A
t _{rr}	Reverse recovery time		μs
V _{FP}	Forward recovery voltage	T _j = T _{jmax} , di/dt = A/μs	V

THERMAL AND MECHANICAL CHARACTERISTICS

R _{th(j-c)}	Thermal resistance (junction to case)	Double side cooled	0.010 °C/W
R _{th(c-h)}	Thermal resistance (case to heatsink)	Double side cooled	0.005 °C/W
T _{jmax}	Max operating junction temperature		170 °C
T _{stg}	Storage temperature		-40 / 170 °C
F	Clamping force ± 10%		22 kN
	Mass		150 g

Current rating - sine wave

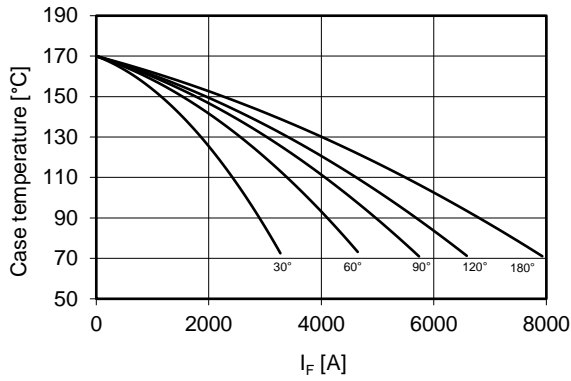

Power loss - sine wave

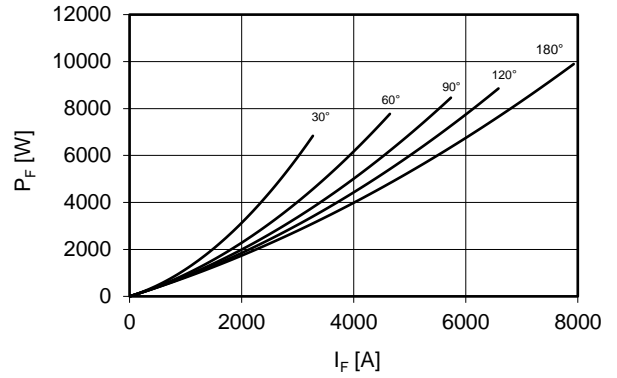

Maximum surge current d.s. cooled

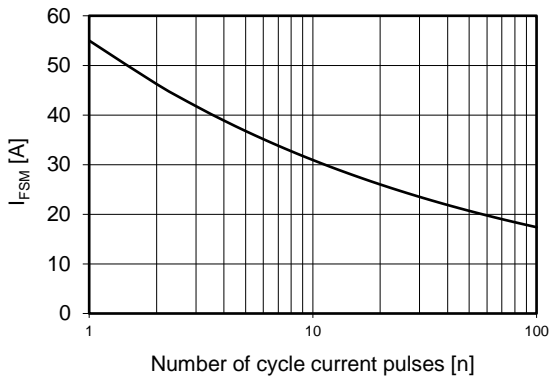

Forward voltage drop

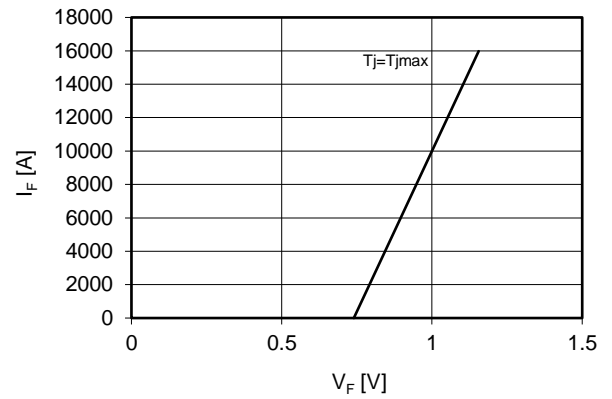

Thermal Impedance (j-c)

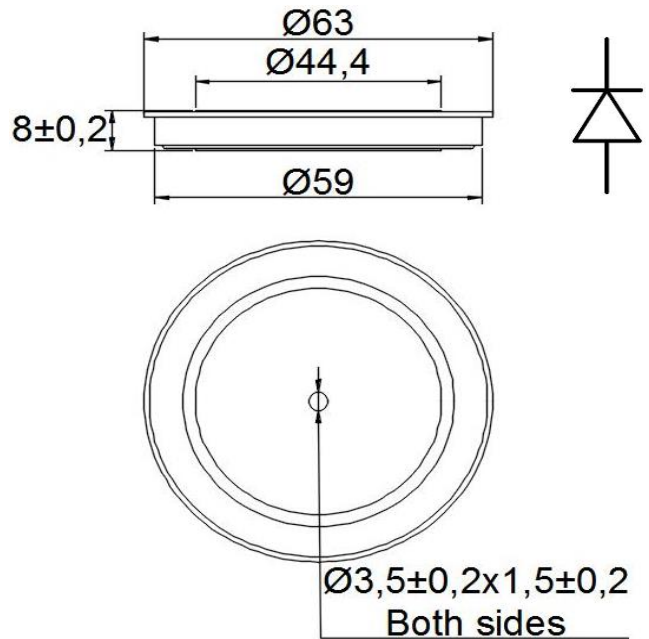
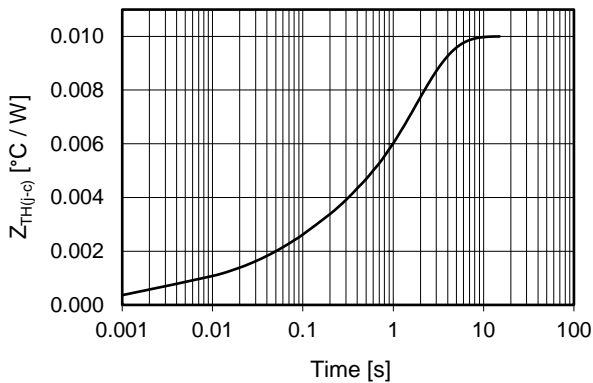

Ordering information GPDC0799-VV

VV: blocking voltage / 100 (e.g. 02 for 200V)

In the interest of product improvement Green Power Solutions reserves the right to change any specification given in this data sheet without notice.