

**Chip EMIFIL®Chip 3-terminal Capacitor for General  
NFM15CC222D1A3\_ (0402, 2200pF, DC10V)**

\_ : packaging code

**Reference Sheet**

**1.Scope**

This product specification is applied to Chip EMIFIL®Chip 3-terminal Capacitor used for General Electronic equipment.

**2.MURATA Part NO. System**

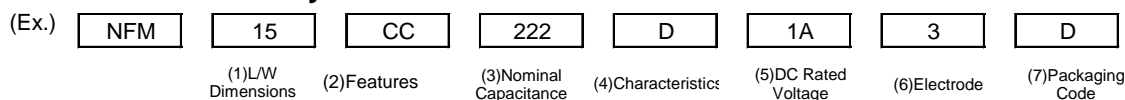

**3. Type & Dimensions**



a)Equivalent Circuit

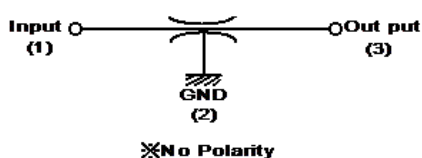

(Unit:mm)

|          |          |         |          |          |
|----------|----------|---------|----------|----------|
| (1)-1 L  | (1)-2 W  | T       | e        | g        |
| i        | j        |         |          |          |
| 1.0±0.1  | 0.5±0.2  | 0.4±0.1 | 0.17±0.1 | 0.1 min. |
| 0.35±0.1 | 0.15±0.1 |         |          |          |

**4.Rated value**

| (3) Nominal Capacitance | Capacitance Tolerance | (5) DC Rated Voltage | Rated Current (mA) | DC Resistance | Insulation Resistance | Specifications and Test Methods (Operating /Storage Temp. Range) |
|-------------------------|-----------------------|----------------------|--------------------|---------------|-----------------------|--|
| 2200 pF                 | ±20 %                 | DC 10 V              | 1A(DC)             | 40mΩmax.      | 1000MΩmin.            | -55 to 105 °C / -55 to 105 °C                                    |

**5.Package**

| mark | (7) Packaging             | Packaging Unit  |
|------|---------------------------|-----------------|
| D    | φ180mm Reel<br>PAPER W8P2 | 10000 pcs./Reel |

Product specifications in this catalog are as of Mar.7,2016,and are subject to change or obsolescence without notice.  
Please consult the approval sheet before ordering.  
Please read rating and !Cautions first.

■ SPECIFICATIONS AND TEST METHODS

Electrical Performance

| No | Item                        | Specification                  | Test Method   |
|----|-----------------------------|--------------------------------|---|
| 1  | Capacitance (Cap.)          | Shown in Rated value.          | Frequency : 1.0±0.1kHz<br>Voltage : 1V±0.2V(rms)                                      |
| 2  | Insulation Resistance(I.R.) |                                | Voltage : Rated Voltage<br>Time : 2 minutes max.                                      |
| 3  | DC Resistance               |                                | Measured with 100mA max.  |
| 4  | Withstanding Voltage        | Products shall not be damaged. | Test Voltage : Rated Voltage x 300%<br>Time : 1 to 5 s<br>Charge Current : 50 mA max. |
| 5  | Operating Temperature       | Shown in Rated value.          | Includes self-heating   |
| 6  | Storage Temperature         |                                |   |

Standard Testing Condition

< Unless otherwise specified >

Temperature : Ordinary Temp. / 15 °C to 35 °C

Humidity: Ordinary Humidity / 25 %(RH) to 85 %(RH)

< In case of doubt >

Temperature: 20 °C ± 2 °C

Humidity: 60 %(RH) to 70 %(RH)

Atmospheric pressure: 86 kPa to 106 kPa

■ SPECIFICATIONS AND TEST METHODS

Mechanical Performance

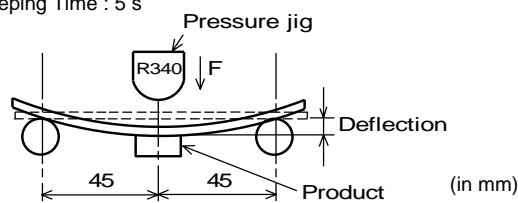
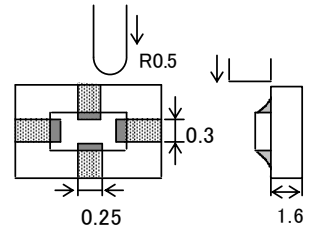
| No            | Item                          | Specification   | Test Method  |            |             |                               |               |                               |  |            |   |
|---------------|-------------------------------|---|--|------------|-------------|-------------------------------|---------------|-------------------------------|--|------------|---|
| 1             | Appearance and Dimensions     | Appearance:No defects or abnormalities.<br>Dimensions:Within the specified dimensions.  | Appearance:Visual inspection.<br>Dimensions:Using calipers.  |            |             |                               |               |                               |  |            |   |
| 2             | Solderability                 | Electrodes shall be at least 90% covered with new solder coating.   | Flux : Ethanol solution of rosin, 25(wt)%<br>Pre-heat : 150±10°C, 60 to 90s<br>Solder : Sn-3.0Ag-0.5Cu<br>Solder Temperature : 240 ± 3°C<br>Immersion Time : 3±1 s<br>Immersion and emersion rates : 25mm / s        |            |             |                               |               |                               |  |            |   |
| 3             | Resistance to soldering heat  | Meet Table 1.<br><table border="1"> <tr> <td>Appearance</td> <td>No damaged</td> </tr> <tr> <td>Cap. Change</td> <td>Within ±7.5%</td> </tr> <tr> <td>I.R.</td> <td>Meet the initial rated value.</td> </tr> <tr> <td>DC Resistance</td> <td>0.05Ω max.</td> </tr> </table> | Appearance   | No damaged | Cap. Change | Within ±7.5%                  | I.R.          | Meet the initial rated value. | DC Resistance  | 0.05Ω max. | Flux : Ethanol solution of rosin, 25(wt)%<br>Pre-heat : 150±10°C, 60 to 90s<br>Solder : Sn-3.0Ag-0.5Cu<br>Solder Temperature : 270 ± 5°C<br>Immersion Time : 10 ± 1 s<br>Immersion and emersion rates : 25mm / s<br>Initial values :<br>measured after heat treatment (150+0 / -10 °C,1hour) and exposure in the room condition for 48±4 hours.<br>Then measured after exposure in the room condition for 48±4 hours. |
| Appearance    | No damaged                    |   |  |            |             |                               |               |                               |  |            |   |
| Cap. Change   | Within ±7.5%                  |   |  |            |             |                               |               |                               |  |            |   |
| I.R.          | Meet the initial rated value. |   |  |            |             |                               |               |                               |  |            |   |
| DC Resistance | 0.05Ω max.                    |   |  |            |             |                               |               |                               |  |            |   |
| 4             | Bending Strength              | Meet Table 2.<br><table border="1"> <tr> <td>Appearance</td> <td>No damaged</td> </tr> <tr> <td>Cap. Change</td> <td>Within ±7.5%</td> </tr> <tr> <td>DC Resistance</td> <td>0.05Ω max.</td> </tr> </table>   | Appearance   | No damaged | Cap. Change | Within ±7.5%                  | DC Resistance | 0.05Ω max.                    | It shall be soldered on the glass-epoxy substrate (100 × 40 × 0.8mm).<br>Deflection : 1.0 mm<br>Keeping Time : 5 s<br>  |            |   |
| Appearance    | No damaged                    |   |  |            |             |                               |               |                               |  |            |   |
| Cap. Change   | Within ±7.5%                  |   |  |            |             |                               |               |                               |  |            |   |
| DC Resistance | 0.05Ω max.                    |   |  |            |             |                               |               |                               |  |            |   |
| 5             | Drop                          | Products shall be no failure after tested.  | It shall be dropped on concrete or steel board.<br>Height : 1m<br>Method : Free fall<br>Attitude from which the product is dropped : 3 directions<br>The Number of Time : 3 times for each direction (Total 9 times) |            |             |                               |               |                               |  |            |   |
| 6             | Bonding Strength              | The electrodes shall be no failure after tested.  | It shall be soldered on the glass-epoxy substrate.<br>Applying Force (F) : 5 N<br>Applying Time : 5 s<br>                        |            |             |                               |               |                               |  |            |   |
| 7             | Vibration                     | Meet Table 3.<br><table border="1"> <tr> <td>Appearance</td> <td>No damaged</td> </tr> <tr> <td>Capacitance</td> <td>Meet the initial rated value.</td> </tr> <tr> <td>DC Resistance</td> <td>0.05Ω max.</td> </tr> </table>  | Appearance   | No damaged | Capacitance | Meet the initial rated value. | DC Resistance | 0.05Ω max.                    | It shall be soldered on the glass-epoxy substrate.<br>Oscillation Frequency : 10 to 2000 to 10Hz for 20 minute.<br>Total amplitude 3.0 mm or Acceleration amplitude 196m/s <sup>2</sup> whichever is smaller.<br>Time : A period of 2 hours in each of 3 mutually perpendicular directions. (Total 6 hours)<br>Preconditioning : Heat treatment (150+0 / -10 °C,1hour) |            |   |
| Appearance    | No damaged                    |   |  |            |             |                               |               |                               |  |            |   |
| Capacitance   | Meet the initial rated value. |   |  |            |             |                               |               |                               |  |            |   |
| DC Resistance | 0.05Ω max.                    |   |  |            |             |                               |               |                               |  |            |   |

■ SPECIFICATIONS AND TEST METHODS

Environment Performance

It shall be soldered on the glass-epoxy substrate.

| No            | Item                          | Specification  | Test Method  |            |             |                     |      |                               |               |                    |   |
|---------------|-------------------------------|--|--|------------|-------------|---------------------|------|-------------------------------|---------------|--------------------|---|
| 1             | Temperature Cycling           | Meet Table 4.<br><u>Table 4</u> <table border="1"> <tr> <td>Appearance</td> <td>No damaged</td> </tr> <tr> <td>Cap. Change</td> <td>Within <math>\pm 12.5\%</math></td> </tr> <tr> <td>I.R.</td> <td>Meet the initial rated value.</td> </tr> <tr> <td>DC Resistance</td> <td>0.05<math>\Omega</math> max.</td> </tr> </table> | Appearance   | No damaged | Cap. Change | Within $\pm 12.5\%$ | I.R. | Meet the initial rated value. | DC Resistance | 0.05 $\Omega$ max. | 1 Cycle<br>1 step : Minimum Operating Temperature<br>$+0 / -3^{\circ}\text{C} / 30+3 / -0$ min<br>2 step : Room Temperature / within 3 min<br>3 step : Maximum Operating Temperature<br>$+3 / -0^{\circ}\text{C} / 30 +3 / -0$ min<br>4 step : Room Temperature / within 3 min<br>Total of 10 cycles<br>Initial values : measured after heat treatment(150+0 / -10 $^{\circ}\text{C}$ ,1hour) and exposure in the room condition for 48 $\pm$ 4 hours.<br>Then measured after exposure in the room condition for 48 $\pm$ 4 hours.<br>If it's doubt, the mesuring has to be done after 1 hours curing at 150+0 / -10 $^{\circ}\text{C}$ and 48 $\pm$ 4 hours storage. |
| Appearance    | No damaged                    |  |  |            |             |                     |      |                               |               |                    |   |
| Cap. Change   | Within $\pm 12.5\%$           |  |  |            |             |                     |      |                               |               |                    |   |
| I.R.          | Meet the initial rated value. |  |  |            |             |                     |      |                               |               |                    |   |
| DC Resistance | 0.05 $\Omega$ max.            |  |  |            |             |                     |      |                               |               |                    |   |
| 2             | Humidity                      | Meet Table 5.<br><u>Table 5</u> <table border="1"> <tr> <td>Appearance</td> <td>No damaged</td> </tr> <tr> <td>Cap. Change</td> <td>Within <math>\pm 12.5\%</math></td> </tr> <tr> <td>I.R.</td> <td>105M<math>\Omega</math> min.</td> </tr> <tr> <td>DC Resistance</td> <td>0.05<math>\Omega</math> max.</td> </tr> </table>  | Appearance   | No damaged | Cap. Change | Within $\pm 12.5\%$ | I.R. | 105M $\Omega$ min.            | DC Resistance | 0.05 $\Omega$ max. | Temperature : 40 $\pm$ 2 $^{\circ}\text{C}$<br>Humidity : 90 to 95%(RH)<br>Time : 500+24 / -0 hours<br>Initial values: measured after heat treatment (150+0 / -10 $^{\circ}\text{C}$ , 1hour) and exposure in the room condition for 48 $\pm$ 4 hours.<br>Then measured after exposure in the room condition for 48 $\pm$ 4 hours.<br>If it's doubt, the mesuring has to be done after 1 hours curing at 150+0 / -10 $^{\circ}\text{C}$ and 48 $\pm$ 4 hours storage.   |
| Appearance    | No damaged                    |  |  |            |             |                     |      |                               |               |                    |   |
| Cap. Change   | Within $\pm 12.5\%$           |  |  |            |             |                     |      |                               |               |                    |   |
| I.R.          | 105M $\Omega$ min.            |  |  |            |             |                     |      |                               |               |                    |   |
| DC Resistance | 0.05 $\Omega$ max.            |  |  |            |             |                     |      |                               |               |                    |   |
| 3             | Heat Life                     |  | Temperature : : Maximum Operating Temperature $\pm 2^{\circ}\text{C}$<br>Test Voltage : Rated Voltage x 150%<br>Charge Current : 50 mA max.<br>Time : 1000+48 / -0 hours<br>Initial values: measured after heat treatment (150+0 / -10 $^{\circ}\text{C}$ , 1hour) and exposure in the room condition for 48 $\pm$ 4 hours.<br>Then measured after exposure in the room condition for 48 $\pm$ 4 hours.<br>If it's doubt, the mesuring has to be done after 1 hours curing at 150+0 / -10 $^{\circ}\text{C}$ and 48 $\pm$ 4 hours storage. |            |             |                     |      |                               |               |                    |   |

1. Appearance and Dimensions (8mm-wide paper tape)

<Fig.1>

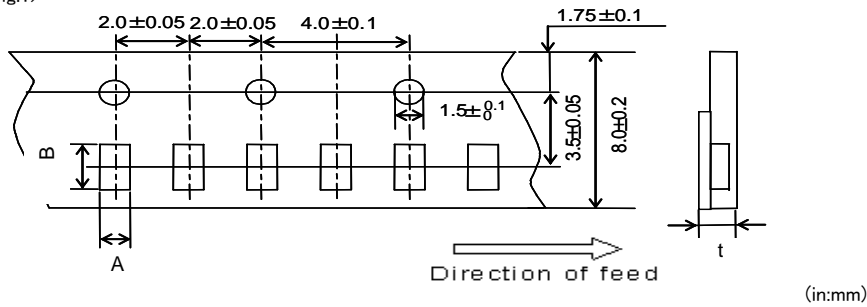

<Fig.2>

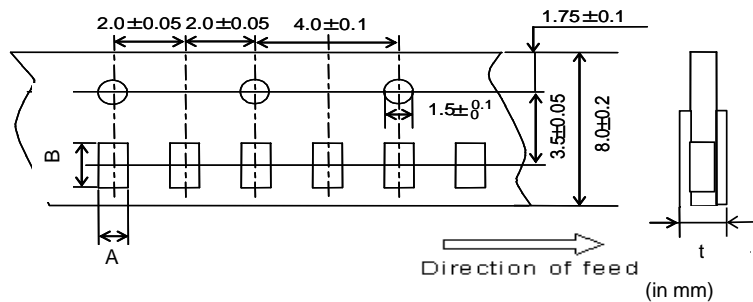

| Code | NFM15PC474/105 | NFM15CC series<br>NFM15PC473/104/224/435 | NFM15PC755 | NFM15PC915 |
|------|----------------|--|------------|------------|
| Fig. | Fig.1          | Fig.1                                    | Fig.2      | Fig.2      |
| A    | 0.65 *         | 0.75 *                                   | 0.72 *     | 0.78 *     |
| B    | 1.15 *         | 1.15 *                                   | 1.29 *     | 1.29 *     |
| t    | 0.6 max.       | 0.75 max.                                | 0.9 max.   | 0.9 max.   |

\*typical

2. Specification of Taping

- (1) Packing quantity (standard quantity)  
10,000 pcs. / reel
- (2) Packing Method  
Products shall be packaged in the cavity of the base tape and sealed by cover tape.
- (3) Sprocket Hole  
The sprocket holes are to the right as the tape is pulled toward the user.
- (4) Base tape and Cover tape  
The base tape and Cover tape have no spliced point.
- (5) Cavity  
There shall not be burr in the cavity.
- (6) Missing components number  
Missing components number within 0.1% of the number per reel or 1 pc., whichever is greater, and are not continuous.  
The specified quantity per reel is kept.

3. Pull Strength of Cover tape

5Nmin.

4. Peeling off force of Cover tape

0.1N to 0.6N (minimum value is typical)  
Speed of Peeling off : 300 mm / min

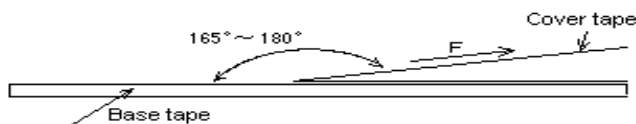

5. Dimensions of Leader-tape, Trailer and Reel

There shall be leader-tape (cover tape and empty tape) and trailer-tape (empty tape) as follows.

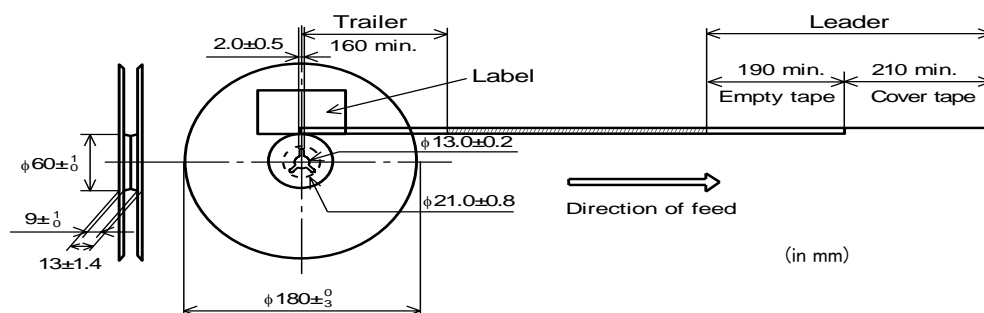

(in mm)

1. Mounting density

Add special attention to radiating heat of products when mounting this product near the products with heating. The excessive heat by other products may cause deterioration of insulation resistance and excessive heat at this product, resulting in a fire.

2. Limitation of Applications

Please contact us before using our products for the applications listed below which require especially high reliability for the prevention of defects which might directly cause damage to the third party's life, body or property.

- (1)Aircraft equipment (2)Aerospace equipment (3)Undersea equipment (4)Power plant control equipment
- (5)Medical equipment (6)Transportation equipment(automobiles, trains, ships, etc.) (7)Traffic signal equipment
- (8)Disaster prevention / crime prevention equipment (9)Data-processing equipment
- (10)Applications of similar complexity or with reliability requirements comparable to the applications listed in the above

Products can only be soldered with reflow.  
 This product is designed for solder mounting.  
 Please consult us in advance for applying other mounting method such as conductive adhesive.

1. Flux and Solder

|        |   |
|--------|---|
| Flux   | Use rosin-based flux, Do not use highly acidic flux (with chlorine content exceeding 0.2(wt)%).<br>Do not use water-soluble flux.<br>Other flux (except above) Please contact us for details, then use. |
| Solder | Use Sn-3.0Ag-0.5Cu solder<br>Use of Sn-Zn based solder will deteriorate performance of products.<br>In case of using Sn-Zn based solder, please contact Murata in advance.                              |

2. Note for Assembling

< Points of Attention about NFM Pattern Forms >

The loaded stresses are different to a chip depend on PCB materials and structures.  
 When the chip will be mounted on the metal PCB contained alumina material, PCB heat expansion/contraction will be a cause of chip cracks because the coefficients of thermal expressions are different between metal PCB and the chip itself. In case of mounting 1005M or smaller size of NFM on single-layered glass epoxy board, chip cracks will be occurred because of the same reason.

< Thermal Shock >

Pre-heating should be in such a way that the temperature difference between solder and products surface is limited to 100°C max. Also cooling into solvent after soldering should be in such a way that the temperature difference is limited to 100°C max.

3. Attention Regarding P.C.B. Bending

The following shall be considered when designing P.C.B.'s and laying out products.

(1) P.C.B. shall be designed so that products are not subject to the mechanical stress for board warpage.

[Products direction]

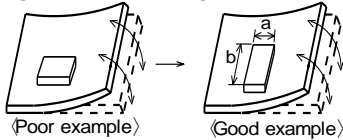

Products shall be located in the sideways direction (Length:a<b) to the mechanical stress.

(2) Products location on P.C.B. near seam for separation.

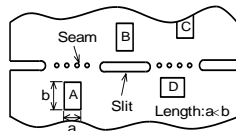

Products (A,B,C,D) shall be located carefully so that products are not subject to the mechanical stress due to warping the board. Because they may be subjected the mechanical stress in order of A>C>B≐D.

4. Pre-heating Temperature

Soldering shall be handled so that the difference between pre-heating temperature and solder temperature shall be limited to 100°C max. to avoid the heat stress for the products.

5. Reflow Soldering

1) Soldering paste printing for reflow

- Standard thickness of solder paste: 100µm to 150µm.
- Use the solder paste printing pattern of the right pattern.
- For the resist and copper foil pattern, use standard land dimensions

• Standard printing pattern of solder paste.

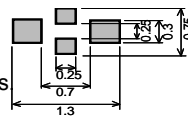

(in mm)

2) Soldering Conditions

Standard soldering profile and the limit soldering profile is as follows.

The excessive limit soldering conditions may cause leaching of the electrode and / or resulting in the deterioration of product quality.

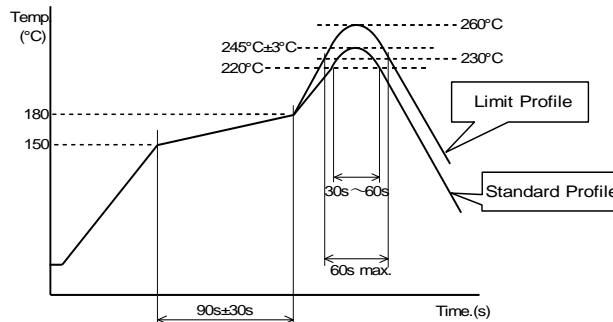

|                  | Standard Profile          | Limit Profile          |
|------------------|---------------------------|------------------------|
| Pre-heating      | 150°C ~ 180°C , 90s ± 30s |                        |
| Heating          | above 220°C , 30s ~ 60s   | above 230°C , 60s max. |
| Peak temperature | 245°C ± 3°C               | 260°C , 10s            |
| Cycle of reflow  | 2 times                   | 2 times                |

6. Reworking with Soldering iron

The following conditions shall be strictly followed when using a soldering iron.

- Tip temperature : 340°C max.
- Tip diameter : φ2mm max.
- Soldering time : 3(+1,-0) s
- Times : 1time only.
- Soldering iron output : 30W max.

Note : Adjust the pre-heat temperature to  $\Delta T < 190^{\circ}\text{C}$  between the component and a soldering iron.  
Do not directly touch the products with the tip of the soldering iron in order to prevent the crack on the material due to the thermal shock.

7. Solder Volume

Solder shall be used not to be exceeded as shown below.

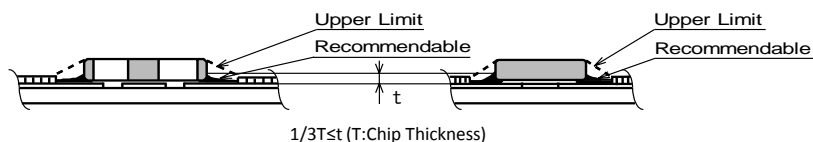

Accordingly increasing the solder volume, the mechanical stress to product is also increased.  
Excessive solder volume may cause the failure of mechanical or electrical performance.

8. Cleaning Conditions

Products shall be cleaned on the following conditions.

- (1) Cleaning temperature shall be limited to 60°C max. (40°C max. for Isopropyl alcohol (IPA))
- (2) Ultrasonic cleaning shall comply with the following conditions, with avoiding the resonance phenomenon at the mounted products and P.C.B.

- Power : 20W / l max.
- Frequency : 28kHz to 40kHz
- Time : 5 minutes max.

(3) Cleaner

1. Cleaner  
Isopropyl alcohol (IPA)
2. Aqueous agent  
PINE ALPHA ST-100S

(4) There shall be no residual flux and residual cleaner after cleaning.

In the case of using aqueous agent, products shall be dried completely after rinse with de-ionized water in order to remove the cleaner.

(5) Other cleaning  
Please contact us.

9. Operating Environment

Do not use this product under the following environmental conditions, on deterioration of the performance, such as insulation resistance may result from the use.

- (1) in the corrodible atmosphere (acidic gases, alkaline gases, chlorine, sulfur gases, organic gases and etc.)
- (2) in the atmosphere where liquid such as organic solvent, may splash on the products.
- (3) in the atmosphere where the temperature / humidity changes rapidly and it is easy to dew.

10. Resin coating

The capacitance value may change and/or it may affect on the product's performance due to high cure-stress of resin to be used for coating / molding products. So please pay your careful attention when you select resin. In prior to use, please make the reliability evaluation with the product mounted in your application set.

11. Handling of a substrate

After mounting products on a substrate, do not apply any stress to the product caused by bending or twisting to the substrate when cropping the substrate, inserting and removing a connector from the substrate or tightening screw to the substrate. Excessive mechanical stress may cause cracking in the product.

Bending

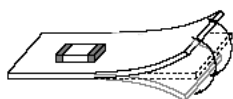

Twisting

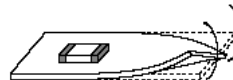



### 12. Component Mounting

If low bottom dead point of the pick-up nozzle is too low, chip cracks will be occurred because an extra power will be added to the chip during mounting. Therefore, the bottom dead point of pick-up nozzle must be set on/over the upper surface of the PCB. Adjusting is required when the bottom dead point will be set by correcting board warp.

It is recommended that using the larger pick-up nozzle than chip length for avoiding what force impact will be centered to the middle point of components. Before assembling, please confirm its mounting accuracy under the best condition.

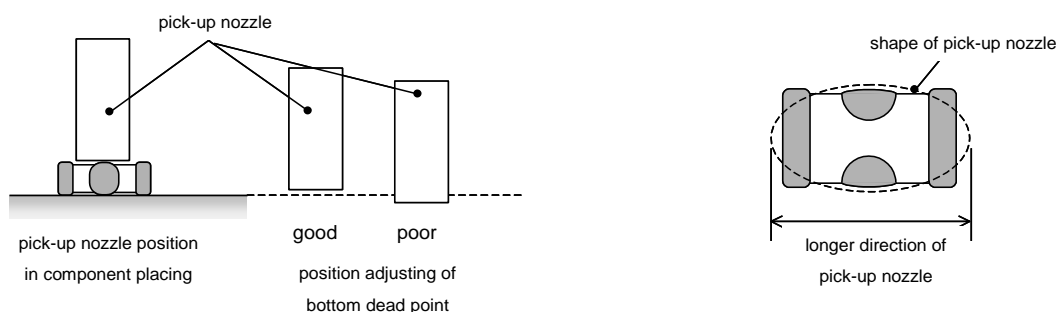

### 13. Standard Land Dimensions

The chip EMI filter suppresses noise by conducting the high-frequency noise element to ground. Therefore, to get enough noise reduction, feed through holes which is connected to ground-plane should be arranged according to the figure to reinforce the ground-pattern.

In case of changing the land dimensions marked by ※, a solder bridge between terminations of the chip could occur. In this case, please contact us before change.

< Standard land dimensions for reflow >

•Side on which chips are mounted

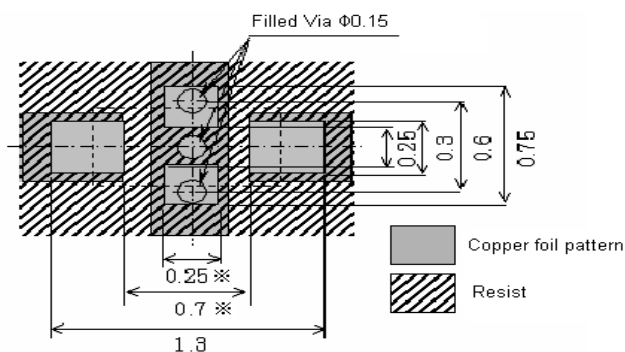

(in mm)

### 14. Storage condition

#### (1) Storage period

Use the products within 12 months after delivered.  
Solderability should be checked if this period is exceeded.

#### (2) Storage environment condition

•Products should be stored in the warehouse on the following conditions.

Temperature: -10 to +40°C

Humidity: 15 to 85% relative humidity

No rapid change on temperature and humidity

•Don't keep products in corrosive gases such as sulfur, chlorine gas or acid, or it may cause oxidization of electrode, resulting in poor solderability.

•Products should be stored on the palette for the prevention of the influence from humidity, dust and so on.

•Products should be stored in the warehouse without heat shock, vibration, direct sunlight and so on.

•Products should be stored under the airtight packaged condition.

#### (3) Delivery

Care should be taken when transporting or handling product to avoid excessive vibration or mechanical shock.

- (1) Please make sure that your product has been evaluated in view of your specifications with our product being mounted to your product.
- (2) You are requested not to use our product deviating from the agreed specifications.
- (3) We consider it not appropriate to include any terms and conditions with regard to the business transaction in the product specifications, drawings or other technical documents. Therefore, if your technical documents as above include such terms and conditions such as warranty clause, product liability clause, or intellectual property infringement liability clause, they will be deemed to be invalid.