

1.5 AMP NEGATIVE ADJUSTABLE VOLTAGE REGULATOR APPROVED TO DESC DRAWING 7703408



**Three Terminal, Precision Adjustable
 Negative Voltage Regulator In Hermetic
 Style Packages (LM137AHV)**

FEATURES

- Similar To Industry Standard LM137AHV
- Approved To DESC Standardized Military Drawing Number 7703408
- Built In Thermal Overload Protection
- Short Circuit Current Limiting
- Available In Six Package Styles
- Maximum Output Voltage Tolerance Is Guaranteed to $\pm 1\%$

DESCRIPTION

These three terminal negative regulators are supplied in hermetically sealed packages. All protective features are designed into the circuit, including thermal shutdown, current-limiting, and safe-area control. With heat sinking, these devices can deliver up to 1.5 amps of output current. The LCC-20 device is limited to .5 amps. The unit also features output voltages that can be fixed from -1.2 volts to -47 volts using external resistors.

ABSOLUTE MAXIMUM RATINGS $T_c @ 25^\circ\text{C}$

Power Dissipation

Case 2	1.1 W
Case-All Others.	20 W

Input - Output Voltage Differential 50 V

Operating Junction Temperature Range - 55°C to + 150°C

Storage Temperature Range - 65°C to + 150°C

Lead Temperature (Soldering 10 seconds) 300°C

Thermal Resistance, Junction to Case:

Case 2, LCC-20	17°C/W
Case U & M, TO-257 (Isol) and SMD-3	4.2°C/W
Case T&N, TO-257 (Non-Isol) and SMD-1	3.5°C/W
Case Y, TO-3	3.0°C/W

Maximum Output Current:

Case 25 A
Case-All Others.	1.5A

Recommended Operating Conditions:

Output Voltage Range	-1.2 to -47 VDC
Ambient Operating Temperature Range (T_A).	- 55°C to + 125°C
Input Voltage Range	-4.25 to -51.25 VDC

3.5

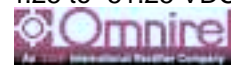

ELECTRICAL CHARACTERISTICS -55°C T_A 125°C, I_L = 8mA (unless otherwise specified)

OM1327NTM, OM1327STM, OM1327NKM, OM1327SMM, OM1327NMM

Parameter	Symbol	Test Conditions	Min.	Max.	Unit
Reference Voltage	V _{REF}	V _{DIFF} = 3.0V, T _A = 25°C	-1.262	-1.238	V
		V _{DIFF} = 3.0V	-1.28	-1.22	
		V _{DIFF} = 50V, T _A = 25°C	-1.28	-1.22	
		V _{DIFF} = 50V	-1.28	-1.22	
Line Regulation (Note 1)	R _{LINE}	3.0 V V _{DIFF} 50V, T _A = 25°C	-6	6	mV
			-20	20	
Load Regulation (Note 1)	R _{LOAD}	V _{DIFF} 50V, 8mA I _L 110mA, T _A = 25°C V _{DIFF} = 5V, 8mA I _L 1.5A, T _A = 25°C	-25	25	mV
			-25	25	
			-50	50	
Thermal Regulation	V _{RTH}	V _{in} = -14.6V, I _L = 1.5A P _d = 20 Watts, t = 10 ms, T _A = 25°C	-5	5	mV
Ripple Rejection (Note 2)	R _N	f = 120 Hz, V _{out} = V _{ref} C _{Adj} = 10 μF	• 66		dB
Adjustment Pin Current	I _{Adj}	V _{DIFF} = 3.0V	•	100	μA
		V _{DIFF} = 40V	•	100	
		V _{DIFF} = 50V	•	100	
Adjustment Pin Current Change	I _{Adj}	V _{DIFF} = 5V, 8mA I _{out} 1.5A	•	-5	μA
		3V V _{DIFF} 50V, I _L 8mA	•	-6	
Minimum Load Current	I _{Lmin}	V _{DIFF} = 3.0V, V _{out} = -1.4V (forced)	•	3.0	mA
		V _{DIFF} = 10V, V _{out} = -1.4V (forced)	•	3.0	
		V _{DIFF} = 40V, V _{out} = -1.4V (forced)	•	5.0	
		V _{DIFF} = 50V, V _{out} = -1.4V (forced)	•	5.0	
Current Limit (Note 2)	I _{CL}	V _{DIFF} = 5V	• 1.5	3.5	A
		V _{DIFF} = 50V, T _A = 25°C	• 0.2	1.0	

Notes:

1. Load and Line Regulation are specified at a constant junction temperature. Pulse testing with low duty cycle is used. Changes in output voltage due to heating effects must be taken into account separately.
2. If not tested, shall be guaranteed to the specified limits.
3. The • denotes the specifications which apply over the full operating temperature range.

3.5

PART NUMBER DESIGNATOR		
Standard Military Drawing Number	Omnirel Part Number	Omnirel Package Designation
7703408M	OM1327SMM	SMD-3
7703408U	OM1327STM	TO-257 (Isolated)
7703408T	OM1327NTM	TO-257 (non-Isolated)
7703408Y	OM1327NKM	TO-3
7703408N	OM1327NMM	SMD-1
7703408Z	OM1327N2M	LCC-20



ELECTRICAL CHARACTERISTICS -55°C T_A 125°C, $I_L = 8\text{mA}$ (unless otherwise specified)
OM1327N2M

Parameter	Symbol	Test Conditions	Min.	Max.	Unit
Reference Voltage	V_{REF}	$ V_{DIFF} = 3.0\text{V}, T_A = 25^\circ\text{C}$ $ V_{DIFF} = 3.0\text{V}$ $ V_{DIFF} = 40\text{V}, T_A = 25^\circ\text{C}$ $ V_{DIFF} = 40\text{V}$ $ V_{DIFF} = 50\text{V}, T_A = 25^\circ\text{C}$ $ V_{DIFF} = 50\text{V}$	-1.262 -1.28 -1.28 -1.28 -1.28	-1.235 -1.22 -1.22 -1.22 -1.22	V
Line Regulation (Note 1)	R_{LINE}	3.0 V $ V_{DIFF} $ 50V, $T_A = 25^\circ\text{C}$	-10 -25	10 25	mV
Load Regulation (Note 1)	R_{LOAD}	$ V_{DIFF} $ 50V, 8mA I_L 100 mA, $T_A = 25^\circ\text{C}$ $ V_{DIFF} = 5\text{V}, 8\text{mA}$ I_L 500 mA, $T_A = 25^\circ\text{C}$	-25 -31 -50	25 31 50	mV
Thermal Regulation	V_{RTH}	$V_{in} = -16.25\text{V}, I_L = 330\text{mA}$ $P_d = 5\text{ Watts}, t = 10\text{ ms}, T_A = 25^\circ\text{C}$	-2	2	mV
Ripple Rejection (Note 2)	R_N	$f = 120\text{ Hz}, V_{out} = V_{ref}$ $C_{Adj} = 10\text{ }\mu\text{F}$	66		dB
Adjustment Pin Current	I_{Adj}	$ V_{DIFF} = 3.0\text{V}$ $ V_{DIFF} = 40\text{V}$ $ V_{DIFF} = 50\text{V}$		100 100 100	μA
Adjustment Pin Current Change	I_{Adj}	$ V_{DIFF} = 5\text{V}, 8\text{mA}$ I_{out} 200 mA 3V $ V_{DIFF} $ 50V, I_L 8mA	-5 -6	5 6	μA
Minimum Load Current	I_{Lmin}	$ V_{DIFF} = 3.0\text{V}, V_{out} = -1.4\text{V}$ (forced) $ V_{DIFF} = 10\text{V}, V_{out} = -1.4\text{V}$ (forced) $ V_{DIFF} = 40\text{V}, V_{out} = -1.4\text{V}$ (forced) $ V_{DIFF} = 50\text{V}, V_{out} = -1.4\text{V}$ (forced)		3.0 3.0 5.0 5.0	mA
Current Limit (Note 2)	I_{CL}	$ V_{DIFF} = 5\text{V}$ $ V_{DIFF} = 50\text{V}, T_A = 25^\circ\text{C}$	0.5 0.1	1.8 0.65	A

Notes:

1. Load and Line Regulation are specified at a constant junction temperature. Pulse testing with low duty cycle is used. Changes in output voltage due to heating effects must be taken into account separately.

TYPICAL APPLICATION

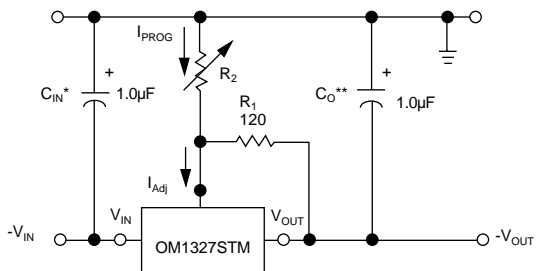

* C_{in} is required if regulator is located more than 4 inches from power supply filter. A 1 μF solid tantalum or 10 μF aluminum electrolytic is recommended.

** C_o is necessary for stability. A 1 μF solid tantalum or 10 μF aluminum electrolytic is recommended.

$$V_{out} = -1.25\text{ V} \left(1 + \frac{R_2}{R_1} \right)$$

3.5



MECHANICAL OUTLINE

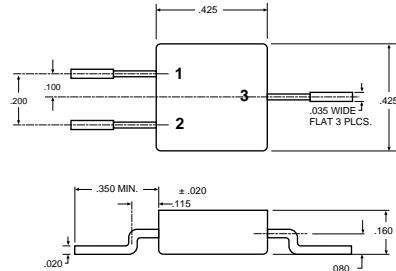
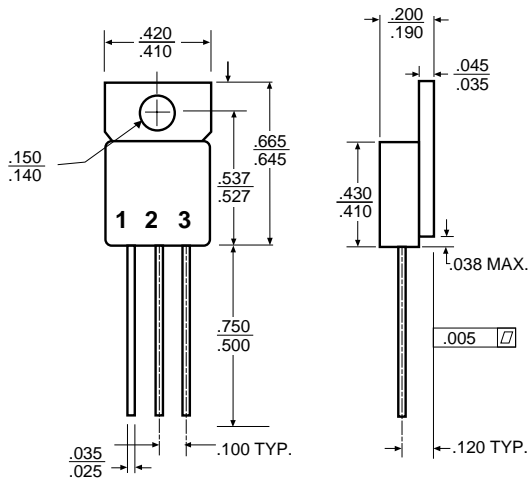

OM1327SMM
 Front View
 Pin 1 - Adjust
 Pin 2 - Output
 Pin 3 - Input
 Case - Isolated

OM1327STM
 Isolated
 Front View
 Pin 1 - Adjust
 Pin 2 - Input
 Pin 3 - Output
 Tab - Isolated

OM1327NTM
 Non-Isolated
 Front View
 Pin 1 - Adjust
 Pin 2 - Input
 Pin 3 - Output
 Tab - Input

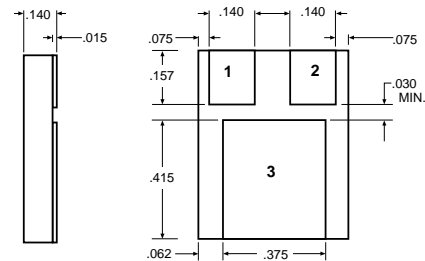

OM1327NMM
 Pin 1 - Adjust
 Pin 2 - Output
 Pin 3 - Input

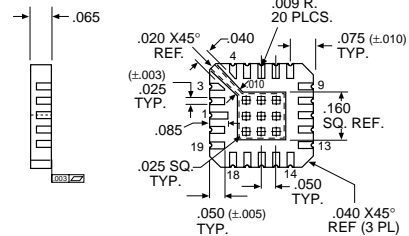
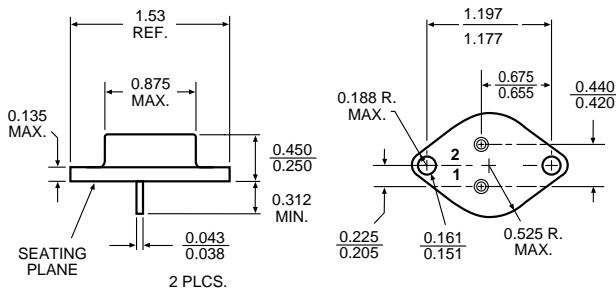

OM1327N2M

OM1327NKM
 Pin 1 - Adjust
 Pin 2 - Output
 Case - Input

Pin 1	V _{IN}	Pin 11	NC
Pin 2	NC	Pin 12	V _{OUT}
Pin 3	NC	Pin 13	V _{OUT}
Pin 4	NC	Pin 14	NC
Pin 5	NC	Pin 15	NC
Pin 6	NC	Pin 16	NC
Pin 7	NC	Pin 17	NC
Pin 8	NC	Pin 18	NC
Pin 9	ADJUST	Pin 19	NC
Pin 10	NC	Pin 20	V _{IN}

For additional information please see the mechanical outline section.

