

20A FAST RECOVERY RECTIFIERS

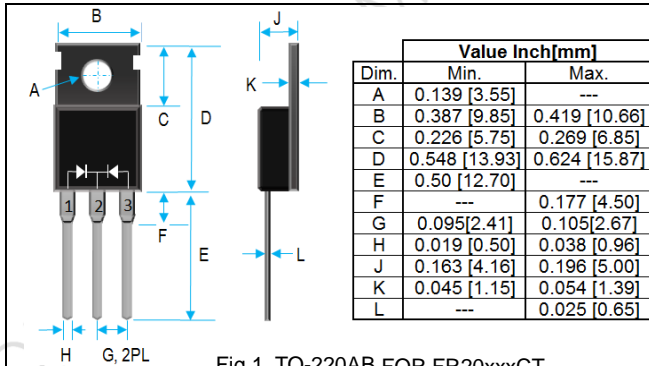

Fig 1. TO-220AB FOR FR20xxxCT

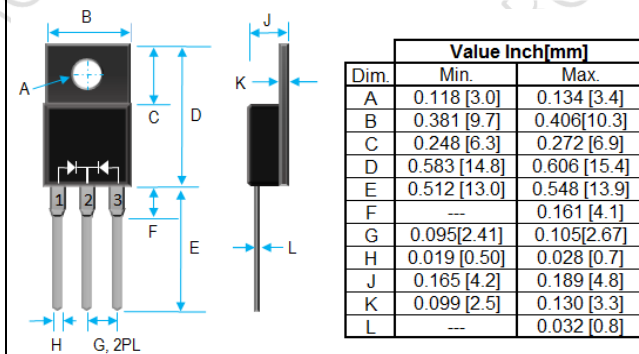

Fig 2. ITO-220AB FOR FR20xxxFCT

PRODUCT FEATURES

1. FLAMMABILITY CLASSIFICATION 94V-0
2. LOW FORWARD VOLTAGE V_F
3. FAST RECOVERY TIME
4. LOW THERMAL RESISTANCE/HIGH VOLTAGE
5. GLASS PASSIVATED CHIP JUNCTION
6. CASE: TRANSFER MOLDED
TO-220AB FOR FR2005CT THRU FR20100CT
ITO-220AB FOR FR2005FCT THRU FR20100FCT
7. DIMENSIONS IN INCHES AND (MILLIMETERS)
8. LEADS: SOLDERABILITY PER MIL-STD-202 METHOD 208
9. WEIGHT: 2.1 GRAMS (TO-220AB)
1.7 GRAMS (ITO-220AB)
10. RoHS COMPLIANT/HALOGEN FREE

ELECTRICAL CHARACTERISTICS

MAXIMUM RATINGS ($T_A = 25^\circ\text{C}$ UNLESS OTHERWISE NOTED) AND ELECTRICAL CHARACTERISTICS

RATING	SYMBOL	UNITS
MAXIMUM AVERAGE FORWARD RECTIFIED CURRENT, SEE FIG.1	I_o	20 (PER DEVICE) A
PEAK FORWARD SURGE CURRENT, 8.3ms SINGLE HALF SINE-WAVE SUPERIMPOSED ON RATED LOAD	I_{FSM}	175 A
TYPICAL JUNCTION CAPACITANCE @ 1MHz & REVERSE VOLTAGE 4V	C_J	55 pF
TYPICAL THERMAL RESISTANCE, JUNCTION TO CASE ON HEAT SINK	$R_{\theta jc}$	2.2 (PER LEG) $^\circ\text{C/W}$
STORAGE TEMPERATURE RANGE	T_{STG}	- 55 TO +175 $^\circ\text{C}$
OPERATING TEMPERATURE RANGE	T_{OP}	- 55 TO +150 $^\circ\text{C}$
MAXIMUM FORWARD VOLTAGE AT 10A PER LEG	V_F	1.3 V
MAXIMUM REVERSE CURRENT AT 25 $^\circ\text{C}$	I_R	10 μA
MAXIMUM REVERSE CURRENT AT 125 $^\circ\text{C}$	I_R	500 μA

PART NUMBER	MAX RECURRENT PK REVERSE VOLTAGE/DC BLOCKING V_{RRM}/V_R (V)	MAX V_{RMS} (V)	MAX REVERSE RECOVERY TIME T_{RR} (nS)	MARKING
FR2005CT/FR2005FCT	50	35	150	SAME AS P/N
FR2010CT/FR2010FCT	100	70	150	SAME AS P/N
FR2020CT/FR2020FCT	200	140	150	SAME AS P/N
FR2040CT/FR2040FCT	400	280	150	SAME AS P/N
FR2060CT/FR2060FCT	600	420	250	SAME AS P/N
FR2080CT/FR2080FCT	800	560	500	SAME AS P/N
FR20100CT/FR20100FCT	1000	700	500	SAME AS P/N

NOTE : 1. REVERSE RECOVERY TEST CONDITIONS: $I_F=0.5A$, $I_R=1.0A$, $I_{RR}=0.25A$.

2. CURRENT RATING IS BASED ON SINGLE PHASE, 1/2 WAVE, 60HZ, RESISTIVE, OR INDUCTIVE LOAD. FOR CAPACITIVE LOAD, DERATE CURRENT BY 20%

RATINGS AND CHARACTERISTIC CURVES

FIG. 1 - TEST CIRCUIT DIAGRAM AND REVERSE RECOVERY TIME CHARACTERISTIC

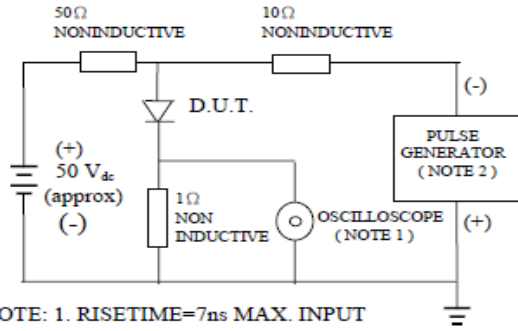

NOTE: 1. RISE TIME = 7 ns MAX. INPUT IMPEDANCE = 1 MEGOHM 22PF
 2. RISE TIME = 10 ns MAX. SOURCE IMPEDANCE = 50 OHMS

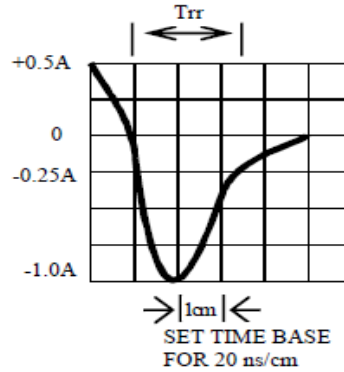

FIG. 2 - TYPICAL FORWARD CURRENT DERATING CURVE

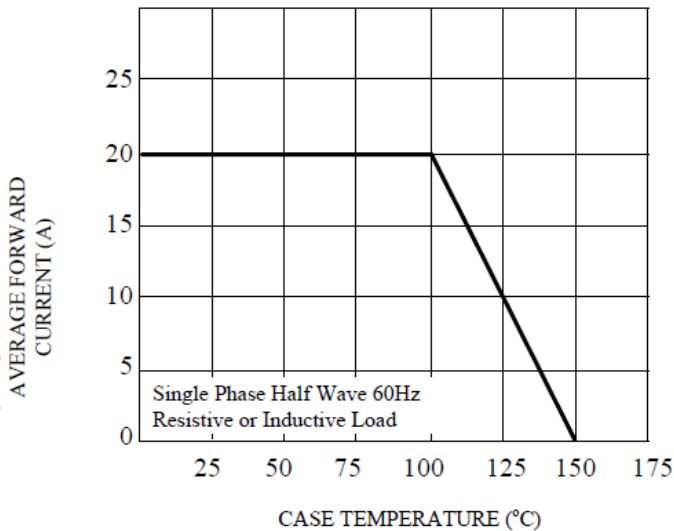

FIG. 3 - TYPICAL INSTANTANEOUS FORWARD CHARACTERISTICS

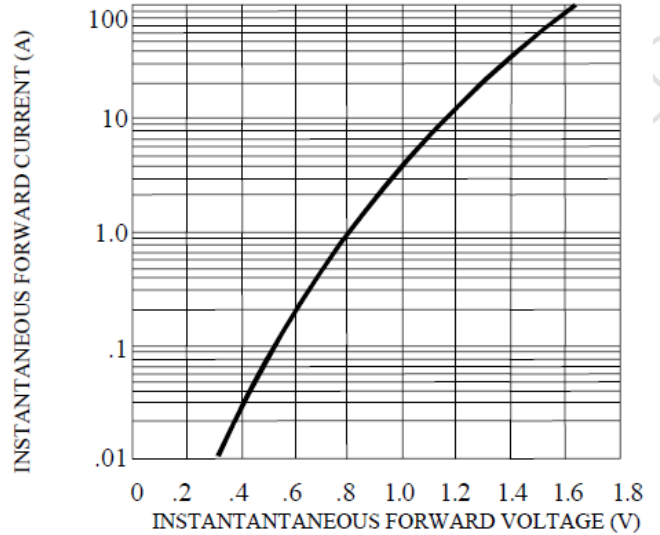

FIG. 4 - TYPICAL REVERSE CHARACTERISTICS

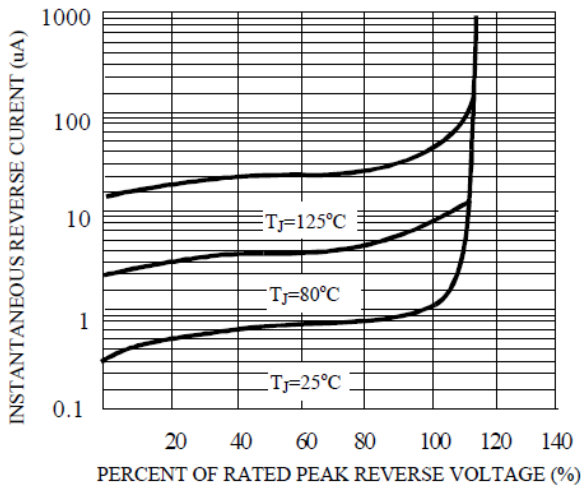

FIG. 5 - TYPICAL JUNCTION CAPACITANCE

