



# GRTB18-P2412

GR18

PHOTOELECTRIC SENSORS

**SICK**  
Sensor Intelligence.



Illustration may differ



### Ordering information

Type	Part no.
GRTB18-P2412	1076117

Other models and accessories → [www.sick.com/GR18](http://www.sick.com/GR18)

### Detailed technical data

#### Features

<b>Sensor/ detection principle</b>	Photoelectric proximity sensor, Background suppression
<b>Housing design (light emission)</b>	Cylindrical, straight
<b>Thread diameter (housing)</b>	M18 x 1
<b>Optical axis</b>	Axial
<b>Sensing range max.</b>	3 mm ... 300 mm <sup>1)</sup>
<b>Sensing range</b>	20 mm ... 150 mm <sup>1)</sup>
<b>Type of light</b>	Visible red light
<b>Light source</b>	PinPoint LED <sup>2)</sup>
<b>Light spot size (distance)</b>	Ø 7 mm (100 mm)
<b>Wave length</b>	650 nm
<b>Adjustment</b>	PotentiometerPotentiometer

<sup>1)</sup> Object with 90 % reflectance (referred to standard white, DIN 5033).

<sup>2)</sup> Average service life: 100,000 h at T<sub>U</sub> = +25 °C.

#### Communication interface

<b>Communication interface</b>	-
--------------------------------	---

## Mechanics/electronics

<b>Supply voltage</b>	10 V DC ... 30 V DC <sup>1)</sup>
<b>Ripple</b>	$\pm 5 V_{pp}$ <sup>2)</sup>
<b>Power consumption</b>	$\leq 30$ mA
<b>Output type</b>	PNP
<b>Output function</b>	Complementary
<b>Switching mode</b>	Light/dark switching
<b>Signal voltage PNP HIGH/LOW</b>	$V_S - (\leq 3 V) / \text{approx. } 0 V$
<b>Output current <math>I_{max}</math></b>	100 mA <sup>3)</sup>
<b>Response time</b>	$< 500 \mu s$ <sup>4)</sup>
<b>Switching frequency</b>	1,000 Hz <sup>5)</sup>
<b>Connection type</b>	Male connector M12, 4-pin
<b>Circuit protection</b>	A <sup>6)</sup> B <sup>7)</sup> D <sup>8)</sup>
<b>Protection class</b>	III
<b>Housing material</b>	Metal, Nickel-plated brass and ABS
<b>Optics material</b>	Plastic, PMMA
<b>Enclosure rating</b>	IP67
<b>Items supplied</b>	Fastening nuts (2 x)
<b>EMC</b>	EN 60947-5-2
<b>Ambient operating temperature</b>	$-25 \text{ }^\circ\text{C} \dots +55 \text{ }^\circ\text{C}$ <sup>9)</sup>
<b>Ambient storage temperature</b>	$-40 \text{ }^\circ\text{C} \dots +70 \text{ }^\circ\text{C}$
<b>UL File No.</b>	E348498

<sup>1)</sup> Limit values when operated in short-circuit protected network: max. 8 A.

<sup>2)</sup> May not exceed or fall below  $U_V$  tolerances.

<sup>3)</sup> At  $U_V > 24 V$  or ambient temperature  $> 49 \text{ }^\circ\text{C}$ ,  $I_A \text{ max.} = 50 \text{ mA}$ .

<sup>4)</sup> Signal transit time with resistive load.

<sup>5)</sup> With light/dark ratio 1:1.

<sup>6)</sup> A =  $V_S$  connections reverse-polarity protected.

<sup>7)</sup> B = inputs and output reverse-polarity protected.

<sup>8)</sup> D = outputs overcurrent and short-circuit protected.

<sup>9)</sup> At  $U_V \leq 24V$  and  $I_A < 50mA$ .

## Classifications

<b>ECl@ss 5.0</b>	27270904
<b>ECl@ss 5.1.4</b>	27270904
<b>ECl@ss 6.0</b>	27270904
<b>ECl@ss 6.2</b>	27270904
<b>ECl@ss 7.0</b>	27270904
<b>ECl@ss 8.0</b>	27270904
<b>ECl@ss 8.1</b>	27270904
<b>ECl@ss 9.0</b>	27270904
<b>ETIM 5.0</b>	EC002719

<b>ETIM 6.0</b>	EC002719
<b>UNSPSC 16.0901</b>	39121528

### Adjustments possible

GRTB18(S), GRTE18(S), Sensing rang setting: Potentiometer, 270°

Sensing range

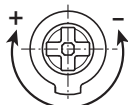

### Connection diagram

Cd-084

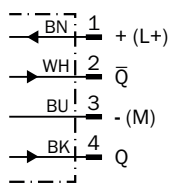

### Characteristic curve

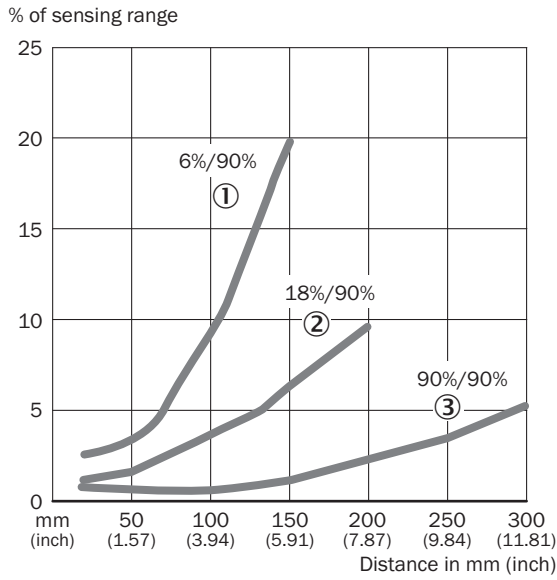

- ① Sensing range on black, 6% remission
- ② Sensing range on gray, 18 % remission
- ③ Sensing range on white, 90% remission

### Light spot size

GRTB18(S)

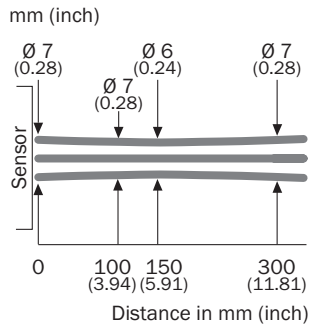

### Sensing range diagram

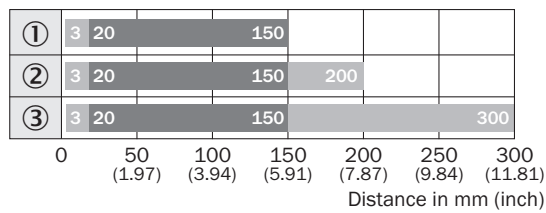

■ Sensing range    ■ Sensing range max.

- ① Sensing range on black, 6% remission
- ② Sensing range on gray, 18 % remission
- ③ Sensing range on white, 90% remission

### Dimensional drawing (Dimensions in mm (inch))

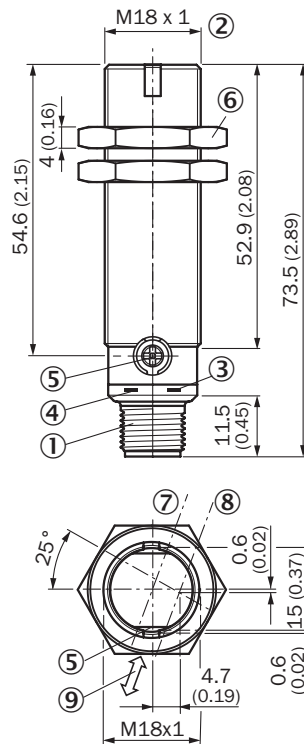

GRTB18, metal, connector, straight







- ① Male connector M12, 4-pin
- ② Threaded mounting hole M18 x 1
- ③ LED indicator yellow
- ④ LED indicator green
- ⑤ Sensitivity control: potentiometer 270°
- ⑥ Fastening nuts (2x); width across 24, metal
- ⑦ Optical axis receiver
- ⑧ Optical axis sender
- ⑨ Standard direction of the material being detected

### Recommended accessories

Other models and accessories → [www.sick.com/GR18](http://www.sick.com/GR18)

	Brief description	Type	Part no.
<b>Universal bar clamp systems</b>			
	Plate N06 for universal clamp bracket, M18, Zinc plated steel (sheet), Zinc die cast (clamping bracket), Universal clamp (5322626), mounting hardware	BEF-KHS-N06	2051612
<b>Mounting brackets and plates</b>			
	Mounting plate for M18 sensors, steel, zinc coated, without mounting hardware	BEF-WG-M18	5321870
	Mounting bracket for M18 sensors, steel, zinc coated, without mounting hardware	BEF-WN-M18	5308446

	Brief description	Type	Part no.
Terminal and alignment brackets			
	Mounting bracket with ball-and-socket, Plastic, mounting hardware included	BEF-WN-M18-ST02	5312973
	Clamping block for round sensors M18, without fixed stop, plastic (PA12), glass-fiber reinforced, mounting hardware included	BEF-KH-M18	2051481
	Clamping block for round sensors M18, with fixed stop, plastic (PA12), glass-fiber reinforced, mounting hardware included	BEF-KHF-M18	2051482
	Integrated adapter, Plastic (PA12)	BEF-WN-MH15-1	4039533
	Mounting ring, Stainless steel, without mounting hardware	BEF-WN-MH15-2V	4053358

## SICK AT A GLANCE

SICK is one of the leading manufacturers of intelligent sensors and sensor solutions for industrial applications. A unique range of products and services creates the perfect basis for controlling processes securely and efficiently, protecting individuals from accidents and preventing damage to the environment.

We have extensive experience in a wide range of industries and understand their processes and requirements. With intelligent sensors, we can deliver exactly what our customers need. In application centers in Europe, Asia and North America, system solutions are tested and optimized in accordance with customer specifications. All this makes us a reliable supplier and development partner.

Comprehensive services complete our offering: SICK LifeTime Services provide support throughout the machine life cycle and ensure safety and productivity.

For us, that is “Sensor Intelligence.”

## WORLDWIDE PRESENCE:

Contacts and other locations –[www.sick.com](http://www.sick.com)