

1. PART NO. EXPRESSION :

P I C 1 2 0 6 H P 3 3 0 M F - □ □
 (a) (b) (c) (d) (e)(f) (g)

- (a) Series code
- (b) Dimension code
- (c) Type code

- (d) Inductance code : 330 = 33.0uH
- (e) Tolerance code : M = ±20%, Y = ±30%
- (f) F : RoHS Compliant
- (g) 11~99 : Internal controlled number

2. CONFIGURATION & DIMENSIONS :

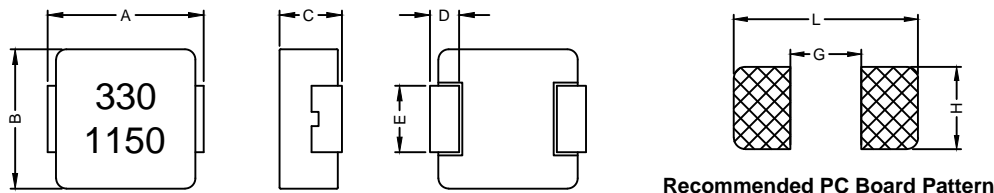

Unit:m/m

A	B	C	D	E	G	H	L
13.5±0.5	12.5±0.3	5.7±0.3	2.3±0.3	4.7±0.3	8.0	5.0	14.2

3. SCHEMATIC :

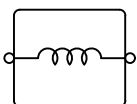

4. MATERIALS :

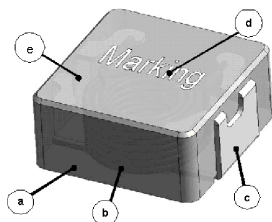

- (a) Core
- (b) Wire
- (c) Terminal
- (d) Ink
- (e) Paint

5. GENERAL SPECIFICATION :

- a) Test Freq. : L : 100KHz/1.0V
- b) Operating Temp. : -40°C to +125°C
- c) Storage Temp. : -40°C to +125°C
- d) Humidity Range : 85 ± 3% RH
- e) Heat Rated Current (I_{rms}) will cause the coil temperature rise approximately Δt of 40°C (keep 1min)
- f) Saturation Current (I_{sat}) will cause L₀ to drop 20%.
- g) Part Temperature (Ambient+Temp. Rise) : Should not exceed 125°C under worst case operating conditions.
- h) Storage condition (component in its packaging)
 - i) Temperature: -10 to 40°C
 - ii) Humidity : 50~60% RH



RoHS Compliant

NOTE : Specifications subject to change without notice. Please check our website for latest information.

06.11.2015

6. ELECTRICAL CHARACTERISTICS :

Part No.	Inductance L ₀ (μ H) @ 0 A	I _{rms} (A) Typ.	I _{sat} (A) Typ.	DCR (m Ω) Typ. @ 25°C	DCR (m Ω) Max. @ 25°C
PIC1206HPR47MF	0.47	38	60	0.92	1.3
PIC1206HPR56MF	0.56	35	56	1.15	1.5
PIC1206HPR68MF	0.68	33	53	1.33	1.7
PIC1206HP1R0MF	1.00	29	45	1.8	2.4
PIC1206HP1R2MF	1.20	28	44	2.1	2.8
PIC1206HP1R5MF	1.50	26	43	2.7	3.2
PIC1206HP2R2MF	2.20	21	34	4.0	4.7
PIC1206HP2R7MF	2.70	19	31	4.6	5.4
PIC1206HP3R3MF	3.30	17	28	5.8	7.1
PIC1206HP4R7MF	4.70	16	25	9.5	11.5
PIC1206HP5R6MF	5.60	15.5	22	10.8	12.6
PIC1206HP6R8MF	6.80	15	19	12	13.8
PIC1206HP8R2MF	8.20	11	17	13.6	16
PIC1206HP100MF	10.0	11	15.5	18	20.7
PIC1206HP120MF	12.0	9.5	13.5	20	23
PIC1206HP150MF	15.0	9.0	13	25	29
PIC1206HP180MF	18.0	8.5	12	30	35
PIC1206HP220MF	22.0	8.0	11	34	39.5
PIC1206HP270MF	27.0	7.0	9.0	49	56
PIC1206HP330MF	33.0	6.0	8.0	65	75
PIC1206HP470MF	47.0	5.5	7.0	80	90
PIC1206HP560MF	56.0	5.3	6.5	101	118
PIC1206HP680MF	68.0	5.0	6.0	120	140
PIC1206HP820MF	82.0	4.5	5.5	138	161
PIC1206HP101MF	100	4.0	5.0	180	200
PIC1206HP121MF	120	3.5	4.5	210	235
PIC1206HP151MF	150	3.0	4.0	300	350

Tolerance code : M = \pm 20%, Y = \pm 30%



RoHS Compliant

NOTE : Specifications subject to change without notice. Please check our website for latest information.

06.11.2015

7. CHARACTERISTICS CURVES :

PIC1206HPR47MF

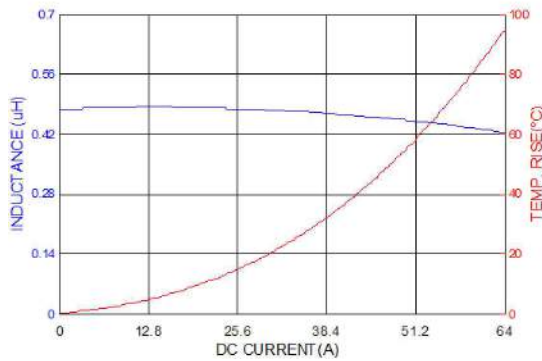

PIC1206HPR56MF

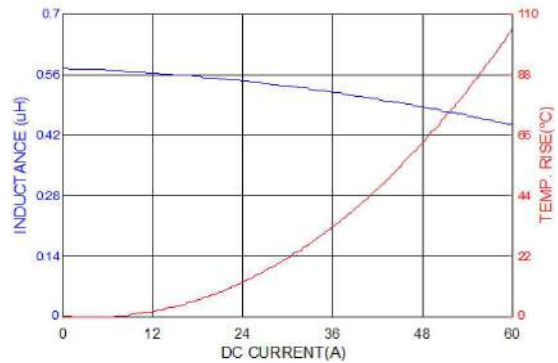

PIC1206HPR68MF

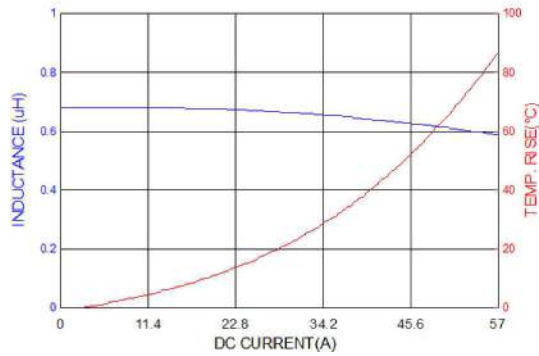

PIC1206HP1R0MF

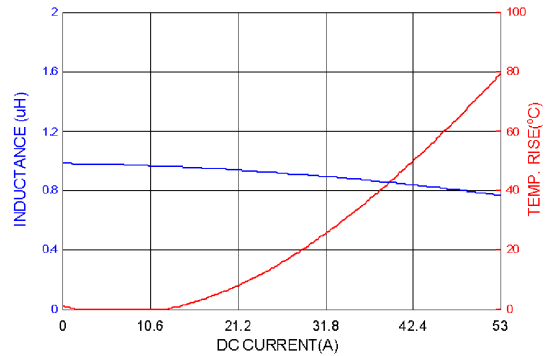

PIC1206HP1R2MF

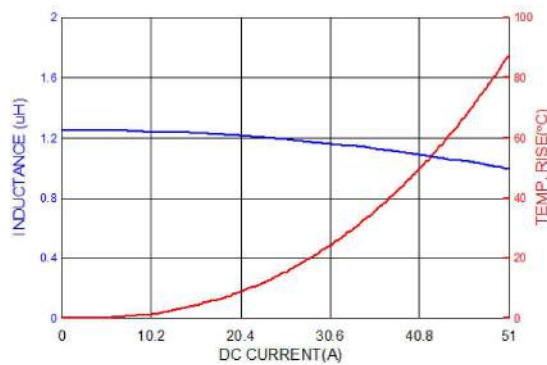

PIC1206HP1R5MF

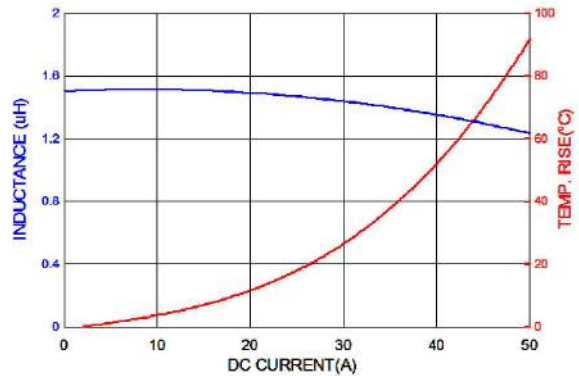

RoHS Compliant

NOTE : Specifications subject to change without notice. Please check our website for latest information.

06.11.2015



SUPERWORLD ELECTRONICS (S) PTE LTD

7. CHARACTERISTICS CURVES :

PIC1206HP2R2MF

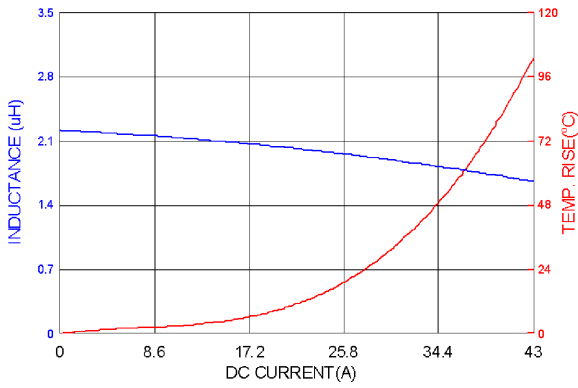

PIC1206HP2R7MF

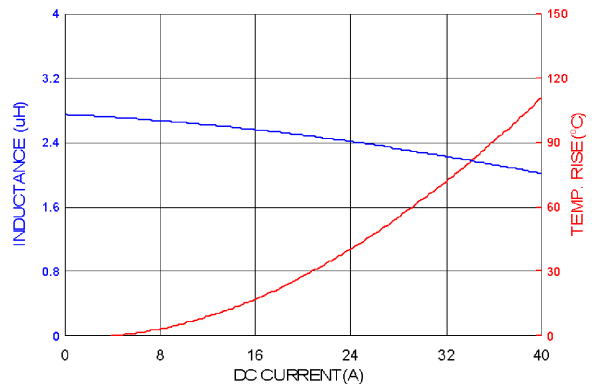

PIC1206HP3R3MF

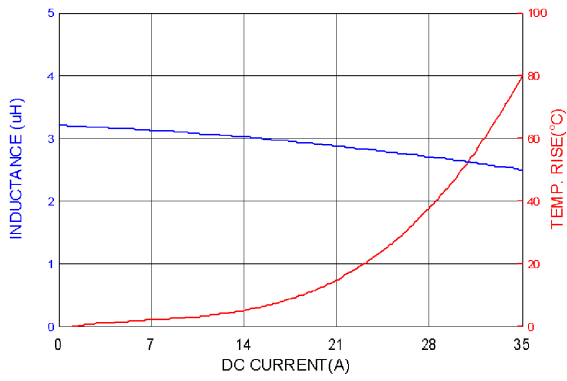

PIC1206HP4R7MF

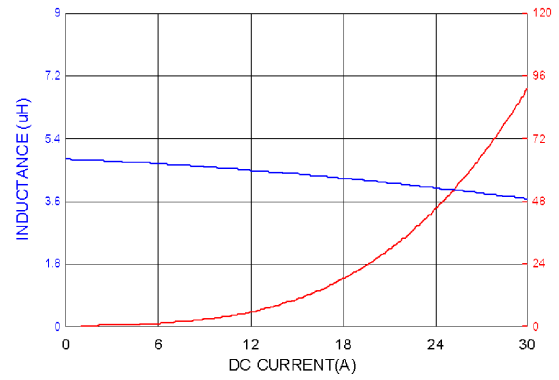

PIC1206HP5R6MF

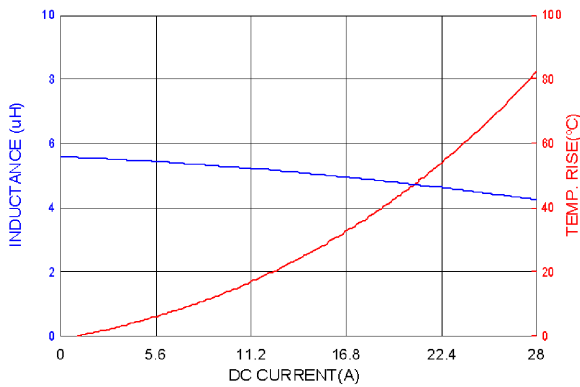

PIC1206HP6R8MF

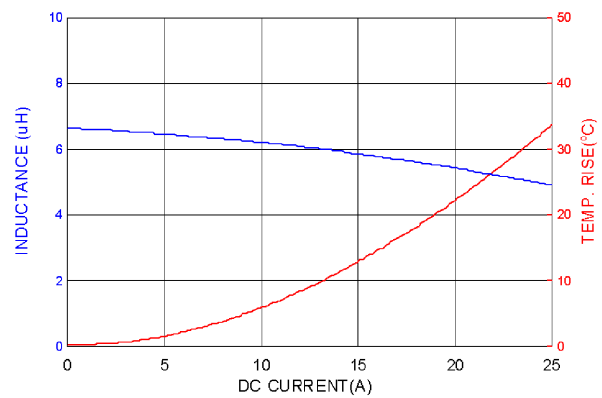

RoHS Compliant

NOTE : Specifications subject to change without notice. Please check our website for latest information.



SUPERWORLD ELECTRONICS (S) PTE LTD

06.11.2015

7. CHARACTERISTICS CURVES :

PIC1206HP8R2MF

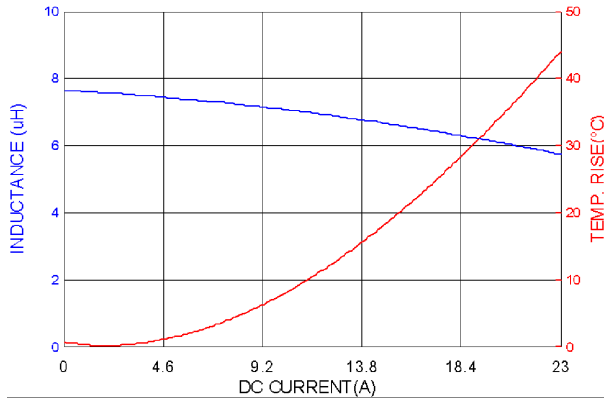

PIC1206HP100MF

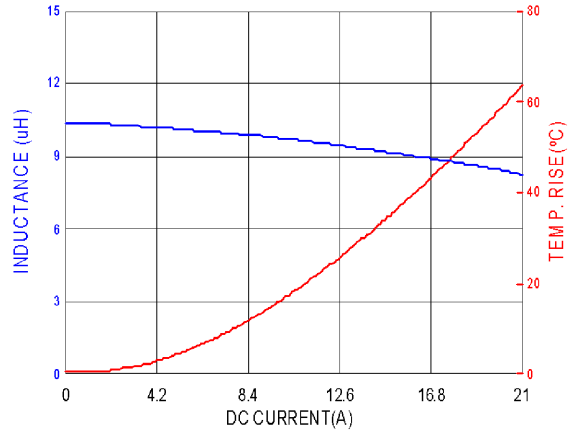

PIC1206HP120MF

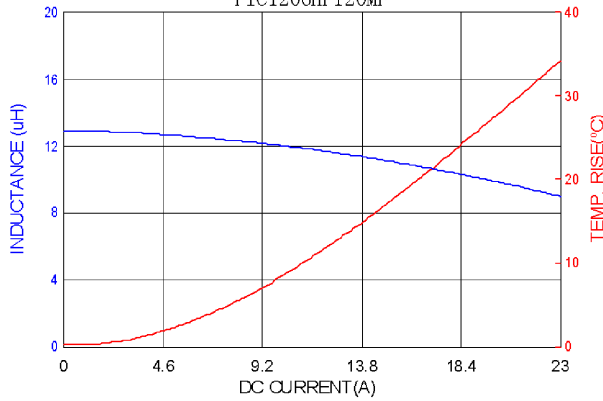

PIC1206HP150MF

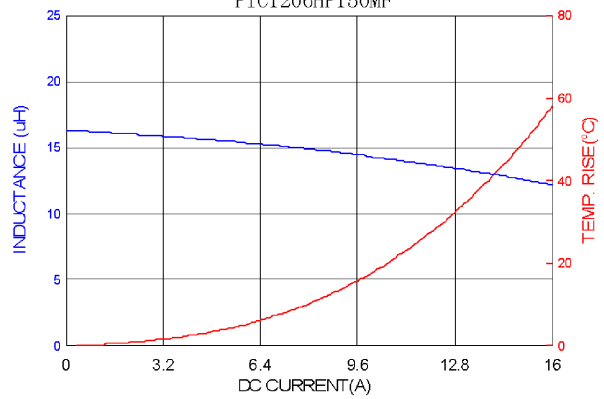

PIC1206HP180MF

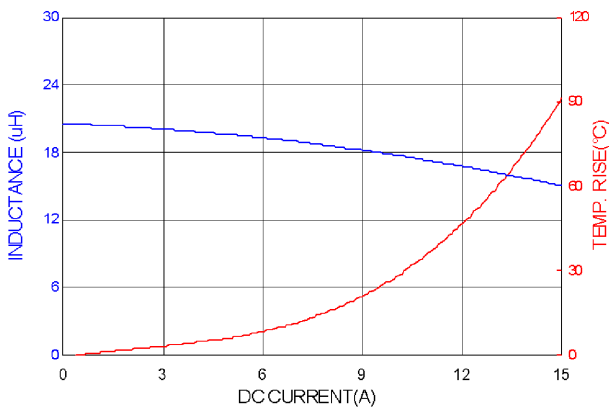

PIC1206HP220MF

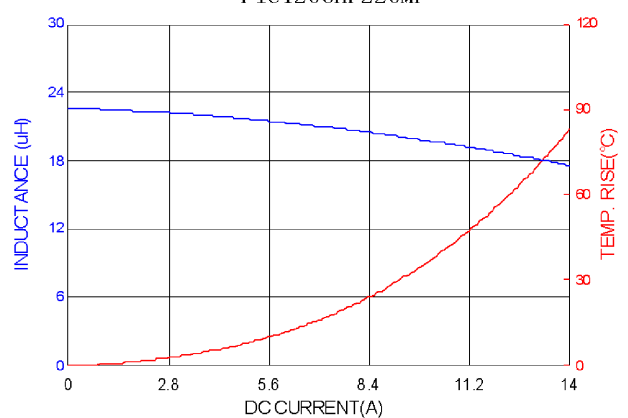

RoHS Compliant

NOTE : Specifications subject to change without notice. Please check our website for latest information.

06.11.2015



SUPERWORLD ELECTRONICS (S) PTE LTD

7. CHARACTERISTICS CURVES :

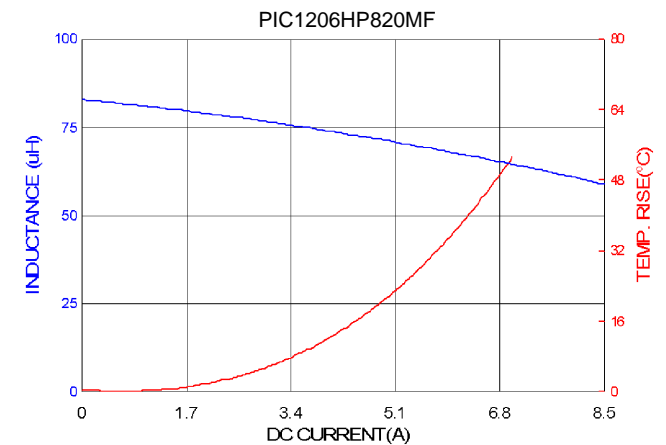
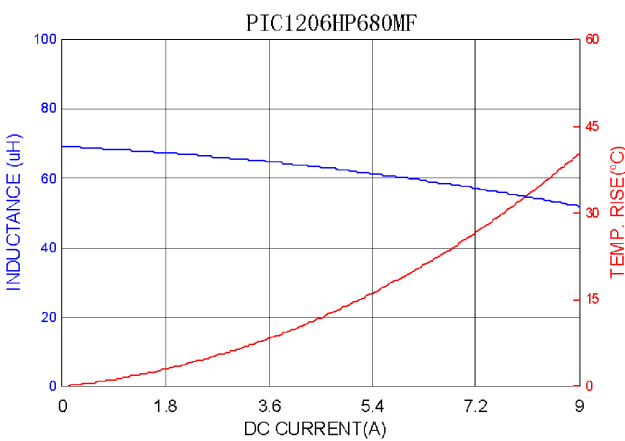
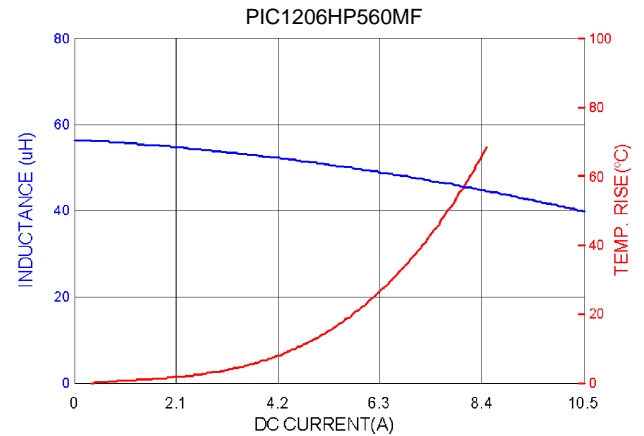
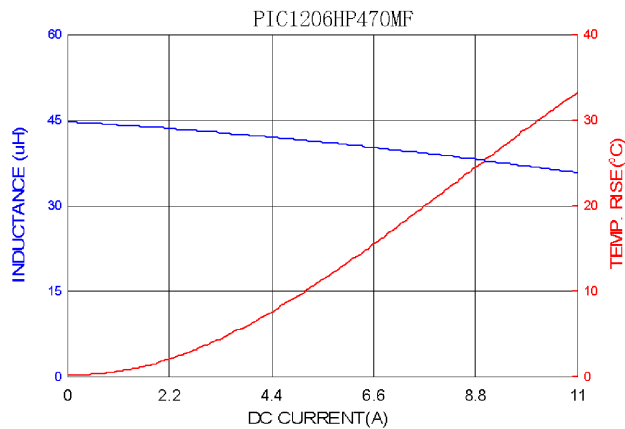
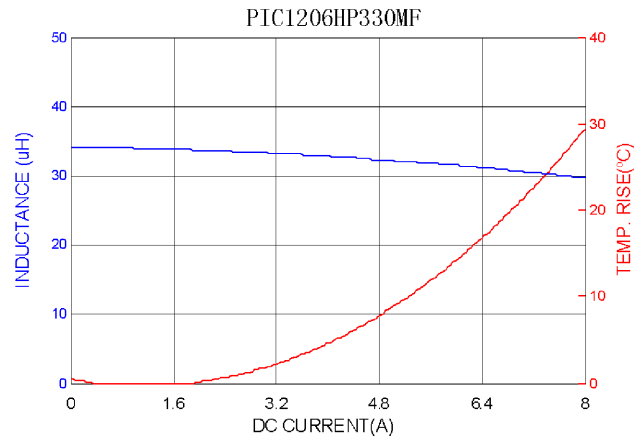
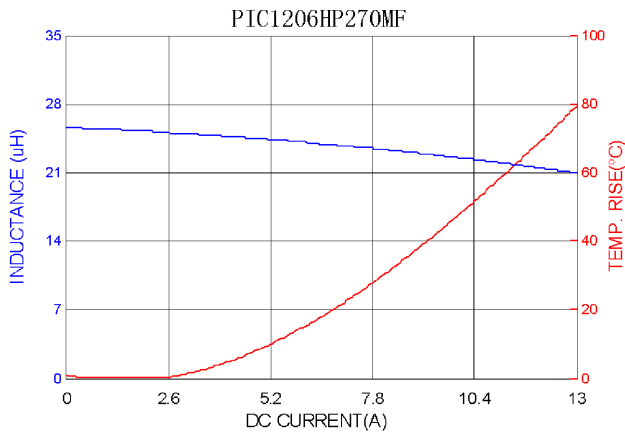

NOTE : Specifications subject to change without notice. Please check our website for latest information.

06.11.2015



7. CHARACTERISTICS CURVES :

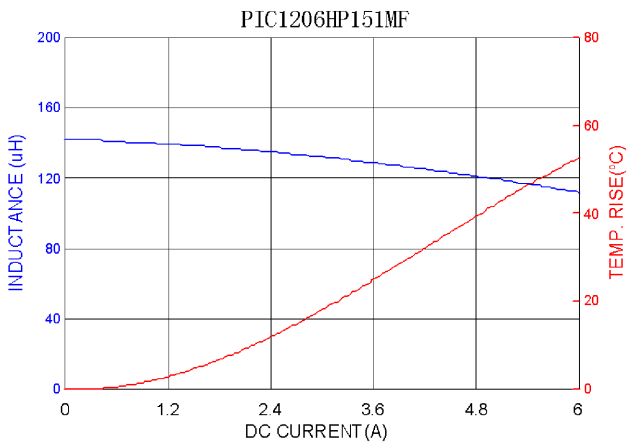
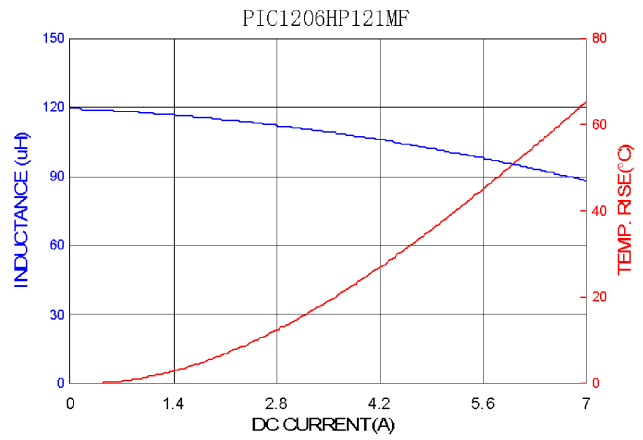
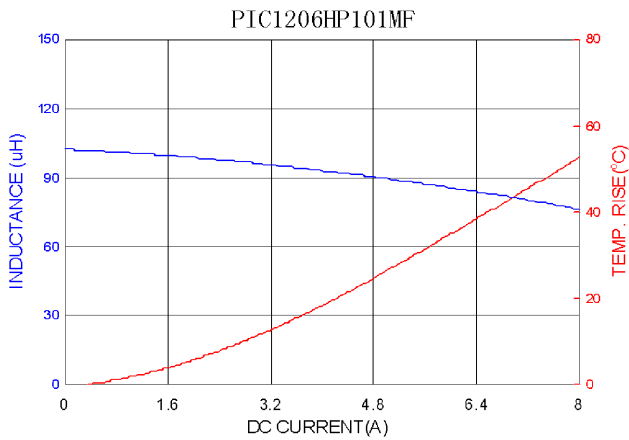

RoHS Compliant

NOTE : Specifications subject to change without notice. Please check our website for latest information.

06.11.2015

8. SOLDERING

Mildly activated rosin fluxes are preferred. The minimum amount of solder can lead to damage from the stresses caused by the difference in coefficients of expansion between solder, chip and substrate. Our terminations are suitable for all re-flow soldering systems. If hand soldering cannot be avoided, the preferred technique is the utilization of hot air soldering tools.

8-1.1 Solder Re-flow :

Recommended temperature profiles for re-flow soldering in Figure 1.

8-1.2 Soldering Iron (Figure 2) :

Products attachment with soldering iron is discouraged due to the inherent process control limitations. In the event that a soldering iron must be employed the following precautions are recommended.

Note :

- a) Preheat circuit and products to 150°C.
- b) 355°C tip temperature (max)
- c) Never contact the ceramic with the iron tip
- d) 1.0mm tip diameter (max)
- e) Use a 20 watt soldering iron with tip diameter of 1.0mm
- f) Limit soldering time to 4~5 secs.

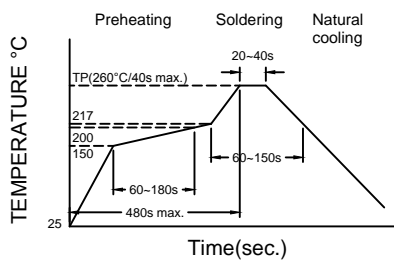

Figure 1. Re-flow Soldering: 3 times max.

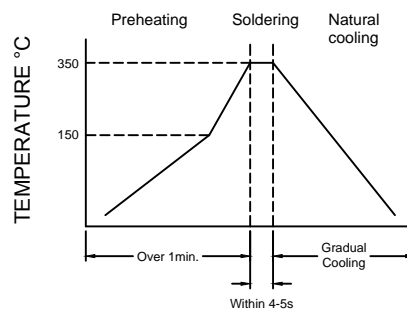

Figure 2. Hand Soldering: 1 times max.



RoHS Compliant

NOTE : Specifications subject to change without notice. Please check our website for latest information.

06.11.2015



SUPERWORLD ELECTRONICS (S) PTE LTD

9. PACKAGING INFORMATION :

9-1. Reel Dimension

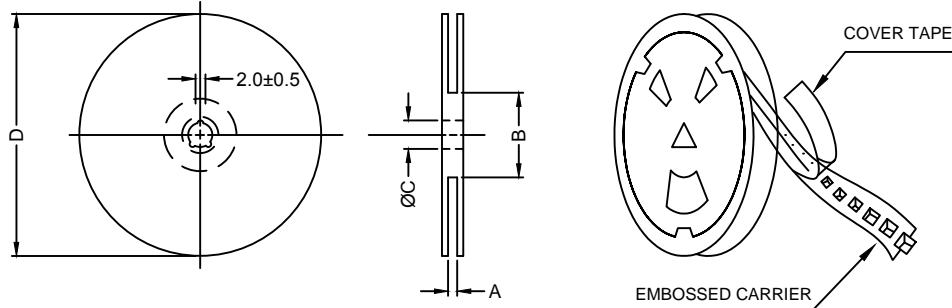

Type	A(mm)	B(mm)	C(mm)	D(mm)
13" x 24mm	24.4+2.0/-0	100±2	13.5±0.5	330

9-2. Tape Dimension

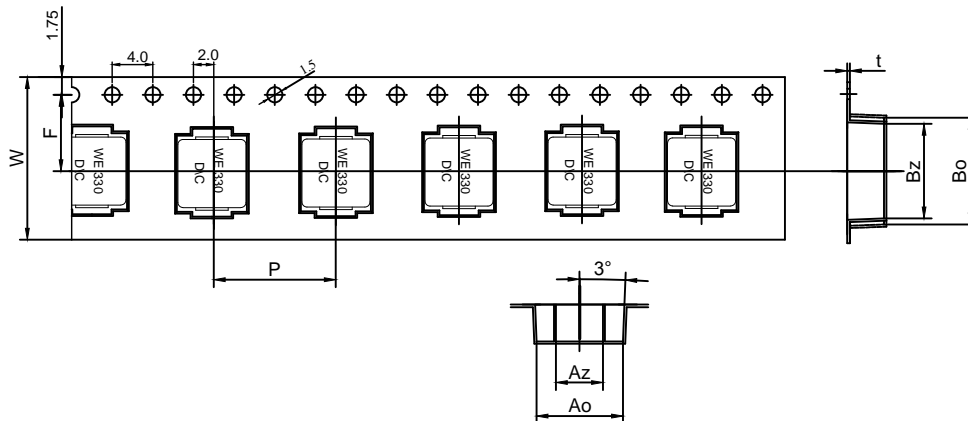

Series	Bo(mm)	Bz(mm)	Ao(mm)	Az(mm)	Ko(mm)	P(mm)	W(mm)	F(mm)	t(mm)
PIC1206	14.1±0.1	13.0±0.1	12.9±0.1	7.0±0.1	6.5±0.1	16.0±0.1	24±0.3	11.5±0.1	0.35±0.05

9-3. Packaging Quantity

Size	PIC1206
Chip / Reel	500
Inner Box	1000
Carton	4000



RoHS Compliant

NOTE : Specifications subject to change without notice. Please check our website for latest information.

06.11.2015

9-4. Tearing Off Force

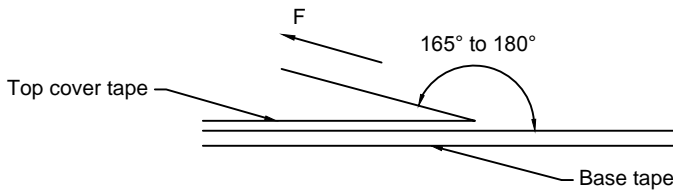

The force for tearing off cover tape is 10 to 130 grams in the arrow direction under the following conditions. (referenced ANSI/EIA-481-C-2003 of 4.11 standard)

Room Temp. (°C)	Room Humidity (%)	Room atm (hPa)	Tearing Speed (mm/min)
5~35	45~85	860~1060	300

Application Notice

1. Storage Conditions :

To maintain the solderability of terminal electrodes :

- a) Recommended products should be used within 12 months from the time of delivery.
- b) The packaging material should be kept where no chlorine or sulfur exists in the air.

2. Transportation :

- a) Products should be handled with care to avoid damage or contamination from perspiration and skin oils.
- b) Vacuum pick up is strongly recommended for individual components.
- c) Bulk handling should ensure that abrasion and mechanical shock are minimized.



RoHS Compliant

NOTE : Specifications subject to change without notice. Please check our website for latest information.

06.11.2015



SUPERWORLD ELECTRONICS (S) PTE LTD

PG.10