

# ASMT-MT00

## Moonstone® Tri-Color Power LED Light Source



### Data Sheet



Lead (Pb) Free  
RoHS 6 fully  
compliant



#### Description

The Moonstone® Tri-Color Power LED Light Source is a high performance energy efficient device which can handle high thermal and high driving current. The exposed pad design enables excellent heat transfer from the package to the motherboard.

The low profile package design is suitable for a wide variety of applications especially where height is a constraint.

The package is compatible with reflow soldering process. This will give more freedom and flexibility to the light source designer.

#### Applications

- Contour lighting
- Cove lighting
- Architectural lighting
- Garden lighting
- Decorative lighting
- Commercial lighting
- Mood lighting

#### Features

- Available in Tri-color.
- Energy efficient.
- Exposed pad for excellent heat transfer.
- Suitable for reflow soldering process.
- High current operation.
- Long operation life.
- Wide viewing angle.
- Silicone encapsulation.
- Non-ESD sensitive (threshold > 16KV).
- MSL 5a products.

#### Specifications

- 3.5 V (max) at 350 mA for InGaN
- 2.3 V (max) at 350 mA for AlInGaP
- 120° viewing angle

## Package Dimensions

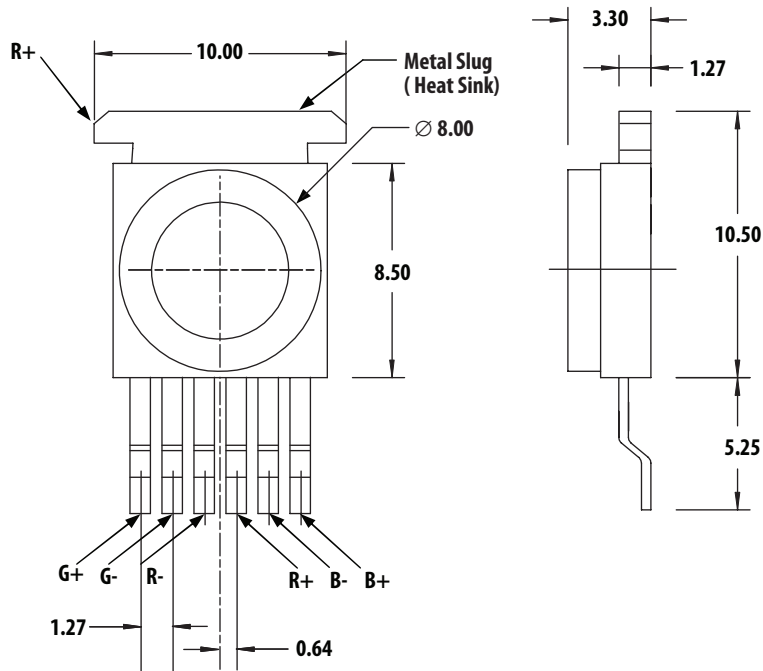

### Notes:

1. All dimensions in millimeters.
2. Tolerance is  $\pm 0.1$  mm unless otherwise specified.
3. Metal slug is connected to the anode of Red.

## Device Selection Guide ( $T_j = 25^\circ\text{C}$ )

Part Number	Color	Luminous Flux, $\Phi_V$ [1,2] (lm)			Test Current (mA)	Dice Technology
		Min.	Typ.	Max.		
ASMT-MT00	Red	33.0	40.0	56.0	350	AllInGaP
	Green	73.0	85.0	124.0		InGaN
	Blue	9.0	13.0	19.5		InGaN

### Notes:

1.  $\Phi_V$  is the total luminous flux output as measured with an integrating sphere at 25ms mono pulse condition.
2. Flux tolerance is  $\pm 10\%$ .

## Part Numbering System

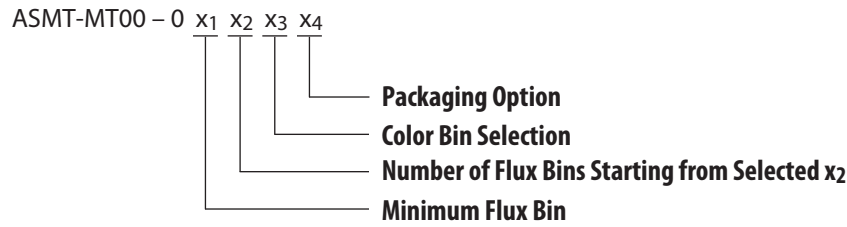

Note:

1. Please refer to Page 6 for selection details.

## Absolute Maximum Ratings

Parameter	AllnGaP	InGaN	Units
DC Forward Current <sup>[1]</sup>	350	350	mA
Peak Pulsing Current <sup>[2]</sup>	1000	1000	mA
Power Dissipation	805	1225	mW
LED Junction Temperature	125	125	°C
Operating Metal Slug Temperature Range at 350 mA	-40 to +105	-40 to +105	°C
Storage Temperature Range	-40 to +120	-40 to +120	°C
Soldering Temperature	Refer to Figure. 10		

Note:

1. Derate linearly based on Figure. 7 for InGaN and Figure. 8 for AllnGaP.
2. Pulse condition duty factor = 10 %, Frequency = 1 kHz.

## Optical Characteristics at 350 mA (T<sub>J</sub> = 25°C)

Part Number	Color	Peak Wavelength, $\lambda_{PEAK}$ (nm)	Dominant Wavelength, $\lambda_D$ <sup>[1]</sup> (nm)	Viewing Angle, $2\theta_{1/2}$ <sup>[2]</sup> (°)	Luminous Efficiency (lm/W)
		Typ.	Typ.	Typ.	Typ.
ASMT-MT00	Red	635	625	120	54
	Green	519	525	120	76
	Blue	454	460	120	12

Notes:

1. The dominant wavelength,  $\lambda_D$ , is derived from the CIE Chromaticity Diagram and represents the color of the device.
2.  $\theta_{1/2}$  is the off-axis angle where the luminous intensity is 1/2 the peak intensity.

## Electrical Characteristic at 350 mA (T<sub>J</sub> = 25°C)

Dice Type	Forward Voltage, V <sub>F</sub> (Volts) at I <sub>F</sub> = 350mA			Reverse Voltage, V <sub>R</sub> <sup>[1]</sup>	Thermal Resistance, R $\theta_{j-ms}$ (°C/W) <sup>[2]</sup>
	Min.	Typ.	Max.		Typ.
AllnGaP	1.7	2.1	2.3	Not recommended	23
InGaN	2.8	3.2	3.5		20

Notes:

1. Not designed for reverse bias operation.
2. R $\theta_{j-ms}$  is Thermal Resistance from LED junction to metal slug. All 3 colors are lighted up at once during measurement.

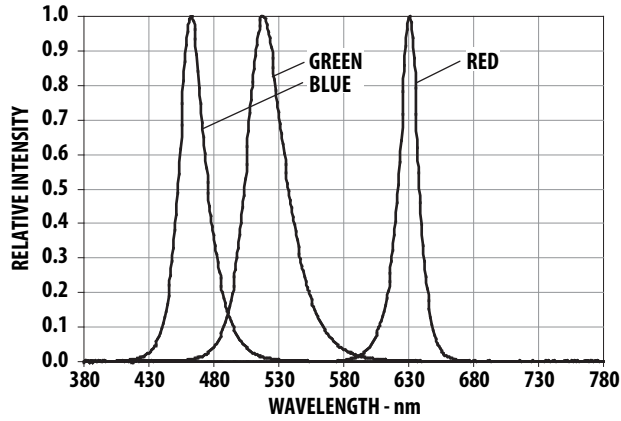

Figure 1. Relative Intensity vs. Wavelength.

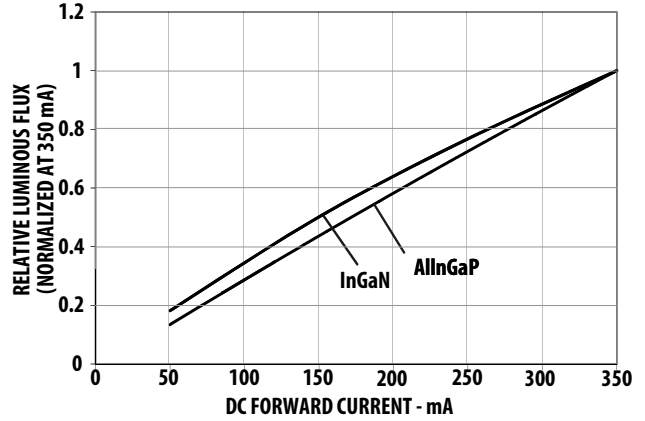

Figure 2. Relative Luminous Flux vs. Mono Pulse Current.

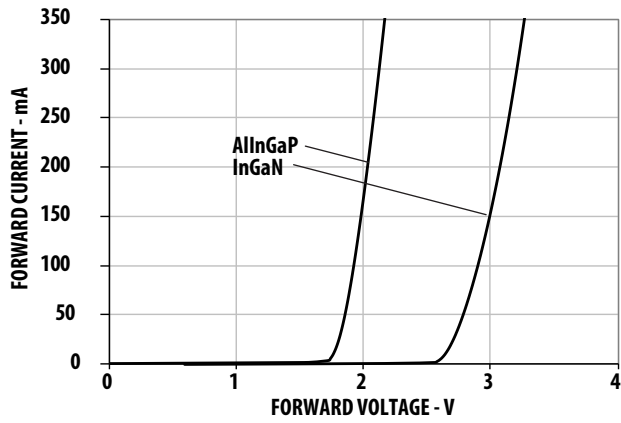

Figure 3. Forward Current vs. Forward Voltage.

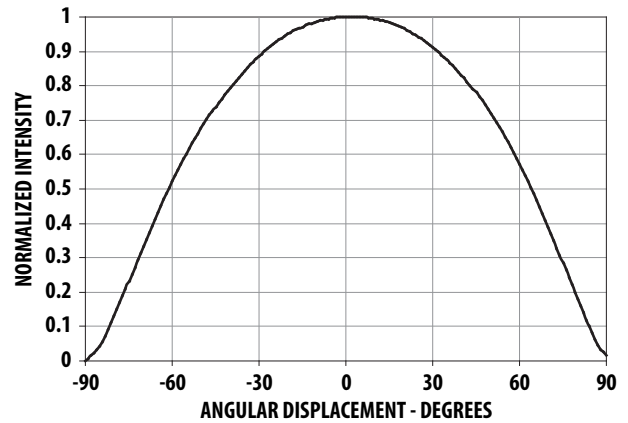

Figure 4. Radiation Pattern.

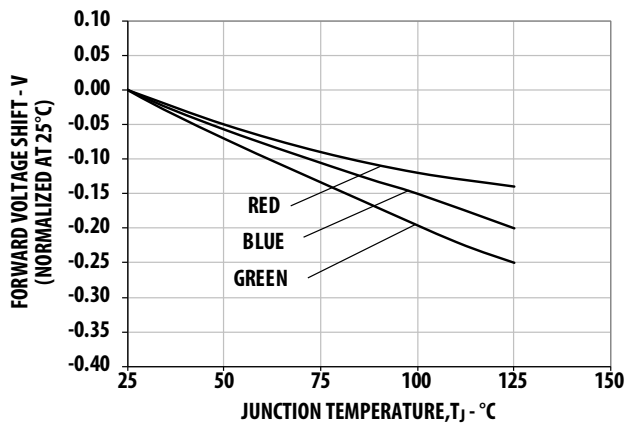

Figure 5. Forward Voltage Shift vs. Junction Temperature.

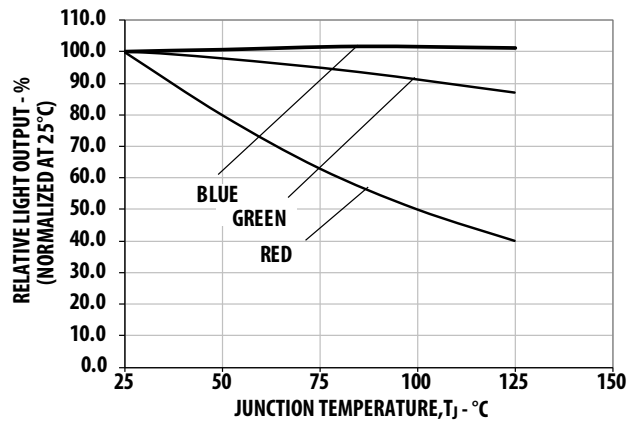

Figure 6. Relative Light Output vs. Junction Temperature.

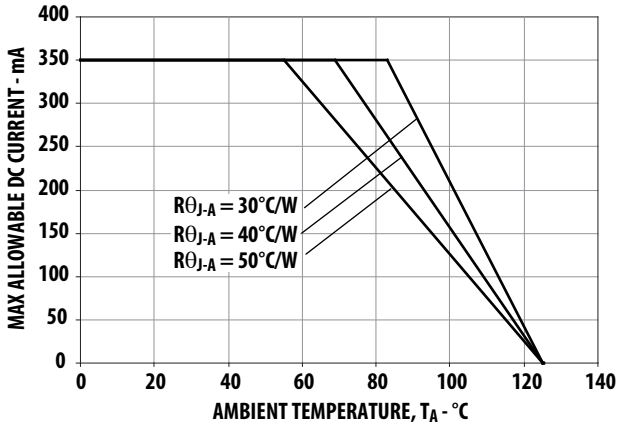

Figure 7. Maximum Forward Current vs. Ambient Temperature for InGaN. Derated based on  $T_{JMAX} = 125^{\circ}C$ ,  $R_{\theta J-A} = 30^{\circ}C/W$ ,  $40^{\circ}C/W$  and  $50^{\circ}C/W$ .

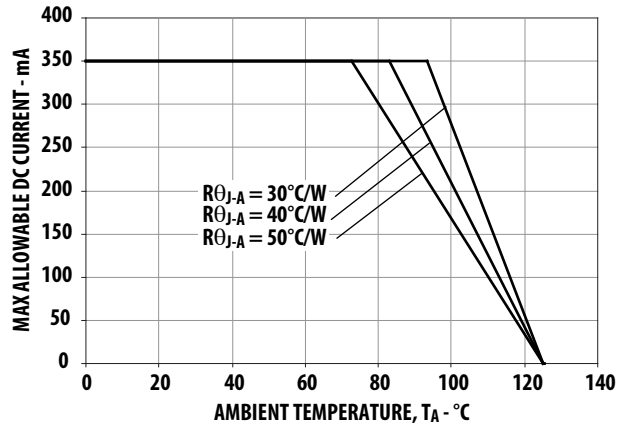

Figure 8. Maximum Forward Current vs. Ambient Temperature for AlInGaP. Derated based on  $T_{JMAX} = 125^{\circ}C$ ,  $R_{\theta J-A} = 30^{\circ}C/W$ ,  $40^{\circ}C/W$  and  $50^{\circ}C/W$ .

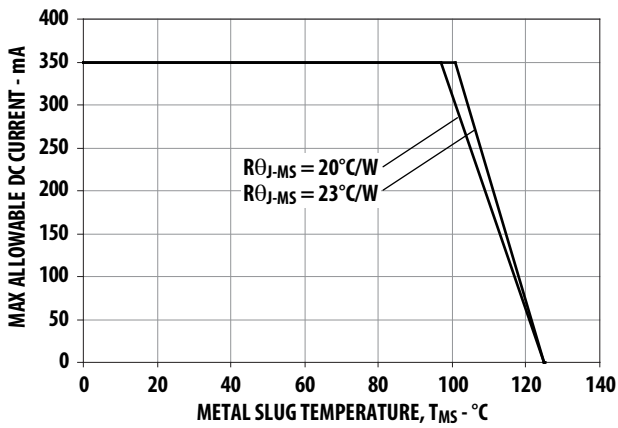

Figure 9. Maximum Forward Current vs. Metal Slug Temperature. Derated based on  $T_{JMAX} = 125^{\circ}C$ ,  $R_{\theta J-MS} = 20^{\circ}C/W$  for InGaN and  $R_{\theta J-MS} = 23^{\circ}C/W$  for AlInGaP.

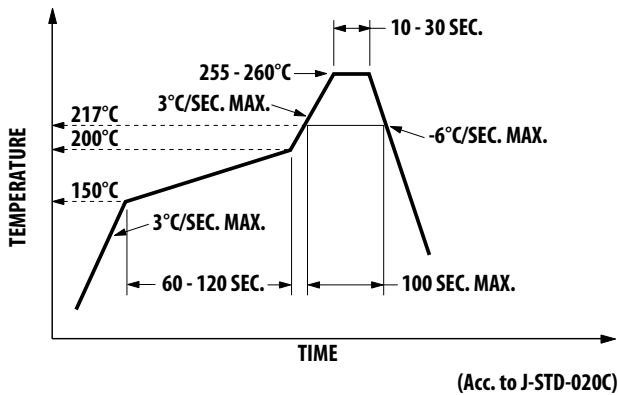

Figure 10. Recommended Reflow Soldering [1].

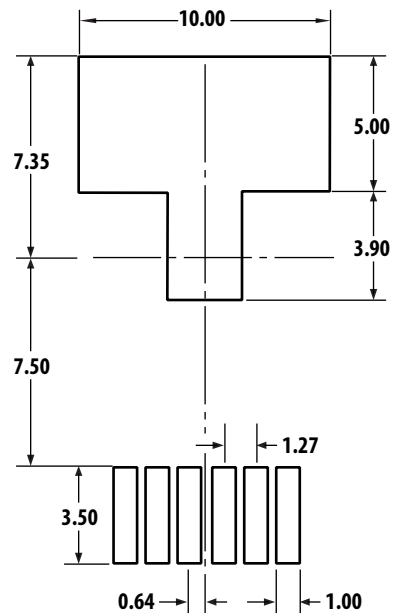

Figure 11. Recommended soldering land pattern.

Note:

For detail information on reflow soldering of Avago surface mount LEDs, do refer to Avago Application Note AN1060 Surface Mounting SMT LED Indicator Components.

## Option Selection Details

### ASMT-MT00 – 0 x<sub>1</sub> x<sub>2</sub> x<sub>3</sub> x<sub>4</sub>

x<sub>1</sub> – Minimum Flux Bin

x<sub>2</sub> – Number of Flux Bins Starting from Selected x<sub>1</sub>

x<sub>3</sub> – Color Bin Selection

x<sub>4</sub> – Packaging Option

### Flux Bin Selection [x<sub>1</sub>, x<sub>2</sub>]

Individual reel will contain part from 1 bin only.

x <sub>1</sub>	Minimum Flux Bin		
	Red	Green	Blue
0	Full Distribution		
A	H	J	C

x <sub>2</sub>	Number of Flux Bins Starting from Selected x <sub>1</sub>		
	Red	Green	Blue
0	Full Distribution		
A	2	2	2
B	2	2	3
D	2	3	3

### Color Bin Selection [x<sub>3</sub>]

Individual reel will contain part from 1 bin only.

x <sub>3</sub>	Color Bin Combination		
	Red	Green	Blue
0	Full Distribution	A, B, C and D	A, B, C and D

### Packaging Option [x<sub>4</sub>]

Selection	Option
1	Tape and Reel

### Flux Bin Limit

Bin ID	Luminous Flux (lm) at I <sub>F</sub> = 350 mA	
	Min.	Max.
A	5.5	7.0
B	7.0	9.0
C	9.0	11.5
D	11.5	15.0
E	15.0	19.5
F	19.5	25.5
G	25.5	33.0
H	33.0	43.0
J	43.0	56.0
K	56.0	73.0
L	73.0	95.0
M	95.0	124.0

Tolerance for each bin limits is ±10%

### Color Bin Limit

Color	Bin ID	Min.	Max.
Red	Full Distribution	620.0	635.0
Green	A	515.0	520.0
	B	520.0	525.0
	C	525.0	530.0
	D	530.0	535.0
Blue	A	455.0	460.0
	B	460.0	465.0
	C	465.0	470.0
	D	470.0	475.0

Tolerance: ±1 nm

### Example

ASMT-MT00-00001

X<sub>1</sub> = 0 – Full Distribution

X<sub>2</sub> = 0 – Full Distribution

X<sub>3</sub> = 0 – Red (Full Distribution),  
Green (A, B, C and D),  
Blue (A, B, C and D)

X<sub>4</sub> = 1 – Tape and Reel Option

## CIE 1931 Chromaticity Diagram

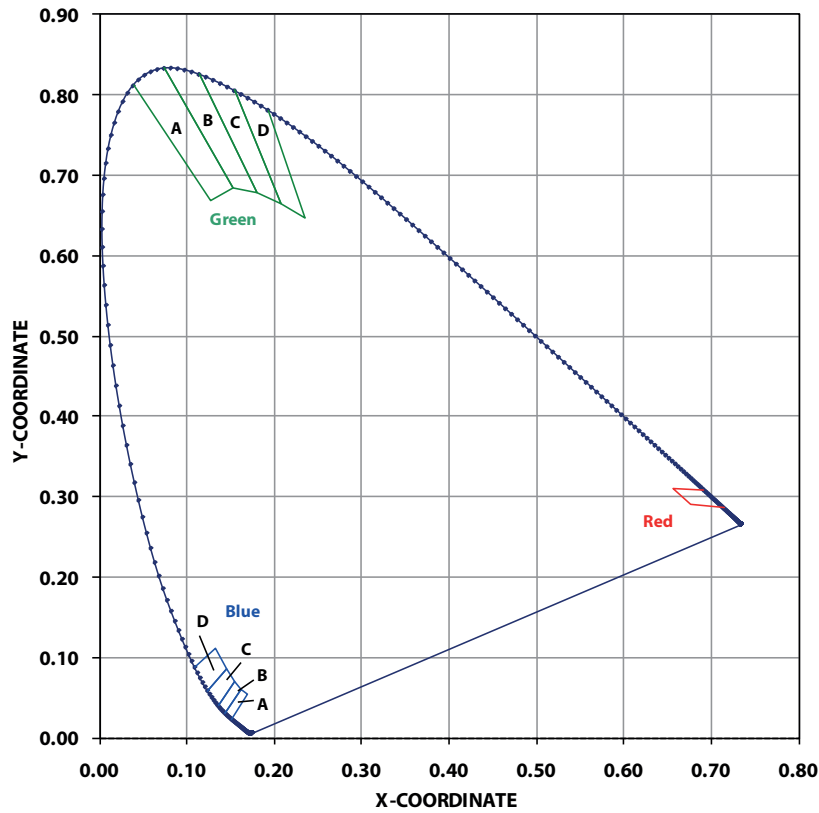
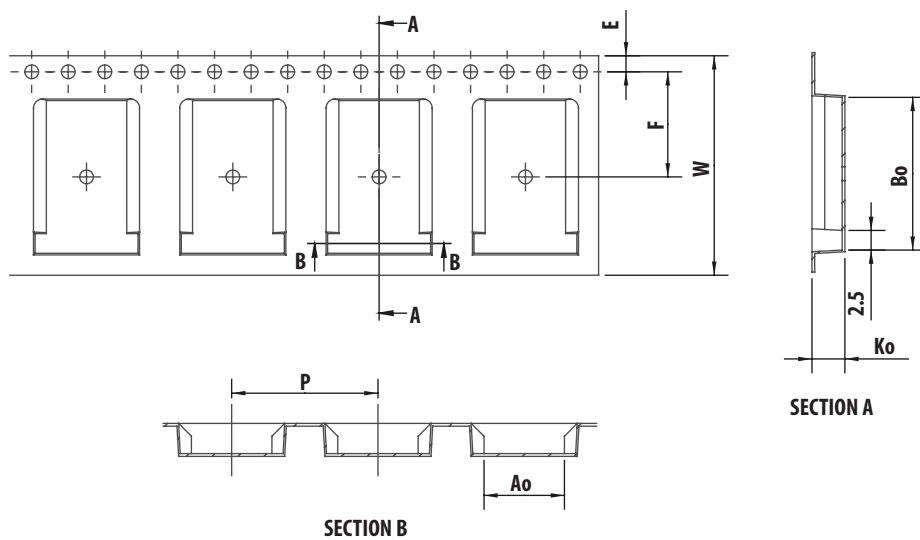

Figure 12. CIE 1931 Chromaticity Diagram.

## Tape and Reel – Option 1



Dim	Value
A <sub>0</sub>	8.80 ±0.10
B <sub>0</sub>	16.45 ±0.10
K <sub>0</sub>	3.60 ±0.1
E	1.75 ±0.10
F	11.50 ±0.10
W	24.0 ±0.10
P	16.0 ±0.10
Q'ty/Reel	250 units

All dimensions in mm.

Figure 13. Carrier tape dimensions.

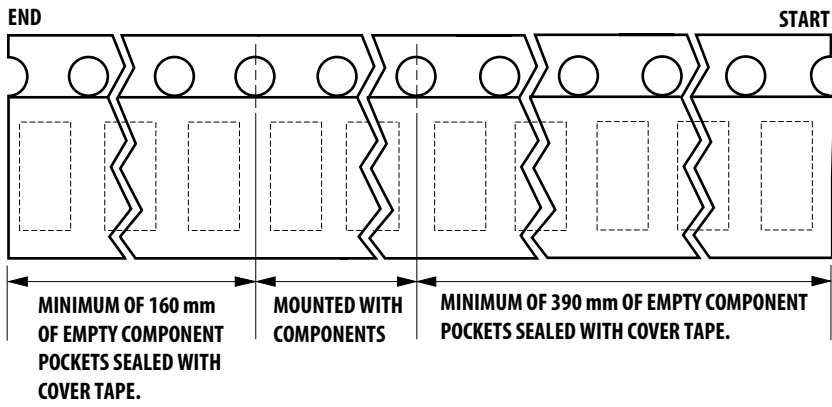

Figure 14. Carrier tape leader and trailer dimensions.

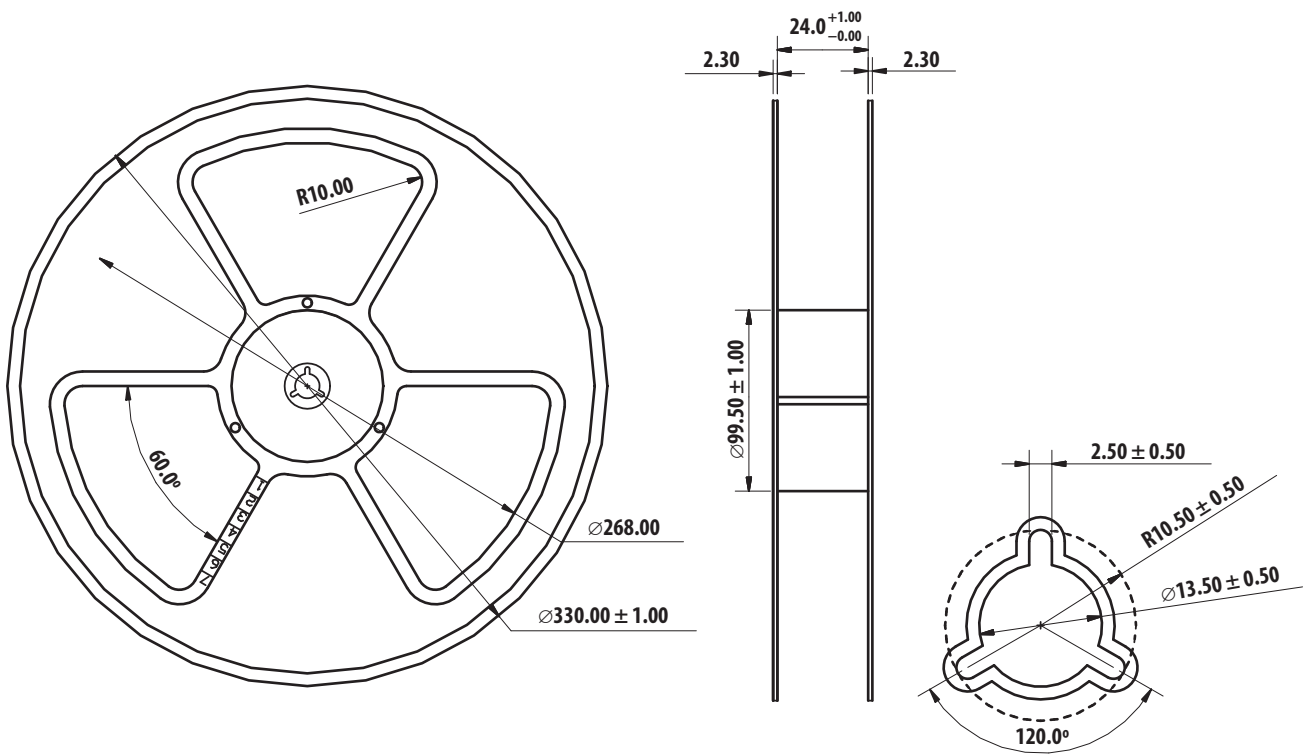

Figure 15. Reel dimensions.



## Handling Precaution

The encapsulation material of the product is made of silicone for better reliability of the product. As silicone is a soft material, please do not press on the silicone or poke a sharp object onto the silicone. These might damage the product and cause premature failure. During assembly or handling, the unit should be held on the body only. Please refer to Avago Application Note AN5288 for detail information.

## Moisture Sensitivity

This product is qualified as Moisture Sensitive Level 5a per Jedec J-STD-020. Precautions when handling this moisture sensitive product is important to ensure the reliability of the product. Do refer to Avago Application Note AN5305 Handling of Moisture Sensitive Surface Mount Devices for details.

### A. Storage before use

- Unopened moisture barrier bag (MBB) can be stored at <math>40^{\circ}\text{C}/90\%RH</math> for 12 months. If the actual shelf life has exceeded 12 months and the humidity indicator card (HIC) indicates that baking is not required, then it is safe to reflow the LEDs per the original MSL rating.
- It is not recommended to open the (MBB) prior to assembly (e.g. for IQC).

### B. Control after opening the MBB

- The humidity indicator card (HIC) shall be read immediately upon opening of MBB.
- The LEDs must be kept at <math>30^{\circ}\text{C}/60\%RH</math> at all time and all high temperature related process including soldering, curing or rework need to be completed within 24 hours.

### C. Control for unfinished reel

- For any unused LEDs, they need to be stored in sealed MBB with desiccant or desiccator at <math>5\%RH</math>.

### D. Control of assembled boards

- If the PCB soldered with the LEDs is to be subjected to other high temperature processes, the PCB need to be stored in sealed MBB with desiccant or desiccator at <math>5\%RH</math> to ensure no LEDs have exceeded their floor life of 24 hours.

### E. Baking is required if:

- HIC "10%" indicator is not blue and "5%" indicator is pink.
- The LEDs are exposed to condition of <math>30^{\circ}\text{C}/60\%RH</math> at any time.
- The LEDs floor life exceeded 24 hours.

Recommended baking condition:  $60\pm 5^{\circ}\text{C}$  for 20hrs.

**DISCLAIMER:** Avago's products and software are not specifically designed, manufactured or authorized for sale as parts, components or assemblies for the planning, construction, maintenance or direct operation of a nuclear facility or for use in medical devices or applications. Customer is solely responsible, and waives all rights to make claims against avago or its suppliers, for all loss, damage, expense or liability in connection with such use.

For product information and a complete list of distributors, please go to our web site: [www.avagotech.com](http://www.avagotech.com)

Avago, Avago Technologies, and the A logo are trademarks of Avago Technologies in the United States and other countries. Data subject to change. Copyright © 2005-2014 Avago Technologies. All rights reserved. AV02-1693EN - February 6, 2014

**AVAGO**  
TECHNOLOGIES