

### DomiLED<sup>TM</sup>

Synonymous with function and performance, the DomiLED<sup>TM</sup> series is perfectly suited for a variety of cross-industrial applications due to its small package outline, durability and superior brightness.

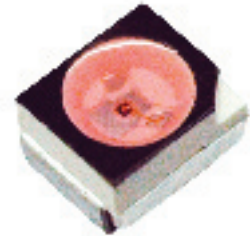

### Features:

- > High brightness surface mount LED using thin film technology.
- > 120° viewing angle.
- > Small package outline (LxWxH) of 3.2 x 2.8 x 1.8mm.
- > Qualified according to JEDEC moisture sensitivity Level 2.
- > Compatible to IR reflow soldering.
- > Environmental friendly; RoHS compliance.

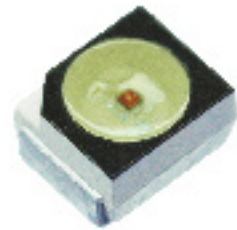

### Applications:

- > Automotive: interior applications, eg: switches, telematics, climate control system, dashboard, etc.
- > Consumer appliances: LCD illumination as in PDAs, LCD TV.
- > Communication: indicator and backlight in mobilephone.
- > Display: full color display video notice board.
- > Industrial: white goods (eg: Oven, microwave, etc.).



### Optical Characteristics at Tj=25°C

Part Ordering Number	Color	Viewing Angle°	Luminous Intensity @ 20mA IV (mcd)		
			Min.	Typ.	Max.
DRR-RJE-UV2-1	Red, 625nm	120	450.0	715.0	1125.0
● DRR-RJE-TU2-1	Red, 625nm	120	285.0	450.0	715.0
DRY-RJE-UV2-1	Yellow, 587nm	120	450.0	715.0	1125.0
DRY-RJE-VW1-1	Yellow, 587nm	120	715.0	1000.0	1400.0

● Not for new design

**NOTE**

1. All part number above comes in a quantity of 2000 units per reel.
2. Luminous intensity is measured with an accuracy of ± 11%.
3. Wavelength binning is carried for all units as per the wavelength-binning table. Only one wavelength group is allowed for each reel.

### Electrical Characteristics at Tj=25°C

Part Number	Vf @ If = 20mA			Vr @ Ir = 10uA
	Min. (V)	Typ. (V)	Max. (V)	Min. (V)
DRx-RJE	1.8	2.2	2.6	12

Forward voltage, Vf is measured with an accuracy of ± 0.1 V.

### Absolute Maximum Ratings

	Maximum Value	Unit
DC forward current	30	mA
Peak pulse current; (tp ≤ 10µs, Duty cycle = 0.005)	1000	mA
Reverse voltage	12	V
ESD threshold (HBM)	2000	V
LED junction temperature	120	°C
Operating temperature	-40 ... +100	°C
Storage temperature	-40 ... +100	°C
Power dissipation (at room temperature)	78	mW

**Wavelength Grouping at Tj= 25°C**

Color	Group	Wavelength distribution (nm)
DRR; Red	Full	620 - 630
DRY; Yellow	Full	582 - 594
	W	582 - 585
	X	585 - 588
	Y	588 - 591
	Z	591 - 594

Dominant wavelength is measured with an accuracy of  $\pm 1$  nm.

**Luminous Intensity Group at Tj=25°C**

Brightness Group	Luminous Intensity IV (mcd)
T1	285.00...355.00
T2	355.00...450.00
U1	450.00...560.00
U2	560.00...715.00
V1	715.00...900.00
V2	900.00...1125.00
W1	1125.00 ... 1400.00

Luminous intensity is measured with an accuracy of  $\pm 11\%$ .

**Relative Luminous Intensity Vs Forward Current**

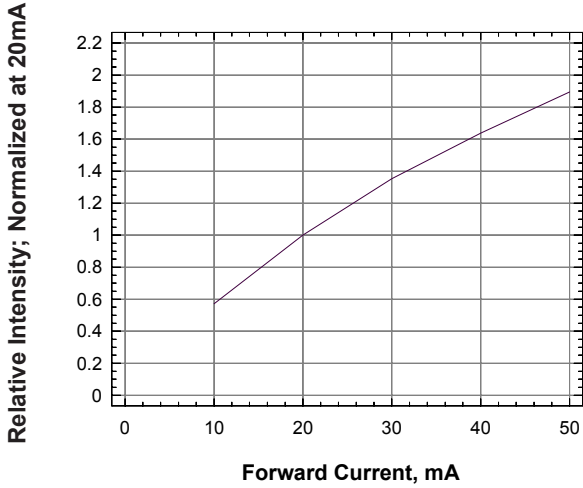

**Forward Current Vs Forward Voltage**

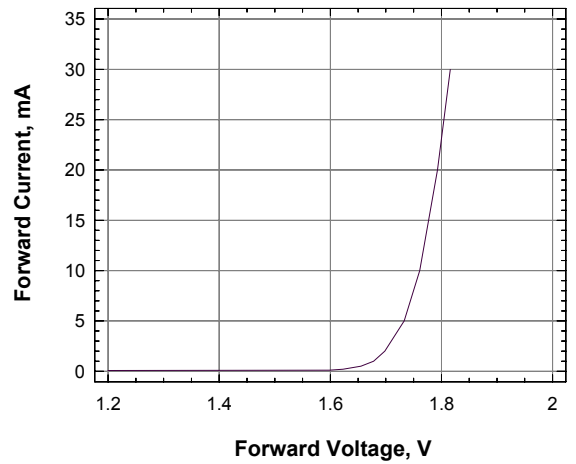

**Maximum Current Vs Temperature**

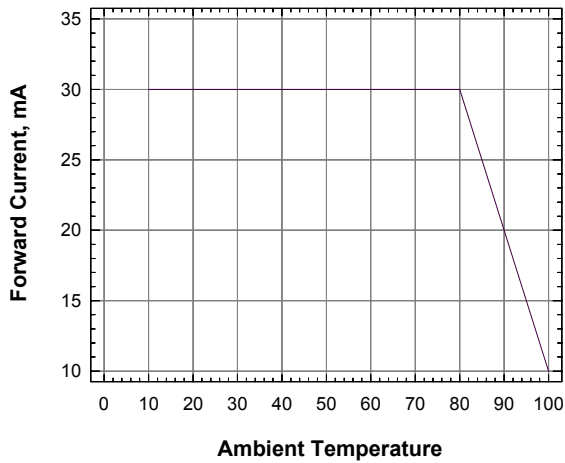

**Relative Intensity vs Wavelength**

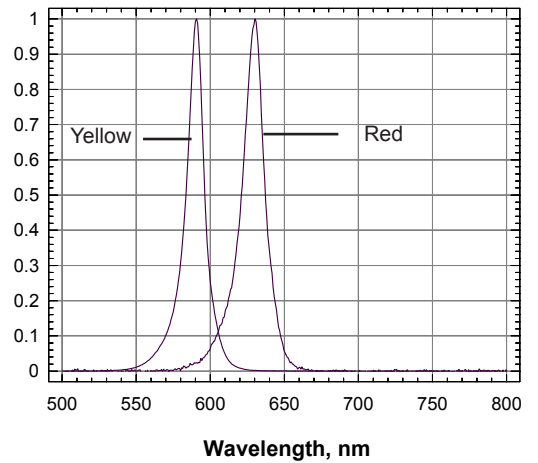

**Radiation Pattern**

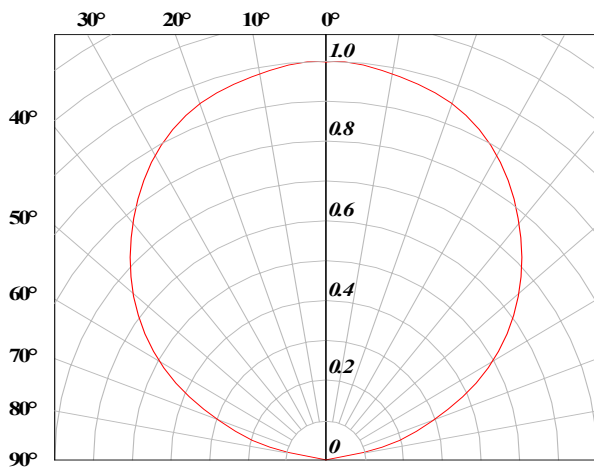

**DomiLED™ • Colored Resin : DRx-RJE Package Outlines**

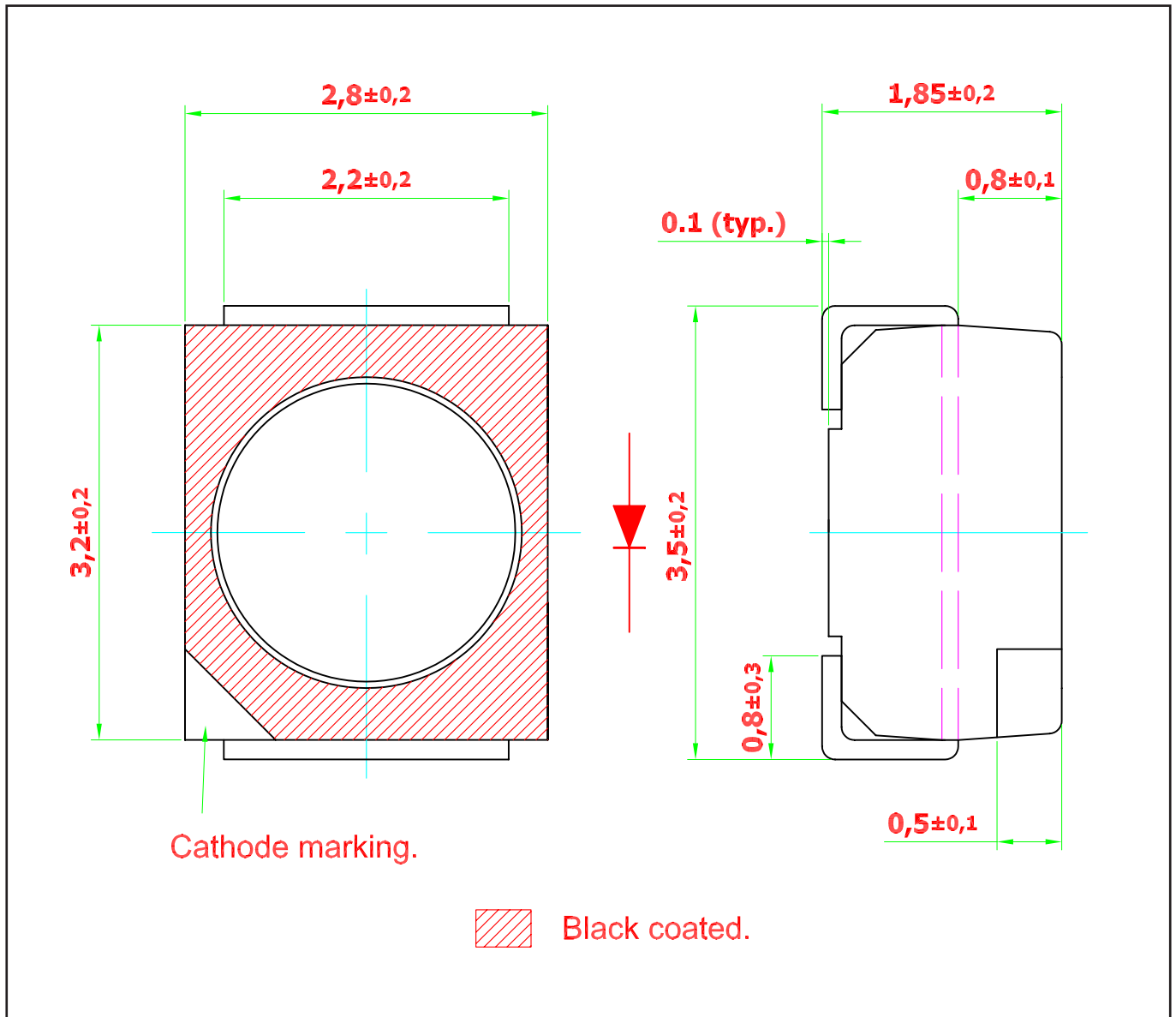

**Material**

Material	
Lead-frame	Cu Alloy With Ag Plating
Package	High Temperature Resistant Plastic, PPA
Encapsulant	Epoxy
Soldering Leads	Sn-Sn Plating

**Recommended Solder Pad**

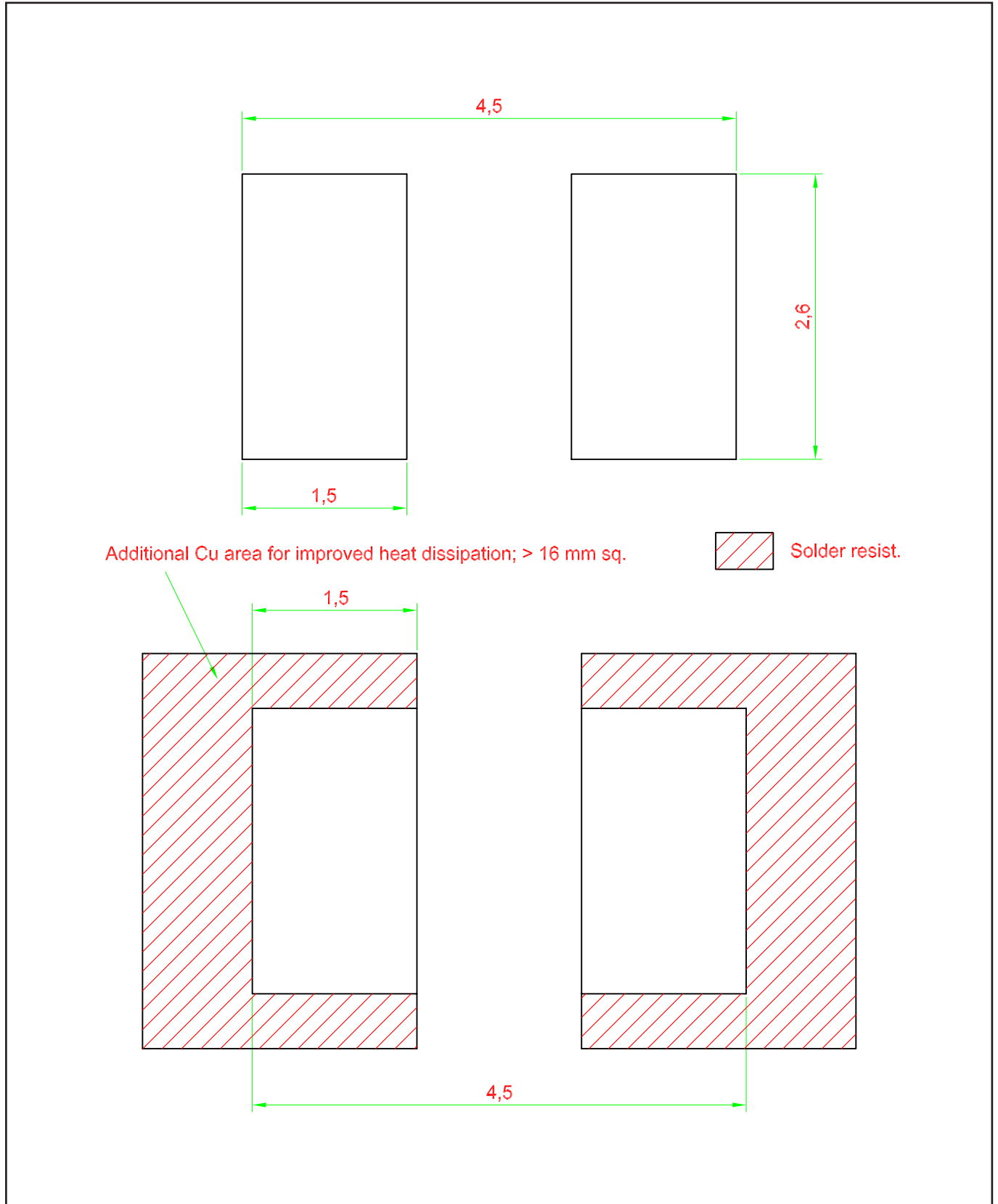

### Taping and orientation

- Reels come in quantity of 2000 units.
- Reel diameter is 180 mm.

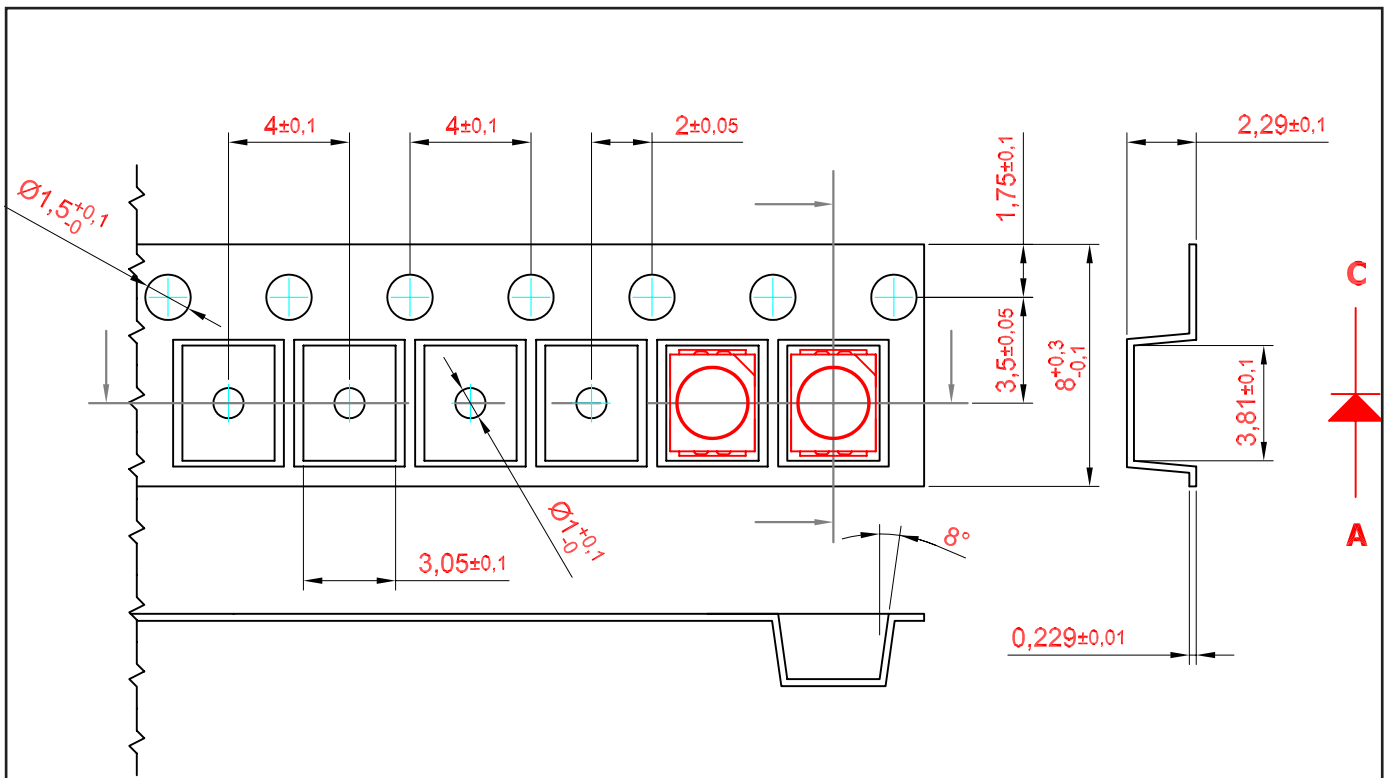

200 mm min. for  $\varnothing 180$  reel.

480 mm min. for  $\varnothing 180$  reel.

200 mm min. for  $\varnothing 330$  reel.

960 mm min. for  $\varnothing 330$  reel.

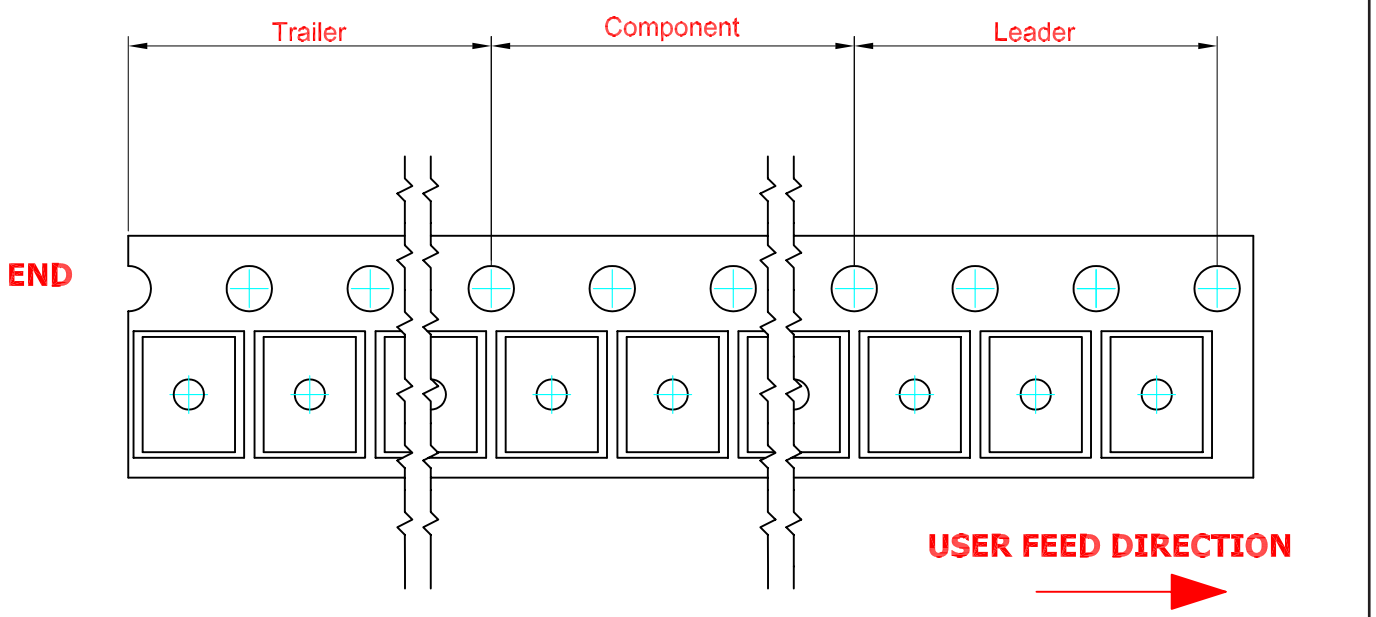

**Packaging Specification**

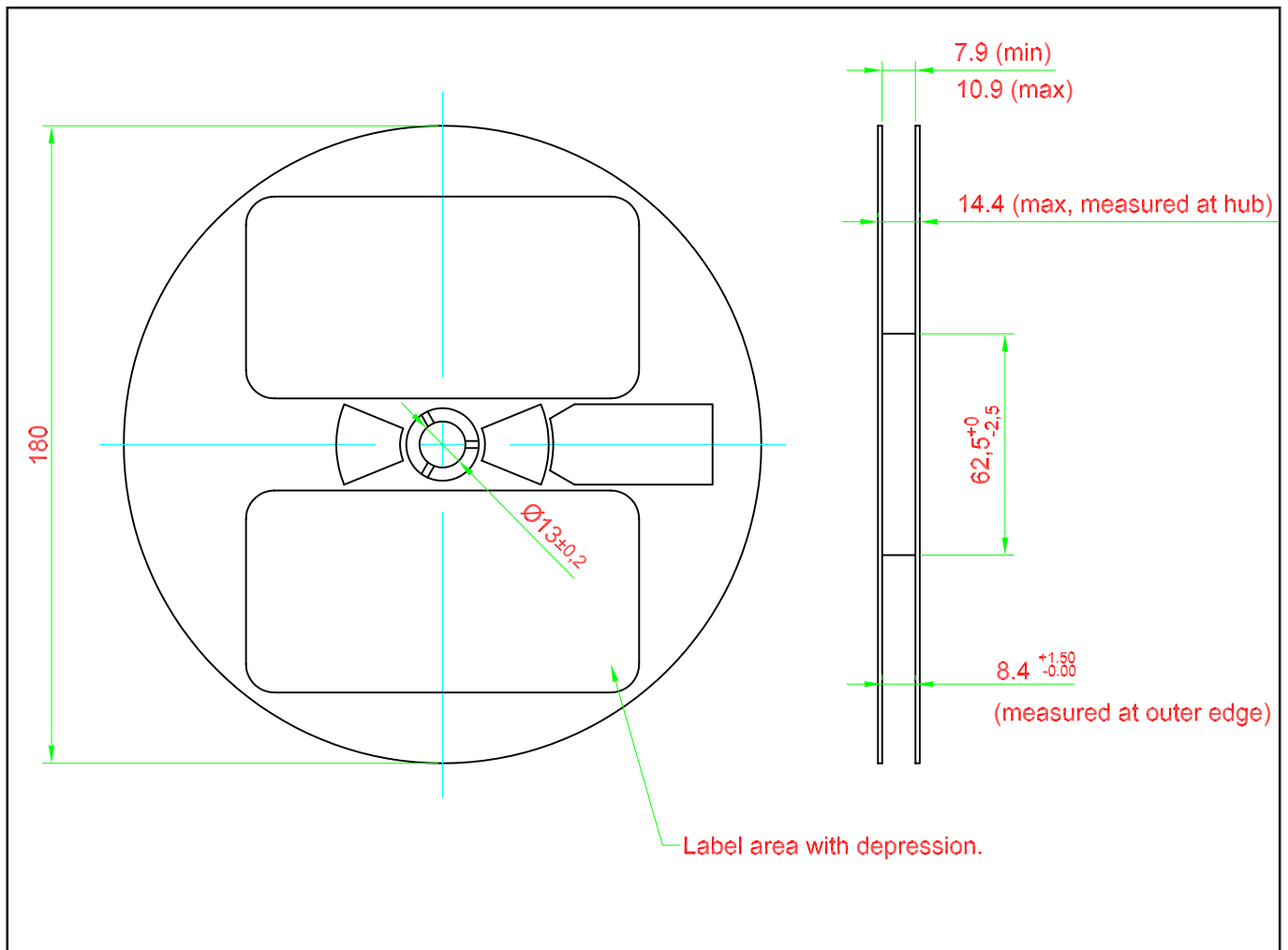



**Packaging Specification**

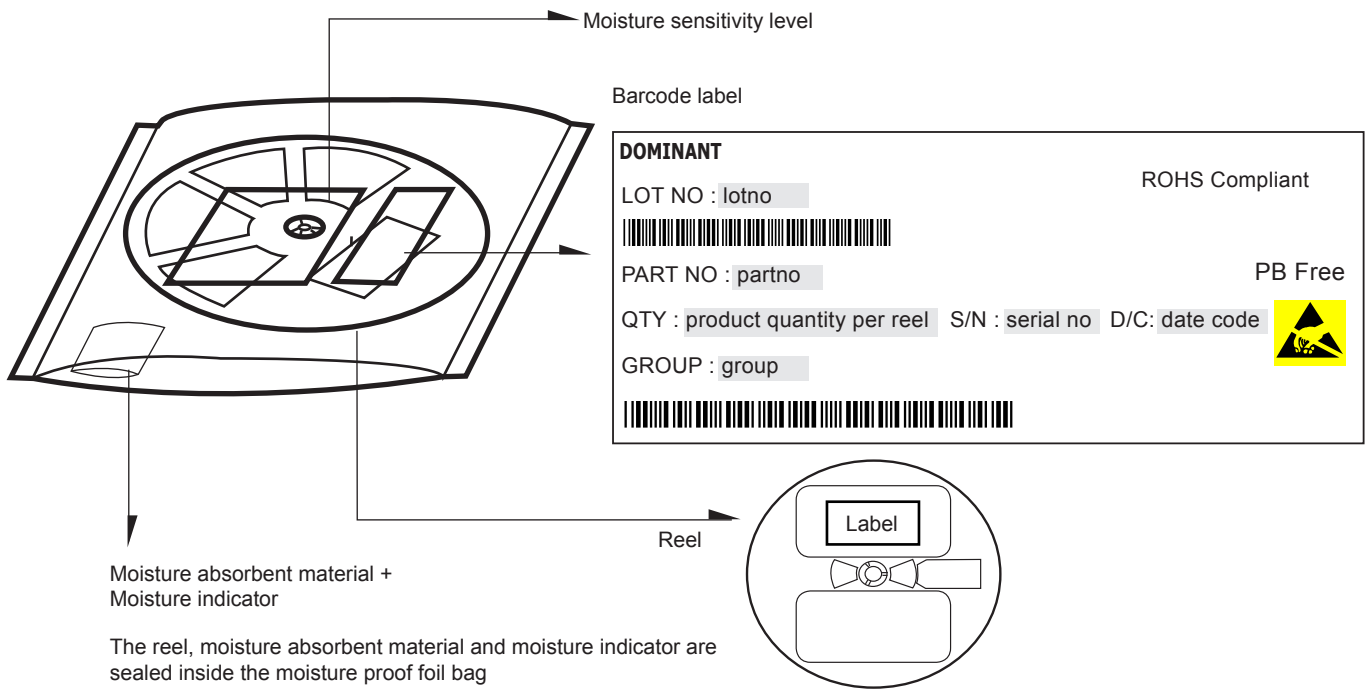

	Average 1pc DomiLED/Multi DomiLED	1 completed bag (2000pcs)
Weight (gram)	0.034	190 ± 10

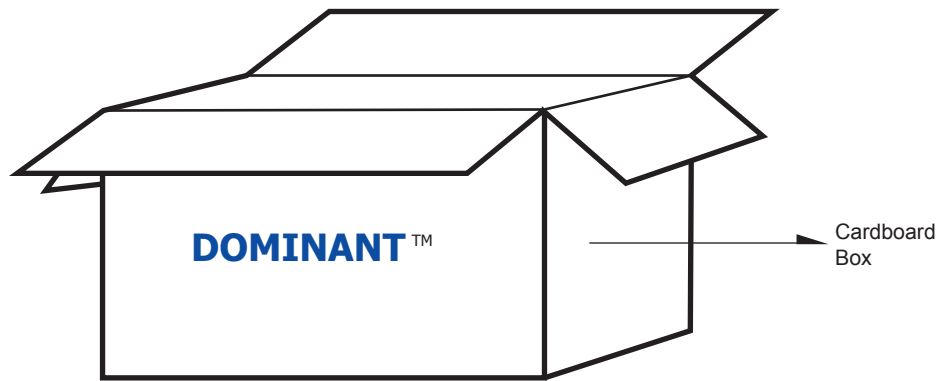

**For DomiLED™**

Cardboard Box Size	Dimensions (mm)	Empty Box Weight (kg)	Reel / Box	Quantity / Box (pcs)
Small	300 x 250 x 250	0.58	15 reels MAX	30,000 MAX
Large	416 x 516 x 476	1.74	96 reels MAX	192,000 MAX

**Recommended Sn-Pb IR-Reflow Soldering Profile**

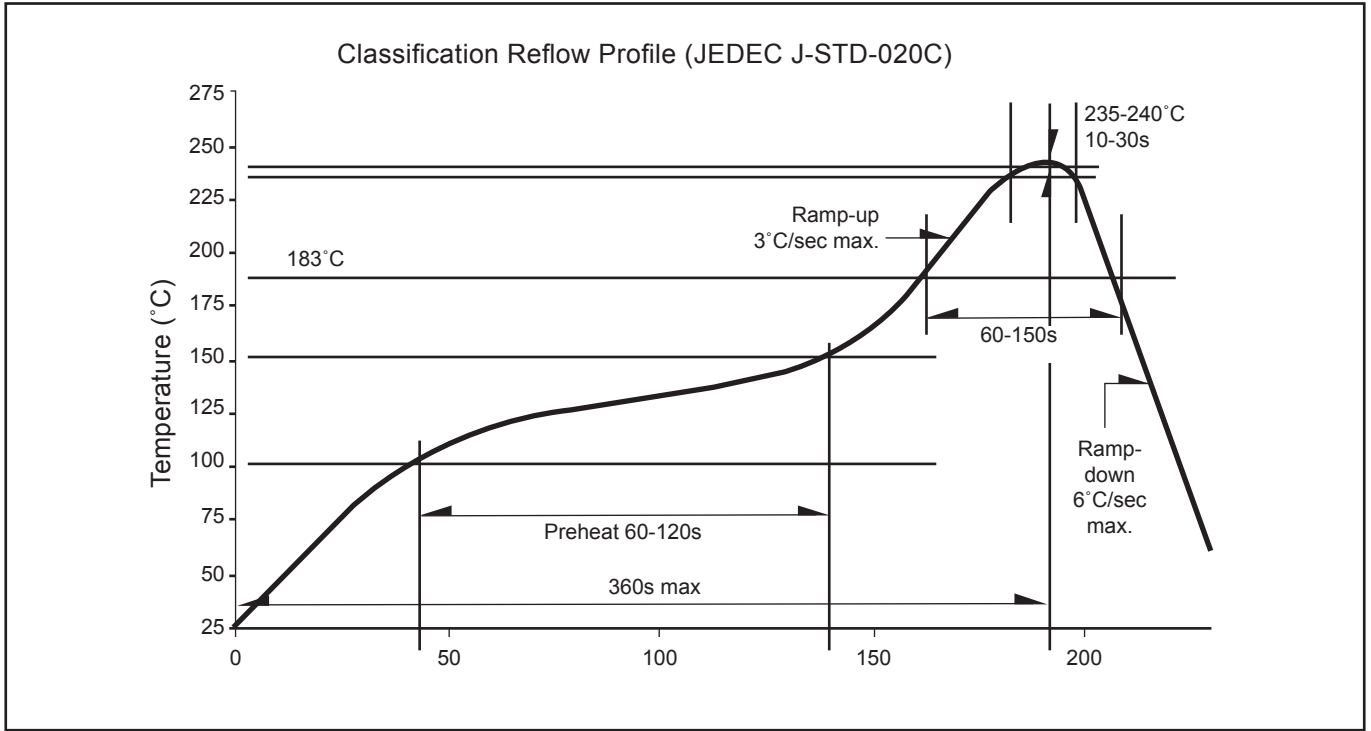

**Recommended Pb-free Soldering Profile**

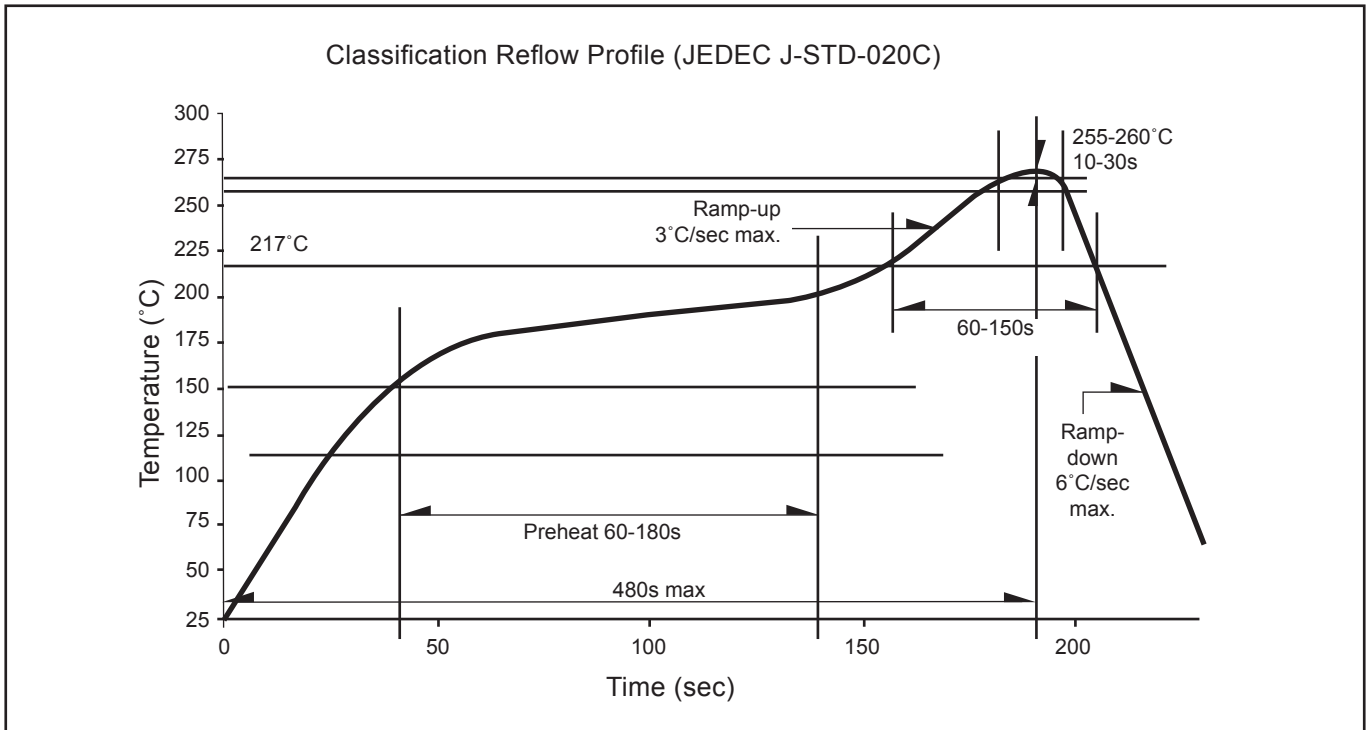

**Revision History**

Page	Subjects	Date of Modification
-	Initial Release	18 Feb 2008
2	Add new partno: DRR-RJE-TU2-1	17 Jun 2008
2	Not for new design: DRR-RJE-TU2-1	20 May 2009
-	Update company name	31 May 2010
2	Add new partno: DRY-RJE-VW1-1	29 Jun 2011

**NOTE**

All the information contained in this document is considered to be reliable at the time of publishing. However, DOMINANT Opto Technologies does not assume any liability arising out of the application or use of any product described herein.

DOMINANT Opto Technologies reserves the right to make changes at any time without prior notice to any products in order to improve reliability, function or design.

DOMINANT Opto Technologies products are not authorized for use as critical components in life support devices or systems without the express written approval from the Managing Director of DOMINANT Opto Technologies.

## About Us

DOMINANT Opto Technologies is a dynamic Malaysian Corporation that is among the world's leading SMT LED Manufacturers. An excellence – driven organization, it offers a comprehensive product range for diverse industries and applications. Featuring an internationally certified quality assurance acclaim, DOMINANT's extra bright LEDs are perfectly suited for various lighting applications in the automotive, consumer and communications as well as industrial sectors. With extensive industry experience and relentless pursuit of innovation, DOMINANT's state-of-art manufacturing, research and testing capabilities have become a trusted and reliable brand across the globe. More information about DOMINANT Opto Technologies can be found on the Internet at <http://www.dominant-semi.com>.

### **Please contact us for more information:**

#### Head Quarter

DOMINANT Opto Technologies Sdn. Bhd.  
Lot 6, Batu Berendam, FTZ Phase III, 75350 Melaka, Malaysia  
Tel: (606) 283 3566 Fax: (606) 283 0566  
E-mail: [sales@dominant-semi.com](mailto:sales@dominant-semi.com)

#### DOMINANT Semiconductors Malaysia Sdn. Bhd. Shanghai Representative Office

DOMINANT Semiconductors (Shenzhen) Co. Ltd.  
Rm 1007, DaZhong Building, No. 1515 Zhong Shan (W) Rd, Shanghai, China 200235  
Tel: +86 21 6428 6428 Fax: +86 21 6428 6880  
E-mail: [sales\\_china@dominant-semi.com](mailto:sales_china@dominant-semi.com)

#### DOMINANT Korea Sales Office

DOMINANT Semiconductors Korea Inc.  
RM 211 SUNTEAK CITY APT. 513-15 Sangdaewon-dong, Jungwon-gu, Seongnam-si, Gyeonggi-do, 462-725, Korea  
Tel: +82-31-701-5203 Fax: +82-31-701-5204  
E-mail: [sales\\_korea@dominant-semi.com](mailto:sales_korea@dominant-semi.com)

#### DOMINANT U.S.A Sales Office

25 Rockaway Road, 08833 Lebanon, New Jersey, USA  
Tel: (908) 439-9930 Cell: (908) 343-5810 Fax: (908) 439-9929  
E-mail: [don.wendel@dominant-semi.com](mailto:don.wendel@dominant-semi.com)

#### DOMINANT Europe Sales Office

DOMINANT Semiconductors Europe GmbH  
Raiffeisenstr. 38, 74906 Bad Rappenau Germany  
Tel: +49 (0) 7264-89010-10 / +49 (0) 7264-89010-11 Cell: +49 173-6907370 / +49 173-6907751  
Fax: +49 (0) 7264-89010-29  
E-mail: [gerd.wachno@dominant-semi.eu](mailto:gerd.wachno@dominant-semi.eu); [hartmut.wettengl@dominant-semi.eu](mailto:hartmut.wettengl@dominant-semi.eu)

#### DOMINANT India Sales Office

C-11,Vasanth Business Centre #86, TTK Road, Alwarpet Chennai - 600 018, INDIA  
Tel: 91-44-42030616 / 516 Cell: 91-9444920537 Fax: 91-9444920616  
E-mail: [pravat.behera@dominant-semi.com](mailto:pravat.behera@dominant-semi.com)

