

Features

- RoHS lead-free-solder and lead-solder-exempted products are available.
- Wide input voltage ranges up to 150 VDC
- 1 or 2 isolated outputs up to 48 V
- 1500 to 3000 VAC I/O voltage withstand test
- Emissions EN 55022 level A
- Immunity to IEC/EN 61000-4-2,-3,-4,-5, and -6
- Fire&smoke as per EN 45545
- High efficiency (typ. 86%)
- Input undervoltage lockout
- Shutdown input, adjustable output voltages
- Flex power: Flexible load distribution on outputs
- Outputs no-load, overload, and short-circuit proof
- Operating ambient temperature -40 to 85 °C
- Thermal protection
- 2" x 1.6" case with 10.5 mm profile
- Supplementary insulation: 20/40IMX15 models, double or reinforced insulation: 110IMY15 models
- Safety-approved to IEC 60950-1 and UL/CSA 60950-1 2nd Edition

Description

The IMX15, IMS15, and IMY15 Series of board mountable 15 Watt DC-DC converters have been designed according to the latest industry requirements and standards. The converters are particularly suitable for use in mobile or stationary applications in transport, railways, industry, or telecommunication, where variable input voltages or high transient voltages are prevalent.

Covering a total input voltage range from 8.4 up to 150 V with different models, the converters are available with single and electrically-isolated double outputs from 3.3 up to 48 V, externally adjustable, with flexible load distribution on double-output models. A shutdown input allows for remote on/off.

Features include efficient input and output filtering and consistently high efficiency over the entire input voltage range, high reliability, and excellent dynamic response to load and line changes.

The converters have been approved by CSA. 20IMS/20IMX15 and 40IMS/40IMX15 models provide supplementary insulation. Connected to a secondary circuit, these models provide SELV



outputs, even if the bus voltage at the converter input exceeds the SELV-limit of 60 VDC. The 110IMY15 models provide double insulation and are CE marked. They may be connected to a rectified 110 VAC source without any further isolation barrier.

The circuitry is comprised of integrated planar magnetics. All components are automatically assembled and solidly soldered onto a single PCB without any wire connection. Magnetic feedback ensures maximum reliability and repeatability in the control loop over all operating conditions. Careful consideration of possible thermal stress ensures the absence of hot spots providing long life in environments, where temperature cycles are frequent. The thermal design allows operation at full load up to an ambient temperature of 71 °C in free air without using any potting material. For extremely high vibration environments the case has holes for screw mounting.

Table of Contents

	Page		Page
Description	1	Electromagnetic Compatibility (EMC)	14
Model Selection	2	Immunity to Environmental Conditions	16
Functional Description	4	Mechanical Data	17
Electrical Input Data	5	Safety and Installation Instructions	18
Electrical Output Data	8	Description of Options	19
Auxiliary Functions	13	Accessories	19

Copyright © 2017, Bel Power Solutions Inc. All rights reserved.



Model Selection

Table 1: Model Selection

Output 1		Output 2		Output power $P_{o\ nom}$ [W]	Input voltage $V_{i\ min}$ to $V_{i\ max}$ [VDC]	Efficiency		Model	Options ²
$V_{o\ nom}$ [VDC]	$I_{o\ nom}$ ¹ [A]	$V_{o\ nom}$ [VDC]	$I_{o\ nom}$ ¹ [A]			η_{min} ⁶ [%]	η_{typ} ⁶ [%]		
3.3	4.5	-	-	14.9	8.4 to 36 ⁵	80	82	20IMX15-03-8RG-G ^{SR}	i, Z, non-G
3.3	4.0	-	-	13.2	16.8 to 75 ³	78	80	40IMX15-03-8RG	non-G
3.3	4.5	-	-	14.9	16.8 to 75 ³	81	83	40IMX15-03-8RG-G ^{SR}	i, Z, non-G
3.3	4.5	-	-	14.9	50 to 150 ⁴	77	79	110IMY15-03-8RG-G ^{SR}	i, Z, non-G
5.1	3.5	-	-	17.5	8.4 to 36 ⁵	83	86	20IMX15-05-8RG-G ^{SR}	i, Z, non-G
5.1	3.5	-	-	17.5	16.8 to 75 ³	85	87	40IMX15-05-8RG-G ^{SR}	i, Z, non-G
5.1	3.5	-	-	17.5	50 to 150 ⁴	79.5	82	110IMY15-05-8RG-G ^{SR}	i, Z, non-G
5.1	2.3	-	-	11.7	8.4 to 36 ⁵	82	84	20IMX15-05-8RG	Z, non-G
5.1	2.7	-	-	13.8	14 to 36	81.5	84	24IMS15-05-9R	--
5.1	2.5	-	-	12.8	16.8 to 75 ³	81.5	83	40IMX15-05-8RG	--
5.1	2.5	-	-	12.8	50 to 150 ⁴	78	81	110IMY15-05-8RG	Z, non-G
5.1	1.35	3.3	1.35	11.3	8.4 to 36 ⁵	82	84	20IMX15-0503-8RG	i, Z, non-G
5.1	1.6	3.3	1.6	13.5	14 to 36	81	83	24IMS15-0503-9R	--
5.1	1.5	3.3	1.5	12.6	16.8 to 75 ³	82	84	40IMX15-0503-8RG	i, Z, non-G
5.1	1.6	3.3	1.6	13.5	36 to 75	79	82	48IMS15-0503-9R	--
5.1	1.5	3.3	1.5	12.6	50 to 150 ⁴	79	82	110IMY15-0503-8RG	i, Z, non-G
5	1.3	5	1.3	13.0	8.4 to 36 ⁵	82	85	20IMX15-05-05-8G	i, Z, non-G
5	1.4	5	1.4	14.0	14 to 36	81	84	24IMS15-05-05-9	--
5	1.4	5	1.4	14.0	16.8 to 75 ³	81	84	40IMX15-05-05-8G	i, Z, non-G
5	1.4	5	1.4	14.0	50 to 150 ⁴	80	82	110IMY15-05-05-8G	i, Z, non-G
12	0.65	12	0.65	15.6	8.4 to 36 ⁵	83	86	20IMX15-12-12-8G	i, Z, non-G
12	0.7	12	0.7	16.8	14 to 36	83	86	24IMS15-12-12-9	--
12	0.7	12	0.7	16.8	16.8 to 75 ³	84	87	40IMX15-12-12-8G	i, Z, non-G
12	0.7	12	0.7	16.8	50 to 150 ⁴	82	85	110IMY15-12-12-8G	i, Z, non-G
15	0.5	15	0.5	15.0	8.4 to 36 ⁵	85	88	20IMX15-15-15-8G	i, Z, non-G
15	0.56	15	0.56	16.8	14 to 36	83	86	24IMS15-15-15-9	--
15	0.56	15	0.56	16.8	16.8 to 75 ³	83	86	40IMX15-15-15-8G	i, Z, non-G
15	0.56	15	0.56	16.8	50 to 150 ⁴	82	85	110IMY15-15-15-8G	i, Z, non-G
24	0.32	24	0.32	15.4	8.4 to 36 ⁵	83	86	20IMX15-24-24-8G	i, Z, non-G
24	0.35	24	0.35	16.8	14 to 36	84	87	24IMS15-24-24-9G	non-G
24	0.35	24	0.35	16.8	16.8 to 75 ³	84	86	40IMX15-24-24-8G	i, Z, non-G
24	0.35	24	0.35	16.8	50 to 150 ⁴	82	85	110IMY15-24-24-8G	i, Z, non-G

¹ Flexible load distribution on dual and double outputs possible; up to 75% of the total output power $P_{o\ nom}$ on one of the 2 outputs. IMX/IMY15-0503 models have reduced load distribution flexibility; 1.8 A max. on one of the 2 outputs. The total output power should not exceed $P_{o\ nom}$.

² See Description of Options.

³ Short-time operation down to $V_i = 14.4$ V possible (P_o reduced to approx. 85% of $P_{o\ nom}$)

⁴ Short-time operation down to $V_i = 43.2$ V possible (P_o reduced to approx. 85% of $P_{o\ nom}$) and up to 154 V

⁵ Initial start-up at 9 V, main output voltage regulation down to 8.4 V

⁶ Efficiency at $T_A = 25$ °C, $V_{i\ nom}$, $I_{o\ nom}$.

^{SR} Models with synchronos rectifier. For the RoHS version of such models, add -G !

Preferred for new designs.

NFND Not for new designs. Replace 24IMS15 models by 20IMX15 and 48IMS15 by 40IMX15;
 Replace 20IMX15-05, 40IMX15-05, 110IMY15-05 by models with synchronos rectifier^{SR};
 for new designs, chose always the RoHS version !

RoHS-Compliant Models

The type designation of RoHS-compliant models (compliant for the restriction of all six substances) for the IMX/IMY15 Series ends with "G".

However, in **single-output models** with 3.3 V or 5.1 V output an extra hyphen (-) is added after the existing "G", which already signifies a synchronous rectifier^{SR}. This is an exception to our normal nomenclature to identify this type of product, since G is already used to designate products for higher output current fitted with a synchronous rectifier. Some examples

- 20IMX15-05-8R-G designates a standard version with RoHS compliance for all six substances.
- 20IMX15-05-8RG designates a synchronous rectifier^{SR} version which is not RoHS-compliant.
- 20IMX15-05-8RG-G designates a synchronous rectifier^{SR} version and RoHS compliant for all six substances.
- 20IMX15-05-05-8G designates a double-output model with RoHS compliance for all six substances
- 110IMY15-24-24-8RG designates a double-output model with RoHS compliance for all six substances.

Part Number Description

		40 IMX15 -05 -8 R G Z -G
Input voltage range V_i		
8.4 to 36 V	20	
14 to 36 V	24	
16.8 to 75 V	40	
36 to 75 V	48	
50 to 150 V	110	
Series	IMX15, IMS15, IMY15	
Output voltage of output 1	03, 05, 12, 15, 24	
Hyphen designating double-output models with two electrically isolated outputs	- ¹	
Output voltage of output 2	03, 05, 12, 15, 24	
Operating ambient temperature range T_A		
-40 ⁶ to 85 °C	-8	6
-40 to 71 °C	-9	2
Options and features:		
R input and magnetic feedback	R	3
Synchronous rectification	G	
Inhibit	i	4
Open frame	Z	
RoHS-compliant for all 6 substances	G or -G	5

¹ Not applicable to -0503 models. They have a common ground.

² IMS15 models are not recommended for new designs.

³ Standard for single-output and -0503 models

⁴ Option i replaces the standard shutdown function; see *Description of Options*.

⁵ RoHS models with synchronous rectifier end as an exception with -G.

⁶ Only -25 °C for older -8RG^{SR} models (Rev. < BA); see table 7a.

Note: The sequence of options must follow the order above !

Examples: 20IMX15-05-05-8G: DC-DC converter, input 9 to 36 V, 2 galvanically isolated outputs each providing 5 V, 1.3 A, RoHS-compliant

110IMY15-0503-8RG: DC-DC converter, input 50 to 150 V, 2 outputs with common return providing +5.1 V, 1.5 A and +3.3 V, 1.5 A, RoHS-compliant. Converter fitted with magnetic feedback for tight output voltage regulation.

Product Marking

The converters without option Z are marked with basic type designation, input and output voltages and currents, applicable safety approval and recognition marks, patent nos., company logo, date code, and serial number.

Functional Description

The IMX15/IMS15/IMY15 Series of DC-DC converters are magnetic feedback-controlled flyback converters using current mode PWM (Pulse Width Modulation). The -05- and -0503-output voltage models exhibit an active magnetic feedback loop via a pulse transformer, resulting in very tight regulation of the output voltage (see the block diagrams). The output voltages of these models can be adjusted via the R-input. The R-input is referenced to the secondary side and allows for programming the output voltages in the range of approximately 80 to 105% of $V_{o\ nom}$, using either an external resistor or an external voltage source.

Several single-output models with 3.3 or 5.1 V output exhibit a synchronous rectifier to improve the efficiency.

The voltage regulation on the double-output models is achieved with an auxiliary winding of the main transformer. The output voltages can be adjusted via the Trim input, which is referenced to the primary side and allows for programming the output voltage in the range of 100 to 105% of $V_{o\ nom}$ via an external resistor, or within 75 to 105% if using an external voltage source. The load regulation output characteristic allows for paralleling of one or more double-output models with equal output voltage.

Current limitation is provided by the primary circuit, thus limiting the total output power of double-output models. The shutdown input allows remote converter on/off.

Overtemperature protection will disable the converter under excessive overload conditions with automatic restart.

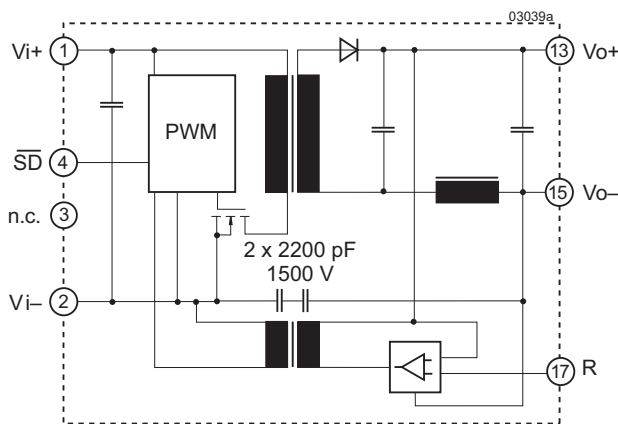

Fig. 1
Block diagram of single-output models

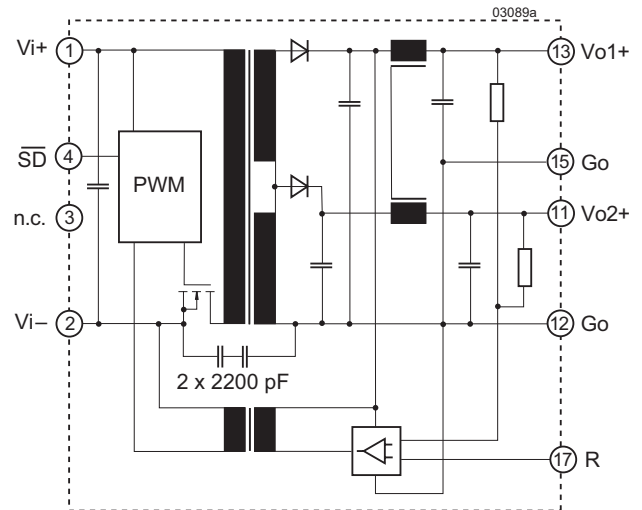

Fig. 2
Block diagram of -0503-models

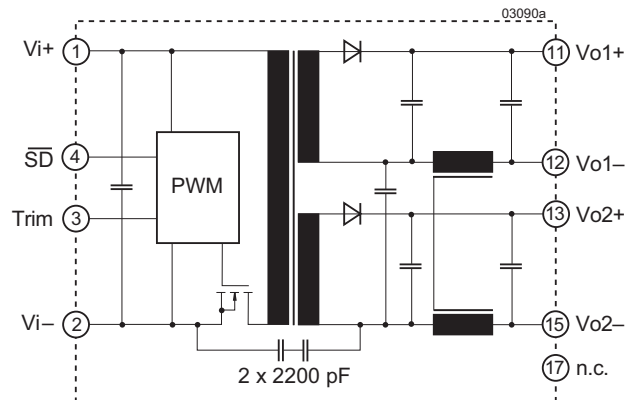

Fig. 3
Block diagram of double-output models

Electrical Input Data

General conditions:

- $T_A = 25\text{ °C}$, unless T_C is specified.
- Shut-down pin left open-circuit.
- Trim or R input left open-circuit.

Table 2a: Input data of IMX15 and IMY15 models

Input			20IMX			40IMX			110IMY			Unit
Characteristics		Conditions	min	typ	max	min	typ	max	min	typ	max	
V_i	Input voltage range ¹	$T_{A\min} - T_{A\max}$	9 ^{5,7}		36	16.8 ^{5,6}		75	50 ⁵		150 ⁸	V
$V_{i\text{nom}}$	Nominal input voltage	$I_o = 0 - I_{o\text{nom}}$		20			40			110		
$V_{i\text{sur}}$	Repetitive surge voltage	Abs. max input (3 s)			40			100			168	
t_{startup}	Converter start-up time ²	Switch on		0.25	0.5		0.25	0.5		0.5	0.8	s
		$\overline{\text{SD}}$ high			0.1			0.1			0.1	
t_{rise}	Rise time ²	$V_{i\text{nom}}$, resistive load		5			5			5		ms
		$I_{o\text{nom}}$, capac. load		10	20		10	20		10	20	
I_{i0}	No-load input current	$I_o = 0, V_{i\min} - V_{i\max}$			65			45			15	mA
I_{irr}	Reflected ripple current	$I_o = 0 - I_{o\text{nom}}$			30			30			20	mA _{pp}
$I_{\text{inr.p}}$	Inrush peak current ³	$V_i = V_{i\text{nom}}$			8			9			10	A
C_i	Input capacitance	for surge calculation		1.5			0.75			0.35		μF
$V_{\overline{\text{SD}}}$	Shut-down voltage	Converter disabled		-10 to 0.7			-10 to 0.7			-10 to 0.7		V
		Converter operating		open or 2 – 20			open or 2 – 20			open or 2 – 20		
$R_{\overline{\text{SD}}}$	Shut-down input resistance			approx. 10			approx. 10			approx. 10		kΩ
$I_{\overline{\text{SD}}}$	Input current, when disabled	$V_{i\min} - V_{i\max}$ $\overline{\text{SD}}$ connected to Vi-			10			3			1	mA
f_s	Switching frequency	$V_{i\min} - V_{i\max}$, $I_o = 0 - I_{o\text{nom}}$		approx. 300			approx. 300			approx. 300		kHz
$V_{i\text{RFI}}$	Input RFI level conducted	EN 55032 ⁴		A			A			A		

¹ If V_o is set above $V_{o\text{nom}}$ by use of the R or Trim input, $V_{i\min}$ will be proportionately increased.

² Measured with resistive and max. admissible capacitive load. Valid for models with rev. A1 or greater.

³ Source impedance according to ETS 300132-2, version 4.3.

⁴ Measured with a ceramic capacitor C_i directly across input; output lead length 0.1 m, leads twisted. Double-output models with both outputs in parallel. C_i is specified in table 11.

⁵ Input undervoltage lockout at typ. 80% of $V_{i\min}$.

⁶ Short time operation down to $V_{i\min} > 14.4\text{ V}$ possible. P_o reduced to approx. 85% of $P_{o\text{nom}}$.

⁷ Initial start-up at $V_i = 9\text{ V}$, main output voltage regulation down to 8.4 V

⁸ Short time operation up to 154 V possible for 2 s.

Table 2b: Input Data of IMS15 models; general conditions as in table 2a

Input			24IMS			48IMS			Unit	
Characteristics		Conditions	min	typ	max	min	typ	max		
V_i	Input voltage range ¹		$T_{A \min} - T_{A \max}$		14	36		36	75	V
$V_{i \text{ nom}}$	Nominal input voltage		$I_o = 0 - I_{o \text{ nom}}$		24		48			
$V_{i \text{ sur}}$	Repetitive surge voltage		Abs. max input (3 s)		50		100			
t_{startup}	Converter start-up time ²	Switch on	Worst case condition at $V_{i \min}, I_o = I_{o \text{ nom}}$		0.25	0.5		0.25	0.5	s
		$\overline{\text{SD}}$ high			0.1		0.1			
t_{rise}	Rise time ²		$V_{i \text{ nom}}$, resistive load		5		5		ms	
			$I_{o \text{ nom}}$, capac. load		10	20	10	20		
$I_{i \text{ o}}$	No-load input current		$I_o = 0, V_{i \min} - V_{i \max}$		20	40		10	20	mA
$I_{i \text{ rrr}}$	Reflected ripple current		$I_o = 0 - I_{o \text{ nom}}$		30		30		mA_{pp}	
$I_{i \text{ nrp}}$	Inrush peak current ³		$V_i = V_{i \text{ nom}}$		5		4.5		A	
C_i	Input capacitance		for surge calculation		4		2		μF	
$\overline{V_{\text{SD}}}$	Shut-down voltage		Converter disabled		-10 to 0.7		-10 to 0.7		V	
			Converter operating		open or 2 - 20		open or 2 - 20			
$\overline{R_{\text{SD}}}$	Shut-down input resistance				approx. 10		approx. 10		k Ω	
$\overline{I_{\text{SD}}}$	Input current, when disabled		$V_{i \min} - V_{i \max}$ $\overline{\text{SD}}$ connected to Vi-		1.2	3		1.2	3	mA
f_s	Switching frequency		$V_{i \min} - V_{i \max},$ $I_o = 0 - I_{o \text{ nom}}$		approx. 300		approx. 300		kHz	
$V_{i \text{ RFI}}$	Input RFI level conducted		EN 55022 ⁴		A		A			

¹ If V_o is set above $V_{o \text{ nom}}$ by use of the R or Trim input, $V_{i \min}$ will be proportionately increased.

² Measured with resistive and max. admissible capacitive load.

³ Source impedance according to ETS 300132-2, version 4.3.

⁴ Measured with a ceramic capacitor C_i directly across input; output lead length 0.1 m, leads twisted. Double-output models with both outputs in parallel. C_i is specified in table 11.

⁵ Input undervoltage lockout at typ. 80% of $V_{i \min}$.

Inrush Current

The inrush current has been made as low as possible by choosing a very small input capacitance. A series resistor may be installed in the input line to further reduce this current.

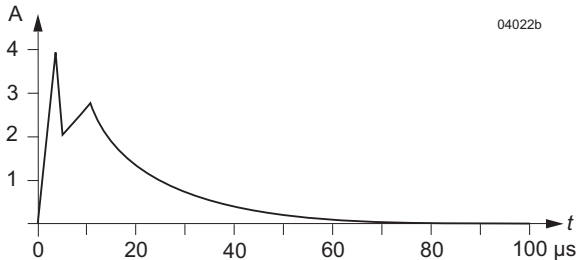

Fig. 4
 Typical inrush current at $V_{i\text{nom}}$, $P_{o\text{nom}}$ versus time (40IMX15). Source impedance according to ETS 300132-2 at $V_{i\text{nom}}$.

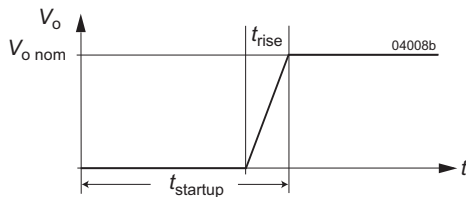

Fig. 5
 Converter start-up and rise time

Input Undervoltage Lockout

A special feature of these converters is the accurate undervoltage lockout protection, which protects against large currents caused by operation at low voltages. This ensures easier start-up in distributed power systems.

Tab. 3: Turn on and turn off voltage

Model	Turn on		Turn off		Unit
	min	max	min	max	
20IMX15	7.5	8	7	7.5	V
24IMS15	12.5	13.5	12	13	
40IMX15	12.5	13.5	12	13	
48IMS15	31.5	32.5	31	32	
110IMY15	40	42.5	38	40.5	

Fuse and Reverse Polarity Protection

The built-in suppressor diode also provides for reverse polarity protection at the input by conducting current in the reverse direction. An external fuse is required to limit this current.

Table 4: Recommended external fuses

Model	Fuse type
20IMX15	F 4.0 A
24IMS15	F 3.15 A
40IMX15, 48IMS15	F 2.0 A
110IMY15	F 1.0 A

Input Transient Voltage Protection

A built-in suppressor diode provides effective protection against input transients, which typically occur in many installations.

Table 5: Built-in transient voltage suppressor

Type	Breakdown voltage $V_{Br\text{nom}}$ [V]	Peak power at 1 ms P_p [W]	Peak pulse current I_{pp} [A]
20IMX15	40	1500	22
24IMS15	53	600	7.7
40IMX15	100	1500	9.7
48IMS15	100	600	4.1
110IMY15	168	600	0.5

For very high energy transients as for example to achieve compliance to IEC/EN 61000-4-5 (see table *Electromagnetic Immunity*), an external inductor and a capacitor are required, see Fig. 6. The components are specified in table 6.

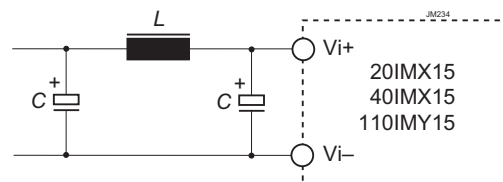

Fig. 6
 Example for external circuitry to achieve better transient immunity. Values of components in the table below.

Table 6:
 Components for external circuitry for IEC/EN 61000-4-5, level 3 compliance.

Model	Inductor (L)	Capacitor (C)
20IMX15	220 μ H, 2.7 A	2 x 330 μ F, 63 V
24IMS15	220 μ H, 1.3 A	2 x 330 μ F, 63 V
40IMX15	220 μ H, 1.3 A	2 x 330 μ F, 100 V
48IMS15	220 μ H, 1 A	2 x 330 μ F, 100 V
110IMY15	220 μ H, 0.4 A	2 x 330 μ F, 200 V

Electrical Output Data

We recommend connecting an external 1 μ F ceramic capacitor across the output pins.

General conditions:

- $T_A = 25\text{ }^\circ\text{C}$, unless T_C is specified
- Shutdown pin and Trim or R pin left open-circuit (not connected)

Table 7a: Output data for single-output models -03-8RG¹ and 05-8RG¹

Output		Conditions	3.3 V			5.1 V			Unit
Characteristics			min	typ	max	min	typ	max	
V_o	Output voltage	$V_{i\text{ nom}}$ $I_o = 0.5 I_{o\text{ nom}}$	3.25		3.35	5.05		5.15	V
$I_{o\text{ nom}}$	Output current	$V_{i\text{ min}}$ to $V_{i\text{ max}}$		4.5			3.5		A
	20IMX 40IMX/110IMY			4.5			3.5		
$I_{o\text{ L}}$	Current limit ²	$V_{i\text{ nom}}$, $T_C = 25\text{ }^\circ\text{C}$ $V_o \leq 93\% V_{o\text{ nom}}$		6.0			4.6		
ΔV_o	Line/load regulation	$V_{i\text{ min}}$ to $V_{i\text{ max}}$, (0.1 to 1) $I_{o\text{ nom}}$			± 0.5			± 0.5	%
V_o	Output voltage noise	$V_{i\text{ min}}$ to $V_{i\text{ max}}$ $I_o = I_{o\text{ nom}}$			100			100	mV _{pp}
					60			60	
$V_{o\text{ L}}$	Output overvoltage limit. ³		115		130	115		130	%
$C_{o\text{ ext}}$	Admissible capacitive load		0		4000 ⁶	0		4000 ⁶	μ F
$V_{o\text{ d}}$	Dynamic load regulation	Voltage deviat.	$V_{i\text{ nom}}$ $I_{o\text{ nom}} \leftrightarrow 1/2 I_{o\text{ nom}}$ IEC/EN 61204			± 250			mV
$t_{o\text{ d}}$		Recovery time				1			ms
α_{V_o}	Temperature coefficient $\Delta V_o / \Delta T_C$	$V_{i\text{ min}}$ to $V_{i\text{ max}}$ (0.1 to 1) $I_{o\text{ nom}}$			± 0.02			± 0.02	%/K

- ¹ SR Models -8RG (synchr. rectifier) have a minimum case and operating temperature of $-25\text{ }^\circ\text{C}$. If the revision is BA (or later), it is $-40\text{ }^\circ\text{C}$.
- ² The current limit is primary side controlled. In the event of a sustained overload condition the thermal protection may cause the converter to shut down (restart after cooling down).
- ³ The overvoltage protection is via a primary side second regulation loop. It is not tracking with R control.
- ⁴ BW = 20 MHz
- ⁵ Measured with a probe according to EN 61204
- ⁶ $C_{o\text{ ext}}$ is limited to 3000 μ F, if $V_i > 125\text{ V}$ or $T_A < 25\text{ }^\circ\text{C}$

Table 7b: Output data for -05-8R and -0503-8R models; general conditions as in table 7a

Output		5.1 V			5.1/3.3 V			Unit		
Characteristics	Conditions	min	typ	max	min	typ	max			
V_{O1}, V_{O1} V_{O2}	Output voltage	$V_{i\ nom}$ $I_o = 0.5 I_{o\ nom}$			5.05	5.15		5.0 3.13	5.12 3.46	V
$I_{o\ nom}$	Output current ¹	$V_{i\ min} - V_{i\ max}$			2.3		2×1.35 1.6 ⁴		A	
	20IMX				2.7		2×1.6 2.0 ⁴			
	24IMS/48IMS				2.5		2×1.5 1.8 ⁴			
I_{oL}, I_{o1L} I_{o2L}	Current limit ²	$V_{i\ nom}$ $V_{o1} \leq 93\% V_{o\ nom}$			3.2		2.7 3.8		A	
	20IMX				3.5		3.0 3.8			
	24IMS/48IMS				3.6		2.9 4.0			
I_{oL}/I_{o1L} I_{o2L}	40IMX/110IMY									
ΔV_o	Line/load regulation	$V_{i\ min} - V_{i\ max}$, (0.1 - 1) $I_{o\ nom}$			± 0.5		-		%	
	5.1 V				-		+3 / -5			
	5.1 V				-		± 4.5			
	3.3 V									
$V_{O1/2}$	Output voltage noise	$V_{i\ min} - V_{i\ max}$ $I_o = I_{o\ nom}$			5 70		80		mV _{pp}	
					6 40		40			
V_{oL}	Output overvoltage limit ⁷				115		130		%	
$C_{o\ ext}$	Admissible capacitive load				0		4000		μF	
$V_{o\ d}$	Dynamic load regulation	Voltage deviat.			$V_{i\ nom}$ $I_{o\ nom} \leftrightarrow 1/2 I_{o\ nom}$ IEC/EN 61204		± 250		mV	
$t_{o\ d}$		Recovery time			1		1		ms	
α_{V_o}	Temperature coefficient $\Delta V_o/\Delta T_C$	$V_{i\ min} - V_{i\ max}$ (0.1 - 1) $I_{o\ nom}$			± 0.02		± 0.02		%/K	

- 1 Flexible load distribution: I_o max for one of the 2 outputs; however the total load should not exceed $P_{o\ nom}$ specified in the table *Model Selection*.
- 2 The current limit is primary-side controlled.
- 3 For -0503-models: total capacitive load of both outputs.
- 4 For -0503-models: Conditions for specified output. Other output loaded with constant current $I_o = 0.5 I_{o\ nom}$.
- 5 BW = 20 MHz
- 6 Measured with a probe according to EN 61204
- 7 The overvoltage protection is via a primary side second regulation loop. It is not tracking with R control.

Table 7c: Output data for double-output models; general conditions as in table 7a

Output				2 × 5 V			2 × 12 V			2 × 15 V			2 × 24 V			Unit
Characteristics			Conditions	min	typ	max	min	typ	max	min	typ	max	min	typ	max	
V _{o1}	Output 1	24IMS/48IMS	V _{i nom} I _o = 0.5 I _{o nom}	4.95		5.05	11.88		12.12	14.85		15.15	23.70		24.30	V
		other models		4.95		5.05	11.90		12.10	14.88		15.12	23.80		24.20	
V _{o2}	Output 2	24IMS/48IMS	V _{i nom} I _o = 0.5 I _{o nom}	4.94		5.06	11.84		12.16	14.80		15.20	23.64		24.36	V
		other models		4.94		5.06	11.88		12.12	14.85		15.15	23.75		24.25	
I _{o nom}	Output current ¹	20IMX	V _{i min} – V _{i max}	2 × 1.3		2 × 0.65		2 × 0.50		2 × 0.32						A
		other models		2 × 1.4		2 × 0.70		2 × 0.56		2 × 0.35						
I _{oL}	Current limit ^{2,4}	20IMX	V _{i nom} V _{o1} ≤ 93% V _{o nom}	3.0		1.6		1.3		0.85						
		24IMS/48IMS		3.5		1.9		1.6		0.95						
		40IMX/110IMY		3.2		1.7		1.4		0.90						
ΔV _{o1}	Line/load regulation ⁸ output 1		V _{i min} – V _{i max} , I _{o nom}	±1		±1		±1		±1				%		
ΔV _{o2}	output 2		V _{i nom} , (0.1 – 1) I _{o nom}	±3		±3		±3		±3				%		
V _{o1/2}	Output voltage noise		V _{i min} – V _{i max} I _o = I _{o nom}	80		120		150		240				mV _{pp}		
				40		60		70		120						
V _{oL}	Output overvoltage limit ^{7,8}		Min. load 1%	115	130	115	130	115	130	115	130	115	130	%		
C _{o ext}	Admissible capacitive load ³			0	4000	0	680	0	470	0	180	0	180	μF		
V _{o d}	Dynamic load regulation	Voltage deviat.	V _{i nom} I _{o nom} ↔ 1/2 I _{o nom}	±250		±300		±300		±600				mV		
t _{o d}		Recovery time		1		1		1		1				ms		
α _{Vo}	Temperature coefficient ΔV _o /ΔT _C		V _{i min} – V _{i max} (0.1 – 1) I _{o nom}	±0.02		±0.02		±0.02		±0.02				% / K		

¹ Flexible load distribution: Each output of double-output models is capable of delivering 75% of the total output power; however the total load should not exceed P_{o nom} specified in the table Model Selection.

² The current limit is primary-side controlled.

³ Measured with both outputs connected in parallel.

⁴ Conditions for specified output. Other output loaded with constant current I_o = 0.5 I_{o nom}.

⁵ BW = 20 MHz

⁶ Measured with a probe according to EN 61204

⁷ The overvoltage protection is via a primary side second regulation loop, not tracking with Trim or R control.

⁸ At start-up occurs a short overshoot at the output.

Thermal Considerations

If a converter, mounted on a PCB, is located in free, quasi-stationary air (convection cooling) at the indicated maximum ambient temperature $T_{A\max}$ (see table *Temperature specifications*) and is operated at its nominal input voltage and output power, the case temperature measured at the measuring point of case temperature T_C (see *Mechanical Data*) will approach the indicated value $T_{C\max}$ after the warm-up phase. However, the relationship between T_A and T_C depends heavily on the conditions of operation and integration into a system. The thermal conditions are influenced by input voltage, output current, airflow, temperature of surrounding components and surfaces, and the properties of the printed circuit board. $T_{A\max}$ is therefore only an indicative value.

Caution: The case temperature T_C measured at the measuring point of case temperature T_C (see *Mechanical Data*) may under no circumstances exceed the specified maximum value. The installer must ensure that under all operating conditions T_C remains within the limits stated in the table *Temperature specifications*.

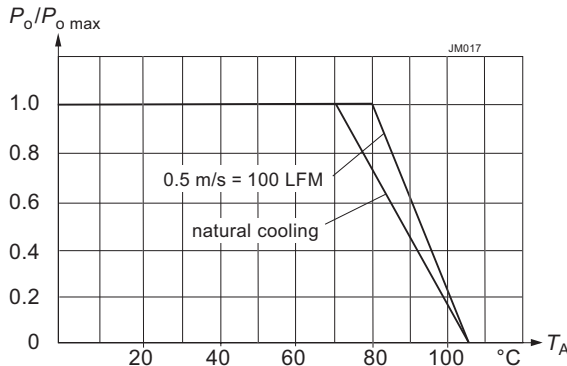

Fig. 7
 Maximum output power versus ambient temperature

Overtemperature Protection

The converters are protected from possible overheating by means of an internal temperature monitoring circuit. It shuts down the converter above the internal temperature limit, and attempts to automatically restart in short intervals. This feature helps protect against excessive internal temperatures, which could occur during heavy overload conditions.

Output Overvoltage Protection

The output of single-output models as well as -0503- and -05-05-models are protected against overvoltage by a second control loop. In the event of an overvoltage on one of the outputs, the converter will shut down and attempt to restart in short intervals.

Double-output models (except -0503- and -05-05-models) are protected against overvoltage by a Zener diode across the second output. Under worst case conditions the Zener diode will become a short circuit. Since with double-output models both outputs track each other, the protection diode is only provided in one of the outputs. The main purpose of this feature is to protect against possible overvoltage, which could occur due to a failure in the control logic. This protection circuit is not designed to withstand externally applied overvoltages.

Short Circuit Behavior

The current limit characteristic shuts down the converter, whenever a short circuit is applied to its output. It acts self-protecting, and automatically recovers after removal of the overload condition (hiccup mode).

Parallel and Series Connection

The outputs of one or several single- or double-output models

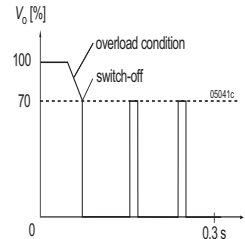

Fig. 8
 Overload switch-off (hiccup mode); typical values

can be connected in series without any precautions, taking into consideration that the highest output voltage should remain below 42 V to ensure that the output remains SELV.

Both outputs of the same converter with equal voltage (e.g. 5 V / 5 V) can be connected in parallel and will share their output currents equally. Parallel operation of single or double outputs of two or more converters with the same output voltage may cause start-up problems at initial start-up. This is only advisable in applications, where one converter is able to deliver the full load current as, for example, required in true redundant systems.

Note: If the 2nd output of double-output models (except 0503) is not used, connect it in parallel to the 1st output.

Typical Performance Curves

General conditions:

- $T_A = 25\text{ °C}$, unless T_C is specified.
- Shutdown pin left open-circuit.
- Trim or R input not connected.

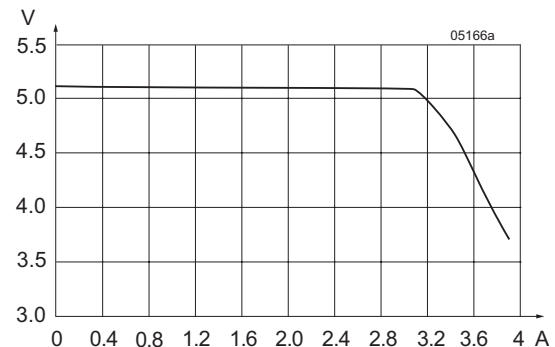

Fig. 9
 V_o versus I_o (typ) of converters with $V_o = 5.1\text{ V}$ (110IMY15-05-8R)

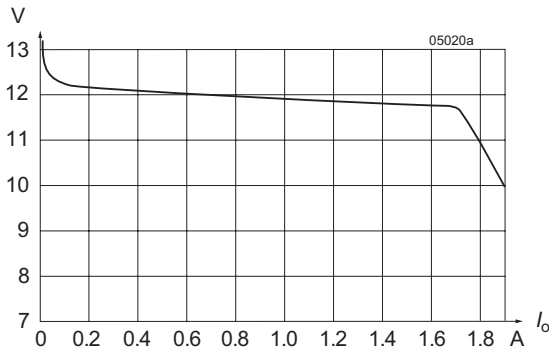

Fig. 10
V_o versus I_o (typ.) of double-output models (2 x 12 V), with both outputs in parallel (110IMY15-12-12-8)

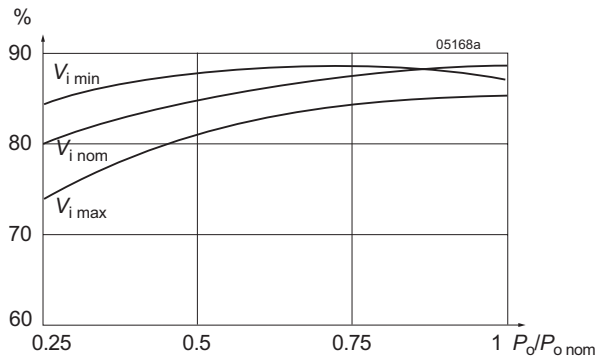

Fig. 12b
Efficiency versus input voltage and load. Typical values (110IMY15-12-12-8)

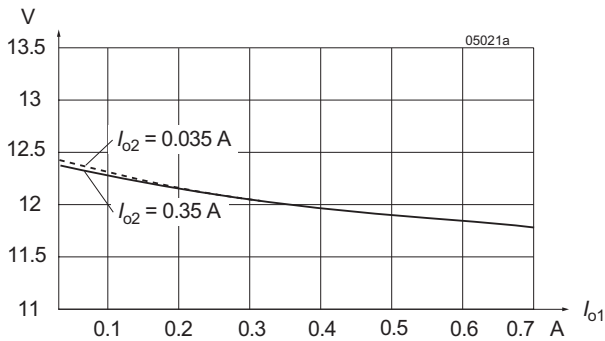

Fig. 11
Cross load regulation V_{o1} versus I_{o1} (typ.) for various I_{o2} (2 x 12 V).

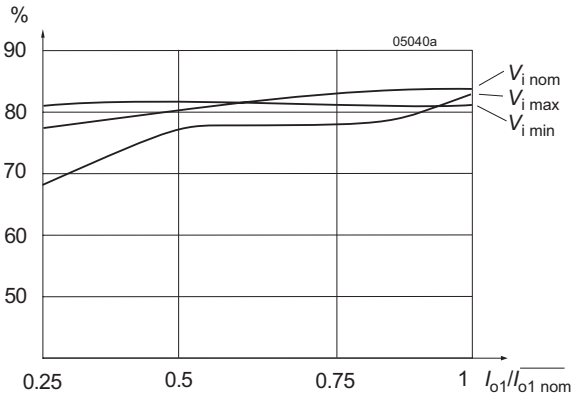

Fig. 12c
Efficiency versus input voltage and load. Typical values (48IMS15-12-12-9)

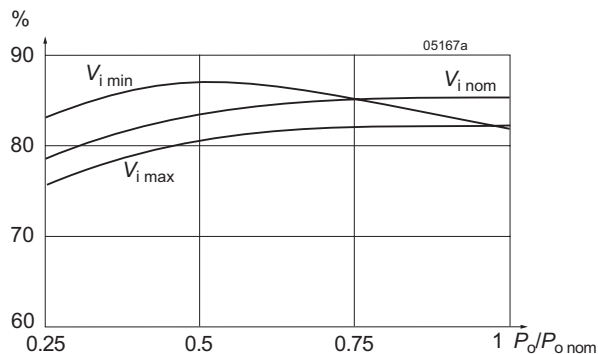

Fig. 12a
Efficiency versus input voltage and load. Typical values (40IMX15-12-12-8).

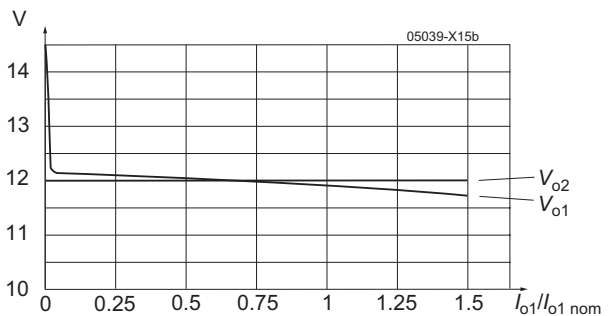

Fig. 13
Flexible load distribution on double-outputs models with option R (110IMY15-12-12-8R): Load variation from 0 to 150% of I_{o1} nom on output 1; output 2 loaded with 50% of I_{o2} nom.

Auxiliary Functions

Shutdown Function

The outputs of the converters may be enabled or disabled by means of a logic signal (TTL, CMOS, etc.) applied to the shut-down pin. If this function is not required, the shut-down pin should be left open-circuit.

- Converter operating: 2.0 to 20 V
- Converter disabled: -10 to +0.7 V

Adjustable Output Voltage

- R input for single-output models and -0503-models
- Trim input for double-output models

As a standard feature, the single- and double-output models offer adjustable output voltage(s) by using the control input R or Trim. If the control input is left open-circuit, the output voltage is set to $V_{o\text{ nom}}$. For output voltages $V_o > V_{o\text{ nom}}$, the minimum input voltage $V_{i\text{ min}}$ (see *Electrical Input Data*) increases proportionally to $V_o/V_{o\text{ nom}}$.

Single-output models with synchronous rectifier (G):

The R input is referenced to the secondary side of the converter. Adjustment of the output voltage is possible by means of an external resistor connected between the R pin and either V_{o+} or V_{o-} .

Note: For models with synchronous rectifier the logic for V_o adjustment differs from other models with R input.

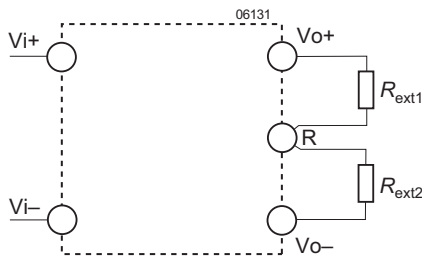

Fig. 14
Output voltage control for single-output models with synchronous rectifier.

Table 8: V_o versus V_{ext} approximate values

$V_{o\text{ nom}}$ [V]	Typ. values of R_{ext1}		Typ. values of R_{ext2}	
	V_o [% of $V_{o\text{ nom}}$]	R_{ext1} [kΩ]	V_o [% of $V_{o\text{ nom}}$]	R_{ext2} [kΩ]
3.3	90	0.47	100	∞
	95	2.7	105	15
	100	∞	110	6.8
5.1	90	3.3	100	∞
	95	8.2	105	9.1
	100	∞	110	3.9

All other models fitted with R-input:

The R input is referenced to the secondary side of the converter. Adjustment of the output voltage is possible by means of either an external resistor or a voltage source.

a) Adjustment by means of an external resistor R_{ext} .

Depending upon the value of the required output voltage, the resistor shall be connected:

either: Between the R pin and V_{o-} to achieve an output voltage adjustment range of $V_o \approx 80$ to 100 % of $V_{o\text{ nom}}$.

$$R_{\text{ext1}} \approx 4 \text{ k}\Omega \cdot \frac{V_o}{V_{o\text{ nom}} - V_o}$$

or: Between the R pin and V_{o+} to achieve an output voltage range of $V_o \approx 100$ to 105 % of $V_{o\text{ nom}}$.

$$R_{\text{ext2}} \approx 4 \text{ k}\Omega \cdot \frac{(V_o - 2.5\text{V})}{2.5 \text{ V} \cdot (V_o/V_{o\text{ nom}} - 1)}$$

b) Adjustment by means of an external voltage V_{ext} between V_{o-} and R pin.

The control voltage range is 1.96 to 2.62 V and allows for adjustment in the range of $V_o \approx 80$ to 105 % of $V_{o\text{ nom}}$.

$$V_{\text{ext}} \approx \frac{V_o \cdot 2.5 \text{ V}}{V_{o\text{ nom}}}$$

Attempting to adjust the output below this range will cause the converter to shut down (hiccup mode).

Note: Applying an external control voltage $>2.75 \text{ V}$ may damage the converter.

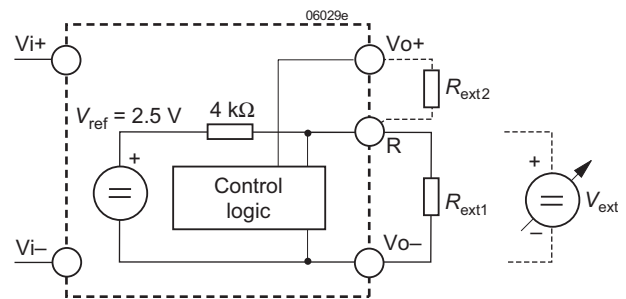

Fig. 15
Output voltage control for single-output models, -0503-models, and double-output models by means of the R input.

Double-output models with Trim input:

The Trim input is referenced to the primary side. The figure below shows the topology. Adjustment is possible through either an external resistor or an external voltage source V_{ext} .

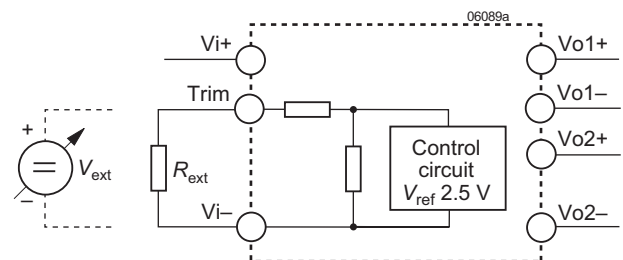

Fig. 16
Output voltage control for double-output models (with Trim input) by means of the Trim input.

a) Adjustment by means of an external resistor R_{ext} :

Programming of the output voltage by means of an external resistor R_{ext} is possible within 100 to 105% of $V_{o\ nom}$. R_{ext} should be connected between the Trim pin and V_{i-} . Connection of R_{ext} to V_{i+} may damage the converter. The table below indicates suitable resistor values for typical output voltages under nominal conditions ($V_{i\ nom}$, $I_o = 0.5 I_{o\ nom}$) with either parallel-connected outputs or equal-load conditions on both outputs.

Table 9a: R_{ext} for $V_o > V_{o\ nom}$;
 approximate values ($V_{i\ nom}$, $I_{o1,2} = 0.5 I_{o1/2\ nom}$)

V_o [% $V_{o\ nom}$]	R_{ext} [k Ω]
105 to 108 (107 typically)	0
105	1.5
104	5.6
103	12
102	27
101	68
100	∞

b) Adjustment by an external voltage source V_{ext} :

For programming the output voltage in the range 75 to 105% of $V_{o\ nom}$, a source V_{ext} (0 to 20 V) is required, connected between the Trim pin and V_{i-} . The table below indicates values V_o versus V_{ext} (nominal conditions $V_{i\ nom}$, $I_o = 0.5 I_{o\ nom}$), with either parallel-connected outputs or equal load conditions on both outputs. Applying a control voltage >20 V will set the converter into a hiccup mode. Direct paralleling of the Trim pins of parallel connected converters is possible.

Table 9b: V_o versus V_{ext} for $V_o = 75$ to 105% $V_{o\ nom}$;
 typical values ($V_{i\ nom}$, $I_{o1/2} = 0.5 I_{o1/2\ nom}$)

V_o [% $V_{o\ nom}$]	V_{ext} [V]
≥ 105	0
102	1.6
95	4.5
85	9
75	13

Electromagnetic Compatibility (EMC)

A suppressor diode together with an input filter forms an effective protection against high input transient voltages, which

typically occur in many installations, but especially in battery-driven mobile applications.

Electromagnetic Immunity

Table 10: Immunity type tests

Phenomenon	Standard	Class Level	Coupling mode ²	Value applied	Waveform	Source Imped.	Test procedure	In oper.	Perf. crit. ³
Electrostatic discharge to case	IEC/EN 61000-4-2	2	contact discharge (R pin open)	4000 V_p	1/50 ns	330 Ω 150 pF	10 positive and 10 negative discharges	yes	B
		3	air discharge (R pin open)	8000 V_p					
Electromagnetic field	IEC/EN 61000-4-3	χ^5 3^6	antenna	20 V/m ⁵ 3 V/m ⁶	AM 80% 1 kHz	n.a.	80 to 1000 MHz	yes	A
	ENV 50204	3	antenna	10 V/m	PM, 50% duty cycle, 200 Hz repetition frequ.	n.a.	900 MHz	yes	A
Electrical fast transients/burst	IEC/EN 61000-4-4	3^4	direct +i/-i	2000 V_p ⁴	bursts of 5/50 ns 5 kHz rep. rate transients with 15 ms burst duration and a 300 ms period	50 Ω	60 s positive 60 s negative transients per coupling mode	yes	A
Surges	IEC/EN 61000-4-5	2 3^1	+i/-i	1000 V_p 2000 V_p ¹	1.2/50 μ s	2 Ω 18 μ F	5 pos. and 5 neg. surges	yes	B
RF conducted immunity	IEC/EN 61000-4-6	3 2^6	+i/-i	10 VAC 3 VAC ⁶	AM modulated 80%, 1 kHz	150 Ω	0.15 to 80 MHz	yes	A

¹ External components required; see Fig. 6 and table 6.

² i = input, o = output.

³ A = normal operation, no deviation from specs., B = temporary deviation from specs. possible.

⁴ Corresponds to the railway standard EN 50121-3-2:2006, table 9.3.

⁵ Corresponds to the railway standard EN 50121-3-2:2006, table 9.1.

⁶ Valid for 24IMS15 and 48IMS15

Conducted Emissions

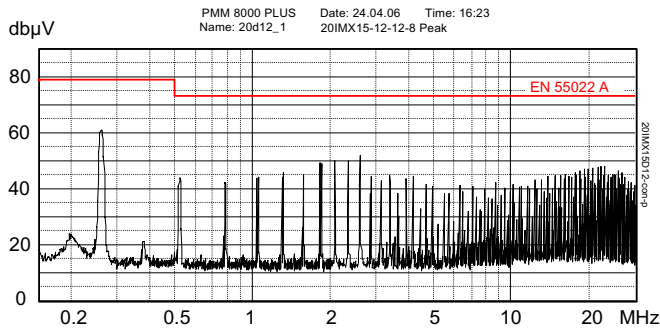

Fig. 17a
 Typ. disturbance voltage (peak) at pos. input according to EN 55011/032, measured at $V_{i\text{nom}}$ and $I_{o\text{nom}}$. Output leads 0.1 m, twisted, input capacitors see table 11 (20IMX15-12-12-8)

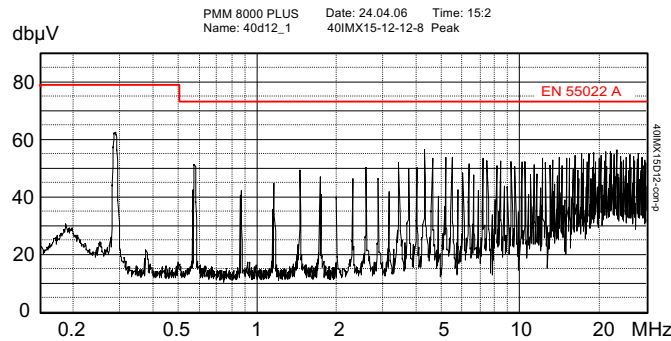

Fig. 17b
 Typ. disturbance voltage (peak) at pos. input according to EN 55011/032, measured at $V_{i\text{nom}}$ and $I_{o\text{nom}}$. Output leads 0.1 m, twisted, input capacitors see table 11 (40IMX15-12-12-8)

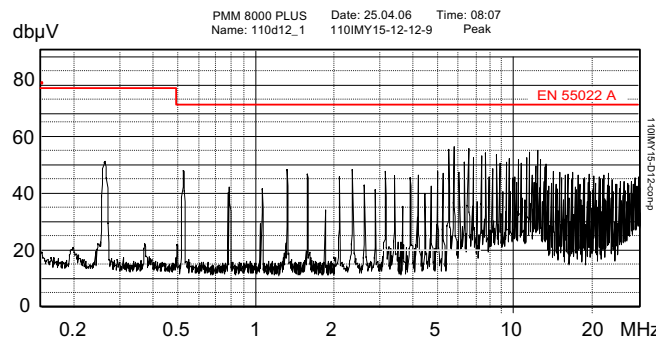

Fig. 17c
 Typ. disturbance voltage (peak) at pos. input according to EN 55011/032, measured at $V_{i\text{nom}}$ and $I_{o\text{nom}}$. Output leads 0.1 m, twisted, input capacitors see table 11 (110IMY15-12-12-8)

Table 11: External capacitors across the input to comply with EN 55011/EN 55032, Class A, conducted; see fig. 17.

Model	Ceramic ML	Electrolytic capacitor
20IMX15, 24IMS15	0.47 $\mu\text{F}/50\text{ V}$	220 $\mu\text{F}/50\text{ V}$
40IMX15, 48IMS15	0.33 $\mu\text{F}/100\text{ V}$	220 $\mu\text{F}/100\text{ V}$
110IMY15	0.15 $\mu\text{F}/200\text{ V}$	4.7 $\mu\text{F}/200\text{ V}$

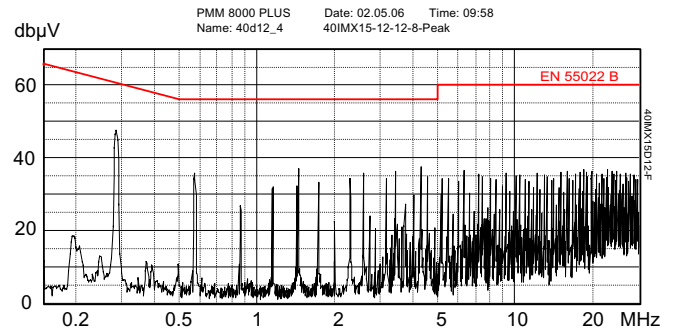

Fig. 18
 Typ. disturbance voltage (peak) at input according to EN 55011/022, measured at $V_{i\text{nom}}$ and $I_{o\text{nom}}$. Output leads 0.1 m, twisted, input filter as in fig. 19 (40IMX15-12-12-8)

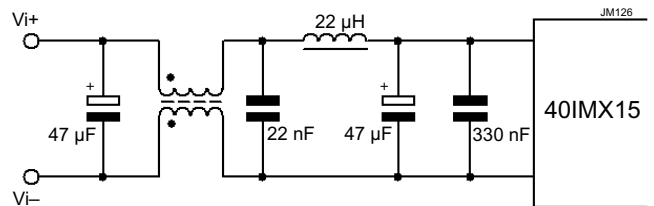

Fig. 19
 Example for external circuitry to comply with EN 55011/ EN 55032, Class B, conducted.
 This filter was designed for a 40IMX15-12-12-8. All capacitors are rated to 100 V, the chokes to 1.5 A.

Immunity to Environmental Conditions

Table 12: Mechanical and climatic stress

Test Method		Standard	Test Conditions		Status
Cab	Damp heat steady state	IEC/EN 60068-2-78 MIL-STD-810D sect. 507.2	Temperature: Relative humidity: Duration:	40 ±2 °C 93 +2/-3 % 56 days	Converter not operating
Ea	Shock (half-sinusoidal)	IEC/EN 60068-2-27 MIL-STD-810D sect. 516.3	Acceleration amplitude: Bump duration: Number of bumps:	50 g _n = 490 m/s ² 11 ms 18 (3 each direction)	Converter operating
Fc	Vibration (sinusoidal)	IEC/EN 60068-2-6	Acceleration amplitude: Frequency (1 Oct/min): Test duration:	0.35 mm (10 to 60 Hz) 5 g _n = 49 m/s ² (60 to 2000 Hz) 10 to 2000 Hz 7.5 h (2.5 h each axis)	Converter operating
Fda	Random vibration wide band reproducibility high	IEC/EN 60068-2-35	Acceleration spectral density: Frequency band: Acceleration magnitude: Test duration:	0.05 g _n ² /Hz 20 to 500 Hz 4.9 g _{n rms} 3 h (1 h each axis)	Converter operating
--	Salt mist test sodium chloride (NaCl) solution	EN 50155:2007, clause 12.2.10 class ST2	Temperature: Duration:	35 ±2 °C 16 h	Converter not operating

Temperatures

Table 14: Temperature specifications

Valid for air pressure of 800 to 1200 hPa (800 to 1200 mbar)

Temperature			-9		-8		Unit
Characteristics	Conditions	min	max	min	max		
T _A Ambient temperature	Operational ¹	-40	71	-40 ^{2, 3}	85	°C	
T _C Case temperature		-40	95	-40 ^{2, 3}	105		
T _S Storage temperature	Non operational	-55	85	-55	85		

¹ See *Thermal Considerations*

² Start-up at -55 °C, except models with synchronous rectifier ^{SR}

³ -25 °C for all models with synchronous rectifier ^{SR} with Revision < BA.

Reliability

Table 13: MTBF

Model	Standard	Ground Benign	Ground Fixed		Ground Mobile	Unit
		T _C = 40 °C	T _C = 40 °C	T _C = 70 °C	T _C = 50 °C	
20IMX15-12-12-8	MIL-HDBK-217F	697 000	366 000	229 000	312 000	h
20IMX15-15-15-8	Belcore	2 345 000	1 172 000	632 000	317 000	
48IMS15-05-05-9	MIL-HDBK-217F	535 000	283 000	179 000	245 000	
110IMY15-05-8R	MIL-HDBK-217F	485 000	255 000	167 000	223 000	
	Belcore	1 547 000	774 000	394 000	206 000	

Mechanical Data

Dimensions in mm (inches). Tolerances ± 0.3 mm, unless otherwise noted.

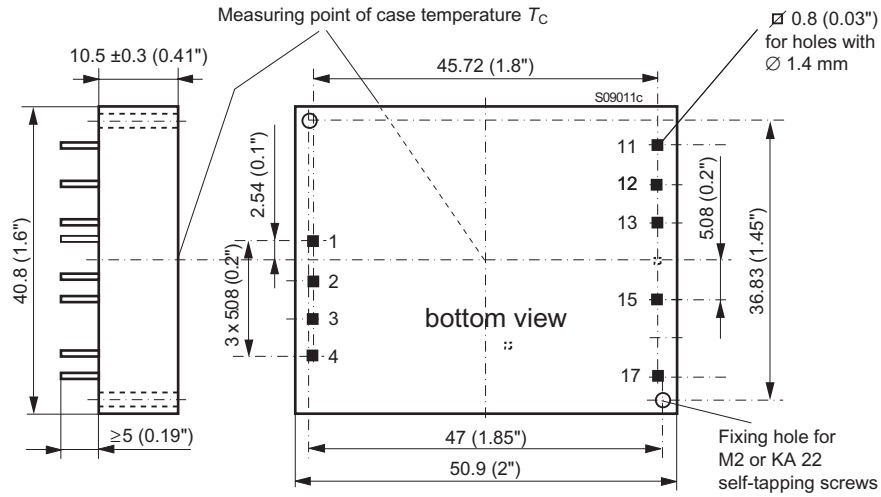

Fig. 20
Case IMX15, IMS15, IMY15
Material: Fortron 1140L6
Weight: <35 g

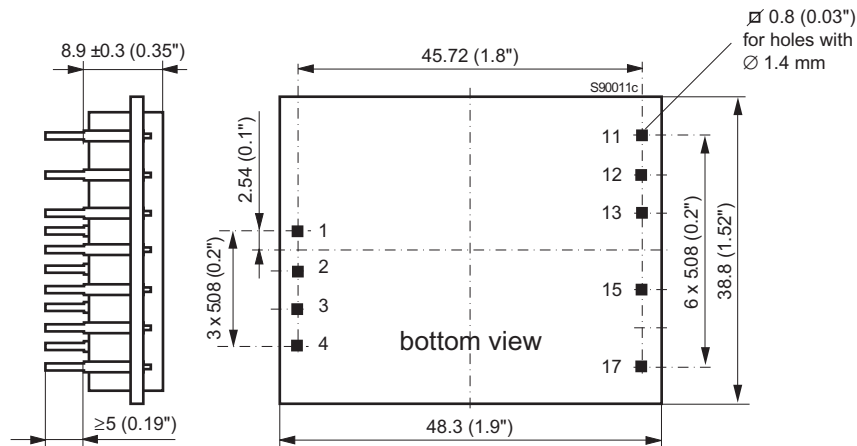

Fig. 21
Open frame (option Z)

Safety and Installation Instructions

Pin allocation

Table 15: Pin allocation

Pin	Standard and Option Z		
	single	double	-0503-
1	Vi+	Vi+	Vi+
2	Vi-	Vi-	Vi-
3	-	Trim	n.c.
4	\overline{SD}	\overline{SD}	\overline{SD}
5	-	-	-
6	-	-	-
11	-	Vo1+	Vo2+
12	-	Vo1-	Go
13	Vo+	Vo2+	Vo1+
15	Vo-	Vo2-	Go
17	R	n.c.	R

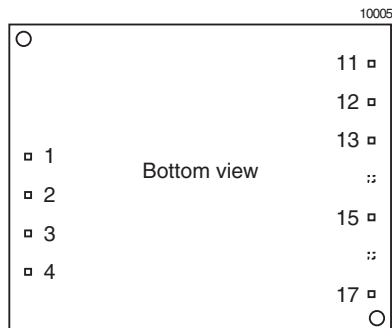

Fig. 22
Footprint

Installation Instructions

Installation must strictly follow the national safety regulations in compliance with the enclosure, mounting, creepage, clearance, casualty, markings and segregation requirements of the end-use application.

The converter must be connected to a secondary circuit.

Do not open the converter.

Ensure that a converter failure (e.g., by an internal short-circuit) does not result in a hazardous condition.

Input Fuse

To prevent excessive current flowing through the input supply lines in case of a malfunction an external fuse should be installed in a non-earthed input supply line; see *table 4*.

Standards and Approvals

The converters are approved according to IEC 60950-1 and UL/CSA 60950-1 2nd Edition. 110IMY models are fitted with a CE mark.

The converters have been evaluated for:

- Building in
- Supplementary insulation input to output, based on their maximum input voltage (IMX15, IMS15)
- Reinforced insulation input to output, based on their maximum input voltage (IMY15 models)
- Pollution degree 2 environment (not option Z)
- Connecting the input to a secondary circuit subject to a maximum transient rating of 1500 V (IMX15, IMS15)
- Connecting the input to a secondary circuit subject to a maximum transient rating of 2500 V (IMY15)

The converters are subject to manufacturing surveillance in accordance with the above mentioned UL standards and with ISO9001:2008.

Railway Applications

To comply with railway standards, all components are coated with a protective lacquer (except option Z).

Protection Degree and Cleaning Liquids

The protection degree of the converters is IP 40, except open-frame models (option Z).

In order to avoid possible damage, any penetration of cleaning fluids should be prevented, since the power supplies are not hermetical sealed.

However, open-frame models (option Z) leave the factory unlacquered; they may be lacquered by the customer, for instance together with the mother board. Cleaning liquids are not permitted – except washing at room temperature with isopropyl alcohol. If necessary, the mother board must be cleaned, before fitting the open-frame converter.

Note: Cleaning liquids may damage the adhesive joints of the ferrite cores.

Isolation

The electric strength test is performed in the factory as routine test in accordance with EN 50514 and IEC/EN 60950. The Company will not honor any warranty claims resulting from incorrectly executed electric strength field tests.

Table 16: Electric strength test voltages

Characteristic	Input to output			Output to Unit	Unit
	IMX15	IMY15	output		
Factory test ≥ 1 s	1.2	1.5 ¹	3.0	0.1	kVAC
Equivalent DC voltage	(1.7)	(2.1)	(4.2)	0.15	kVDC
Insulation resistance at 500 VDC	>100	>100	>100	-	M Ω
Partial discharge extinction voltage	Consult the Company			-	kV

¹ 1.5 kVAC according to IEC 60950, sect. 6.2, Telecom equipment; type test with 1.5 kVAC / 60 s (IEE 802.3). IMX15 units produced before 2013 were tested only with 1.2 kVAC.

² The test voltage between outputs is not applied as routine test.

Description of Options

Table 17: Survey of options

Option	Function of option	Characteristic
-9	Temperature range, NFND	See table <i>Temperatures specifications</i>
i	Inhibit	Replaces the shutdown function with inverted logic
Z	Open frame	See <i>Mechanical Data</i>

Option -9 versus -8

IMX15 and IMY15 models with -9 (not for new designs) have a limited temperature range. Standard models with suffix -8 are rated up to $T_A = 85\text{ }^\circ\text{C}$; see table *Temperature specifications*.

Option i: Inhibit

Replaces the shut-down function with inverted logic.

The output(s) of the converter may be enabled or disabled by

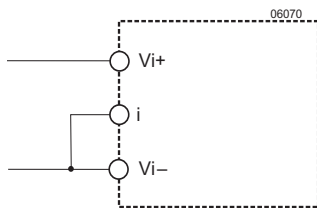

Fig. 23

If the inhibit function is not used, the inhibit pin should be connected to V_i- .

means of a logic signal (TTL, CMOS, etc.) applied to the inhibit pin. No output voltage overshoot will occur, when the converter is turned on. If the inhibit function is not required, the inhibit pin should be connected to V_i- to enable the output (active low logic, fail safe).

Voltage on pin i:

Converter operating: $-10\text{ V to }0.8\text{ V}$

Converter inhibited: $2.4\text{ V to }V_{i\text{ max}} (<75\text{ V})$ or pin i left open-circuit.

Option Z

Open frame and not lacquered. This option can be chosen for mounting onto a mother board, which is subject to be lacquered. See *Protection Degree and Cleaning Liquids* (page 18).

Option G or -G

Products RoHS-compliant for all 6 substances. See *RoHS-Compliant Models* (page 3) for the correct denotation.

Accessories

Supports are available for chassis mounting CMBIMX15 (HZZ00626) and for DIN-rail mounting DMBIMX15 (HZZ00625). They exhibit the connectors and allow for placing different external components. For details see our Mounting Supports Data Sheet BCD20007 on our website.



Fig. 24
DIN-rail mounting support DMBIMX15

NUCLEAR AND MEDICAL APPLICATIONS - These products are not designed or intended for use as critical components in life support systems, equipment used in hazardous environments, or nuclear control systems.

TECHNICAL REVISIONS - The appearance of products, including safety agency certifications pictured on labels, may change depending on the date manufactured. Specifications are subject to change without notice.

Copyright © 2017, Bel Power Solutions Inc. All rights reserved.

belfuse.com/power-solutions