

Powered by



MSV 400 ▶ 2V 415Ah

MSV 400 is a long service life battery up to 15 years expected life under normal float charge. As with all CSB batteries, all are rechargeable, highly efficient, leak proof and maintenance free.



CSB-manufactured **VRLA** (Absorbent Glass Mat type) batteries are UL-recognized components under UL1989.

CSB is also certified by ISO 9001 and ISO 14001.

► Specification

Cells Per Unit	1
Voltage Per Unit	2
Capacity	415Ah @ 10hr-rate to 1.80V per cell @25 °C (77°F)
Weight	Approx. 24.9 kg(54.90 lbs)
Maximum Discharge Current	2400A(5sec)
Internal Resistance	Approx. 0.43 mΩ
Operating Temperature Range	Discharge: -20°C~50°C(-4°F~122°F) Charge: 0°C~40°C(32°F~104°F) Storage: -20°C~40°C(-4°F~104°F)
Nominal Operating Temperature Range	25°C±3°C(77°F±5°F)
Float Charging Voltage	2.23±0.02/Cell at 25 °C(77°F) Temp. Coefficient ±3.3mV/°C(±1.8mV/°F)
Recommended Maximum Charging Current Limit	120A
Equalization / Cycle Use Charging Voltage	2.35V Temps coefficient ±3.3mV/°C(±1.8mV/°F)
Terminal	Pb-Ca-Sn Alloy(L / Recessed Terminal)
Container Material	The container and cover are made of flame retardant plastics which meet ABS(UL 94-V0) specifications. The oxygen index level is higher than 28

► Dimensions :

Unit: mm (inch)

Overall Height (H)	Container height (h)	Length (L)	Width (W)
339±3 (13.35±0.12)	331±2.5 (13.03±0.10)	197±2 (7.76±0.08)	170±2 (6.69±0.08)

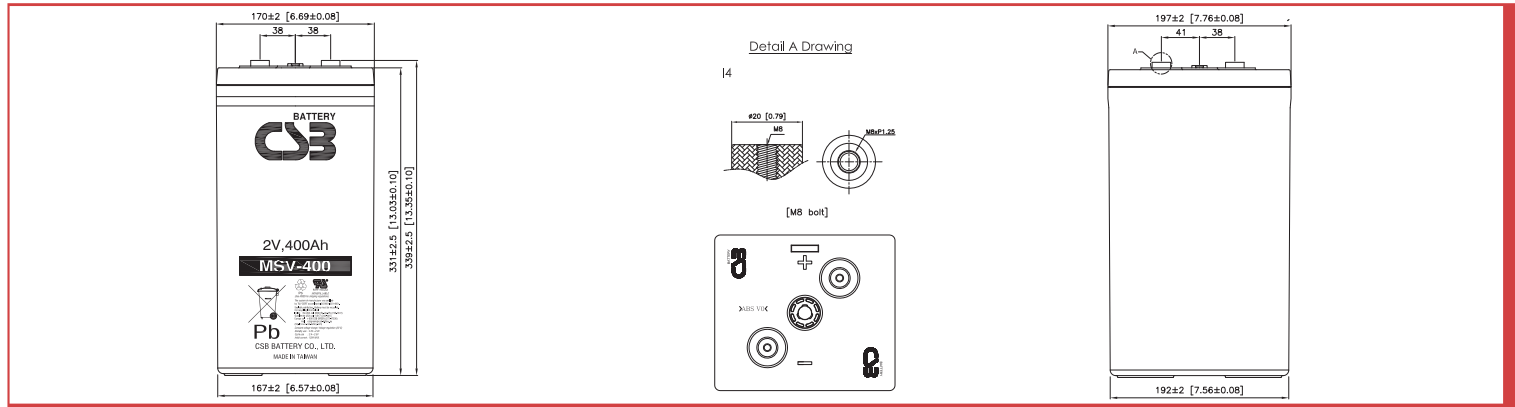

Constant Current Discharge Characteristics Unit:A (25°C, 77°F)

F.V/Time	15MIN	30MIN	60MIN	2HR	3HR	4HR	5HR	6HR	8HR	10HR
1.60V	586.3	424.8	259.0	158.0	116.2	93.3	77.3	66.2	52.0	43.0
1.67V	543.0	399.4	252.6	156.4	115.2	92.5	76.7	65.8	51.7	42.9
1.70V	516.6	384.9	248.2	155.2	114.6	92.1	76.4	65.5	51.5	42.7
1.75V	475.6	354.2	237.5	151.9	112.7	90.7	75.4	64.8	51.0	42.3
1.80V	428.3	313.1	222.1	145.8	109.3	88.2	73.5	63.3	50.0	41.6
1.83V	380.6	284.5	210.9	140.0	106.0	85.7	71.5	61.7	48.9	40.8

Constant Power Discharge Characteristics Unit:W (25°C, 77°F)

F.V/Time	15MIN	30MIN	60MIN	2HR	3HR	4HR	5HR	6HR	8HR	10HR
1.60V	884.1	732.9	474.4	291.7	212.3	169.4	142.4	123.8	99.2	83.5
1.67V	871.0	700.8	464.9	288.6	209.8	167.3	140.8	122.6	98.5	83.1
1.70V	862.3	679.3	458.3	286.9	209.1	167.0	140.6	122.4	98.3	83.0
1.75V	841.7	630.5	442.5	282.0	206.9	166.1	140.1	121.9	97.8	82.5
1.80V	754.9	565.8	419.9	272.8	202.8	164.4	139.0	120.8	96.8	81.5
1.83V	673.6	520.5	402.1	261.7	196.9	160.9	136.3	118.5	95.1	80.2

Ratings presented herein are subject to revision without notice. Please refer to www.csb-battery.com to confirm the latest version.

Expected Life V.S Operating Temperature

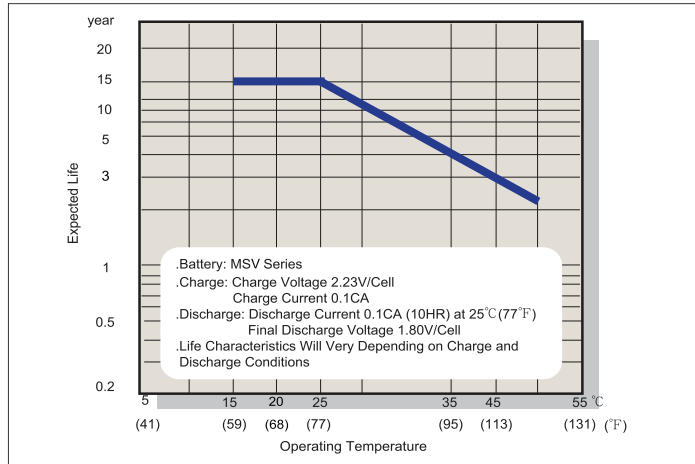

Typical Constant Voltage Charge Characteristics

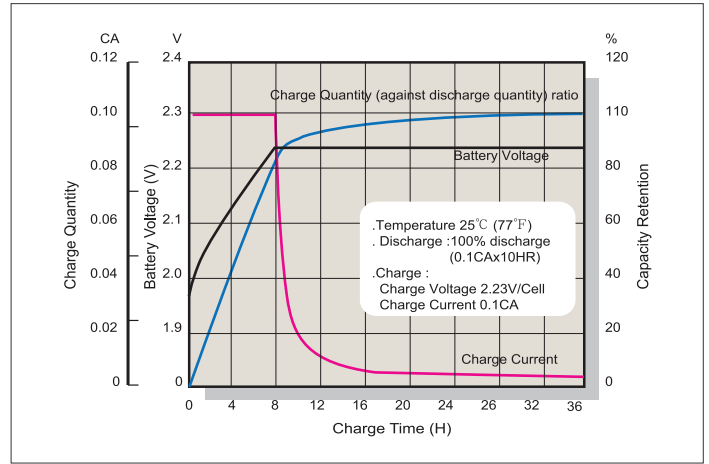

Capacity Retention Characteristics

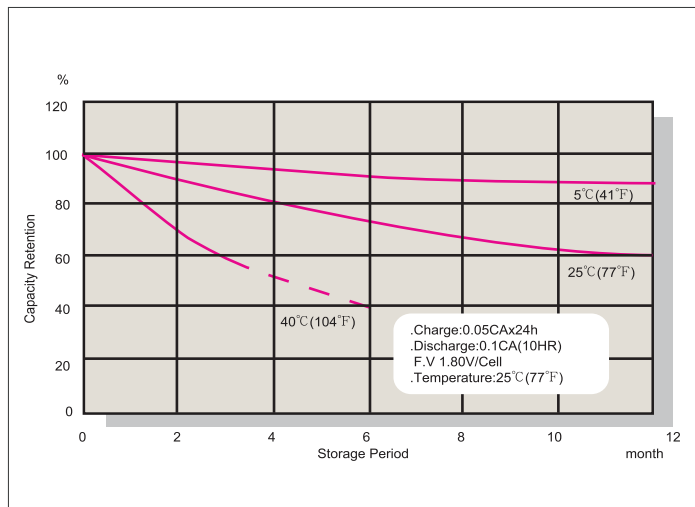

Discharge Characteristics

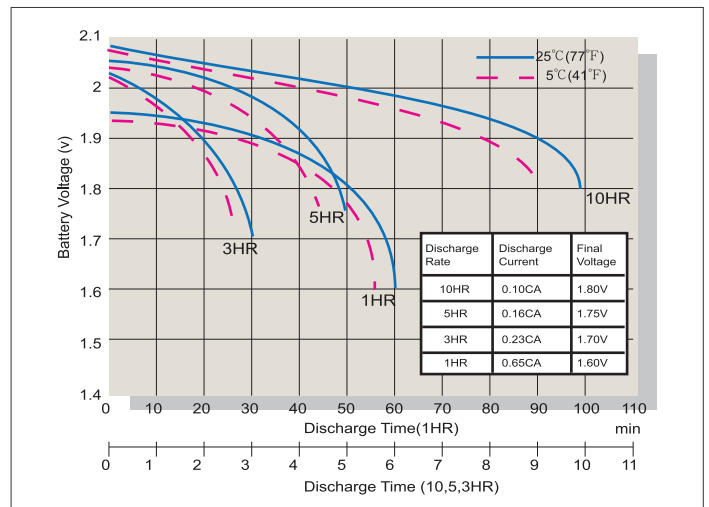

Oxygen Recombination Efficiency Chart

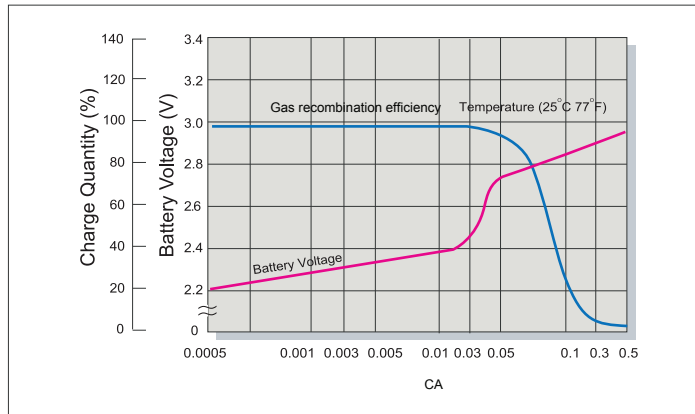

Terminal Voltage (V) and Discharge Time 25°C (77°F)

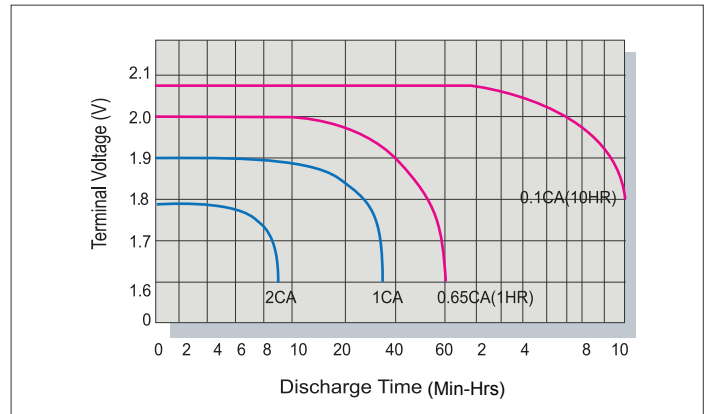

Charging Procedures

Application	Charge Voltage (V/Cell)			Max. Charge Current
	Temperature	Set Point	Allowable Range	
Standby	25°C (77°F)	2.23	2.21-2.25	0.3C

Discharge Current VS. Discharge Voltage

Discharge Current (A)	Final Discharge Voltage (V/Cell)
0.05C > A	1.90
0.15C > A ≥ 0.05C	1.80
0.20C > A ≥ 0.15C	1.75
0.40C > A ≥ 0.20C	1.70
A > 0.40C	1.60

Sales Office URL: WWW.CSB-BATTERY.COM

GLOBAL HQ
CSB BATTERY CO., LTD. (TAIWAN)
 Tel : +886-2-2880-5600
 Fax : +886-2-2888-3300
 mail : service@csb-battery.com.tw

BEIJING OFFICE. (CHINA)
CSB BATTERY TECHNOLOGIES (BEIJING) CO., LTD.
 Tel : +86-10-5820-5336/5338
 Fax : +86-10-58203053
 mail : chinasl@csb-battery.com

AMERICA HQ
CSB BATTERY TECHNOLOGIES INC. (U.S.A)
 Tel : +1-817-244-7777/1-(800)3-CSB-USA(272872)
 Fax : +1-817-244-4445
 mail : csb@csb-battery.com

SHANGHAI OFFICE. (CHINA)
CSB BATTERY LOGISTIC (SHANGHAI) CO., LTD.
 Tel : +86-21-5046-1622/5046-0833
 Fax : +86-21-5064-1046
 mail : chinasl@csb-battery.com

EUROPE HQ
CSB Battery Europe BV.
 Tel : +31(0)-180-418-140
 Fax : +31(0)-180-418-327
 mail : eurosales@csb-battery.eu

SHENZHEN OFFICE. (CHINA)
CSB BATTERY LOGISTIC (SHANGHAI) CO., LTD.
 Tel : +86-755-8831-6488/6396/6356
 Fax : +86-755-8831-6548
 mail : she@csb-battery.com.cn