

# Keysight N5393D

## PCI Express® 3.0 (Gen3) Software for Infiniium Oscilloscopes

Data Sheet

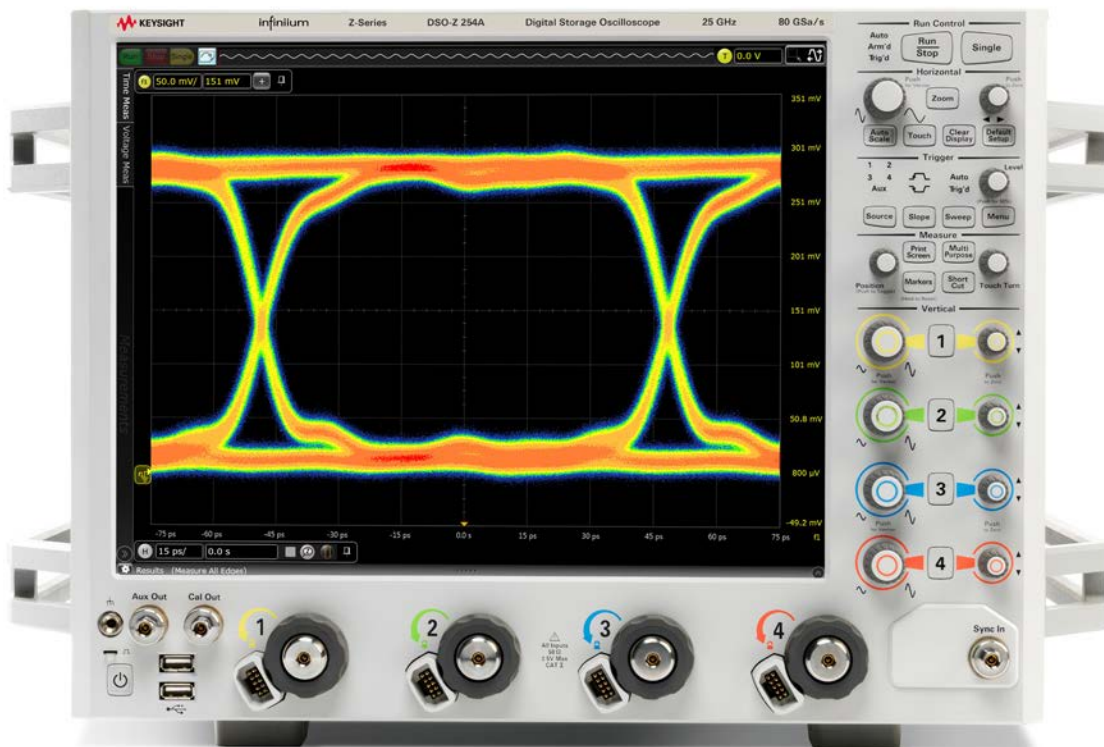

Unlocking Measurement Insights

## Table of Contents

Features .....	4
Benefits .....	5
Easy Test Definition .....	6
PCI Express 3.0 .....	7
Configurability and Guided Connections .....	8
Reports with Margin Analysis .....	9
Extensibility .....	11
Automation .....	12
Switch Matrix .....	13
Receiver Stressed Eye Calibration.....	14
Reference Clock Measurements .....	16
Powerful Debugging Aids .....	17
Measurement Requirements .....	19
Recommended Test Accessories .....	20
Test Performed .....	21
Ordering Information .....	22

## Verify and debug your PCI Express® designs more easily

Keysight Technologies, Inc. PCI Express electrical performance validation and compliance software provides you with a fast and easy way to verify and debug your PCI Express 3.0, 2.0, and 1.1/1.0a designs for both silicon validation (as per the PCIe® BASE specification) as well as for add-in cards and motherboard systems (as per the PCIe CEM specification).

The PCI Express electrical test software allows you to automatically execute PCI Express electrical transmitter tests, and it displays the results in a flexible report format. In addition to the measurement data, the report provides a margin analysis that shows how closely your device passed or failed each test.

The PCI Express electrical test software utilizes the prescribed test methods and algorithms as required by the PCI Express Card Electromechanical (CEM) specifications for all current PCI Express Standards. This produces results that are not only consistent with the PCI-SIG® SigTest utility, but also provides you with a fast and easy means of executing complex two-port motherboard tests and single port add-in card test with total automation.

In addition to transmitter testing, the PCI Express electrical test software also provides an optional receiver test calibration test suite, which allows you to setup your N4903B JBERT bit error ratio tester for performing PCI Express 3.0 jitter tolerance testing under the PCIe 3.0 BASE specification.

The PCI Express electrical performance validation and compliance software performs a wide range of electrical tests as per the PCI Express PCI Express 2.0 and 1.1/1.0a. electrical specifications for add-in cards and motherboard systems as documented in Section 4 of the base specification and Section 4 of the card electromechanical specification.

Tests for PCI Express 3.0 (based on section 4.3.3.10 and 4.3.3.13) are also included to help you test your products against for the next generation of this powerful I/O technology.

In addition to full swing (800 mV) testing, the software also supports testing for low-power, half-swing devices (400 mV) as per the PCI Express Architecture Mobile Graphics Low-Power Addendum to the PCI Express Base Specification Revision 1.0.

## Features

The PCI Express electrical test software offers several features to simplify the validation of PCI Express designs:

- PCIe 3.0 measurements for uncorrelated TJ, DJ, and PWJ, pseudo package loss, and preset de-emphasis and preshoot.
- Automated 1.6 M Unit Interval (or greater) testing for highest accuracy when embedding PCIe reference channel and package model losses
- Results consistent with PCI-SIG SigTest software utility
- Support for de-embedding of test fixtures and cables <sup>1</sup>
- Test setup wizard for ease-of-use
- Wide range of electrical transmitter and reference clock tests
- PCI-SIG SigTest clock recovery algorithm
- Optional integrated receiver test calibration suite for automated calibration (BASE spec) of your N4903B JBERT <sup>2</sup>
- Automated scope measurement setup
- Test results report generation
- Pass/fail margin analysis
- Reference clock phase jitter analysis
- Two-port (explicit clock and data) supported for motherboard signal quality testing
- Support for both full-swing and low-power, half-swing devices.

With the PCI Express electrical test software, you can use the same oscilloscope you use for everyday debugging to perform automated testing and margin analysis based on the PCI-SIG-specified tests.

## PCI Express compliance testing

To pass signal quality testing at a PCI-SIG-sponsored compliance workshop, your product must successfully pass “Gold Suite” testing, based on the PCI-SIG SigTest application. The SigTest application tests your device against the minimum signal-quality performance requirements for PCI. If you are developing receivers and transmitters for add-in boards and system motherboards, the PCI Express electrical test software helps you execute the SigTest tests and additional oscilloscope already completed tests. See the list of tests in Table 3 on page 16 (for 1.1 test coverage).

While SigTest tests provide a good overview of PCI Express electrical signal quality, they address only a small subset of the electrical compliance measurements specified in the PCI-SIG specification. The SigTest application also provides minimal reporting capability with pass/fail indication and measurement values, and has limited debugging capabilities to decipher eye mask violations or excessive jitter.

For PCI Express 3.0 measurements, the software automatically calculates uncorrelated total jitter, uncorrelated deterministic jitter, uncorrelated PWJ necessary for validating new PCIe 3.0 compliant chipsets. For versions of devices compliant with PCI Express 2.0 or earlier, random jitter is also reported for completeness and a voltage margin “eye” diagram is included in the final HTML report. DJ and TJ values are specified in the PCIe 2.0 specification and are required for compliance verification.



Figure 1. PCI Express 2.0 supports data rates up to 5.0 GT/s as shown above (–3.5 dB de-emphasis).

1. Requires the purchase of the optional Keysight Infiniium Waveform Transformation Toolset for Infiniium Oscilloscopes.
2. Requires the purchase of N5393D-4FP software license. Receiver test hardware and fixtures not included and must be purchased separately.

## Benefits

### PCI Express electrical test software benefits

The PCI Express electrical test software saves you time by setting the stage for automatic execution of PCI Express electrical tests, including JBERT jitter stress calibration (optional). Part of the difficulty of performing electrical tests for PCI Express is hooking up the oscilloscope, loading the proper setup files, and then analyzing the measured results by comparing them to limits published in the specification. The PCI Express electrical test software does much of this work for you. In addition, if you discover a problem with your device, robust debug tools are available to aid in root-cause analysis. These debug tools are provided by the Keysight E2688A high-speed serial data analysis software, which you must install on your oscilloscope to use the PCI Express electrical test software.

The software also now has an integrated interface for controlling the InfiniiSim Waveform Transformation Toolset for de-embedding of test fixtures. Introduced with PCIe 2.0, de-embedding of test fixtures utilizes S-parameters as input to create a de-embed model that helps to restore high frequency signal content that is often lost or significantly attenuated by test fixtures and cables. This can help to recover significant jitter margin normally lost to fixtures used in a test setup.

The software can be purchased with an optional test suite for performing the calibration of your Keysight JBERT (B) bit error ratio tester for stressed eye receiver testing for PCIe 3.0 silicon. This helps ensure consistent run-to-run setup of the instrumentation, saving you time and providing consistent and accurate receive test results.

The PCI Express electrical test software offers many more electrical tests than the SigTest application. Unlike the SigTest application, the PCI Express electrical test software automatically configures the oscilloscope for each test, and it provides an informative results report that includes margin analysis indicating how close your product is to passing or failing a particular test assertion. Table 1 shows a side-by-side comparison of the capabilities of the SigTest application and the Keysight PCI Express electrical test software. A list of the measurements made by the PCI Express electrical test software can be found in Table 3, (Table 3 contains comparison of SigTest vs. Keysight).

**Table 1. Comparison of capabilities of the Keysight PCI Express electrical test software and the PCI-SIG SigTest application**

Capability	Keysight PCI Express software	PCI-SIG SigTest
Support for PCIe 3.0	BASE Spec	N/A
Integrated de-embedding support	Yes (InfiniiSim waveform transformation toolset required)	No
Number of measurement assertions	16+	4
Support for PCIe 1.0a, 1.1, 2.0	Yes	Yes
Reference clock tests	10 (1.1)	0 <sup>1</sup>
Automated oscilloscope setup for each measurement	Yes, guided	No, single setup
Measurement results	Pass/fail with margin analysis	Pass/fail with measured value
CEM based measurement methodology	Yes	Yes
Clock recovery method	PCI-SIG SigTest or 1st/2nd order PLL	PCI-SIG SigTest
Brick wall filter (2.0 testing)	Yes	Yes
Custom HTML report generation	Yes	No
Support for low power device	Yes	No
Selectable number of tests performed	Yes	No
Multi-trial run support	Yes	No
Debug mode for "what if" analysis	Yes	No
Compliance test boards supported	CBB1, CBB2, CLB1, CLB2	CBB1, CBB2, CLB1, CLB2

1. PCI-Sig offers a separate utility (Clock\_Jitter) for analyzing reference clock phase jitter.

## Easy Test Definition

The PCI Express electrical test software extends the ease-of-use advantages of Keysight's Infiniium oscilloscopes to testing PCI Express designs. The Keysight automated test engine walks you quickly through the steps required to define the tests, set up the tests, perform the tests, and view the test results. You can select a category of tests all at once, or specify individual tests. You can save tests and configurations as project files and recall them later for quick testing and review of previous test results. Straightforward menus let you perform tests with a minimum of mouse clicks.

The software allows you to easily specify the test standard you want to use to test the compliance of your device. This makes test setup easy as only the appropriate tests for the test point you pick are shown on later test selection pages.

Pick the standard you want to test against

Choose the test point or specific signal you want to test

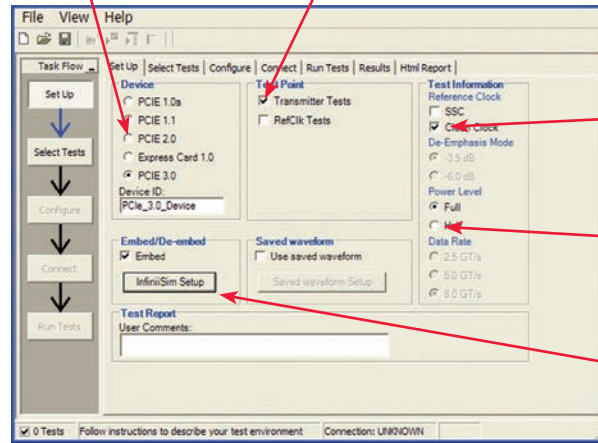

Test with SSC enabled or with a clean clock (for compliance)

Choose half swing if testing low power devices

De-embed test fixtures with the optional InfiniSim waveform transformation toolset

Figure 2. The software allows you to easily specify the test standard you want to use to test the compliance of your device. This makes test setup easy as only the appropriate tests for the test point you pick are shown on later test selection pages.

Easy to follow task flow for configuring and running tests

Select one test or a group of tests with a single mouse click

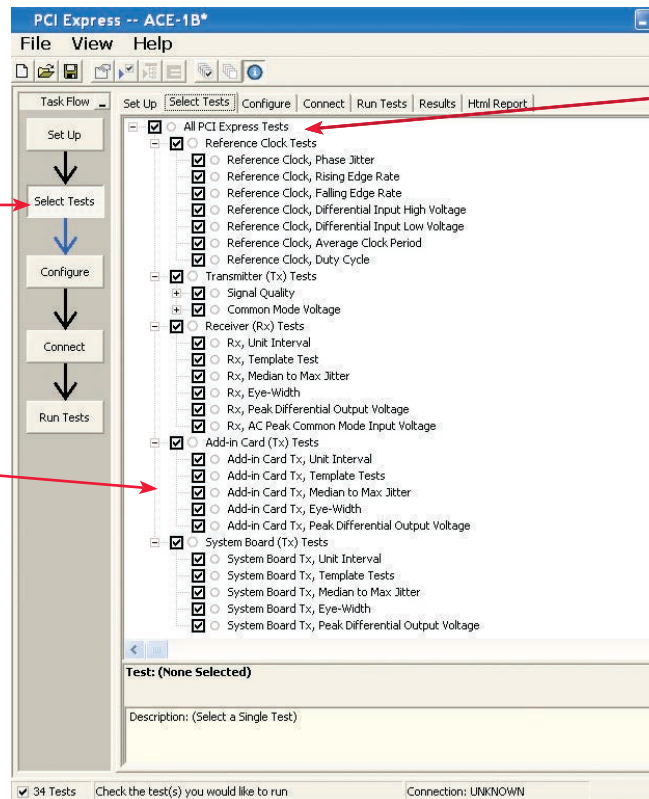

Test your reference clock for phase jitter to help ensure clean high data rate transmissions

Figure 3. The Keysight automated test engine guides you quickly through selecting tests, configuring tests, setting up the connection, running the tests, and viewing the results. Individual tests or groups of tests are easily selected with a mouse click.

## PCI Express 3.0

The N5393D includes support for testing PCI Express 3.0 devices. The tests supported include new jitter, voltage, de-emphasis, preshoot, pseudo S21 loss and others defined by the PCI Express 3.0 BASE specification. In addition, with the addition of the optional InfiniiSim Waveform Transformation Toolset, the N5393D also integrates de-embedding of test channel and cable losses with user-supplied S-parameters for fixtures and connectors. De-embedding is used to recover jitter losses due to the attenuation of high frequency elements caused by the test channel.

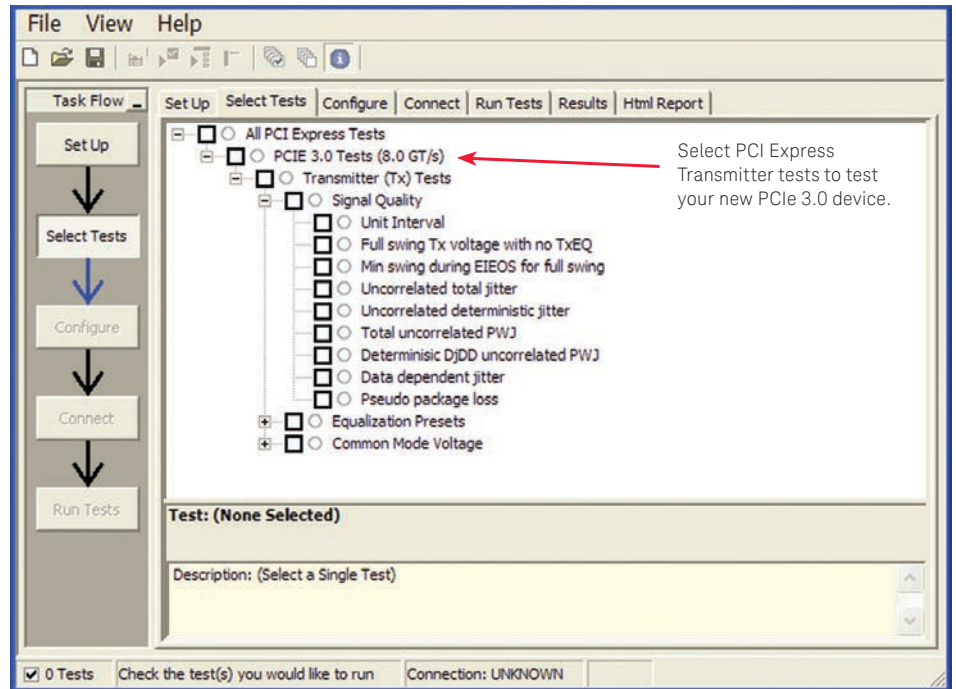

Figure 4. PCI Express 3.0 transmitter tests.

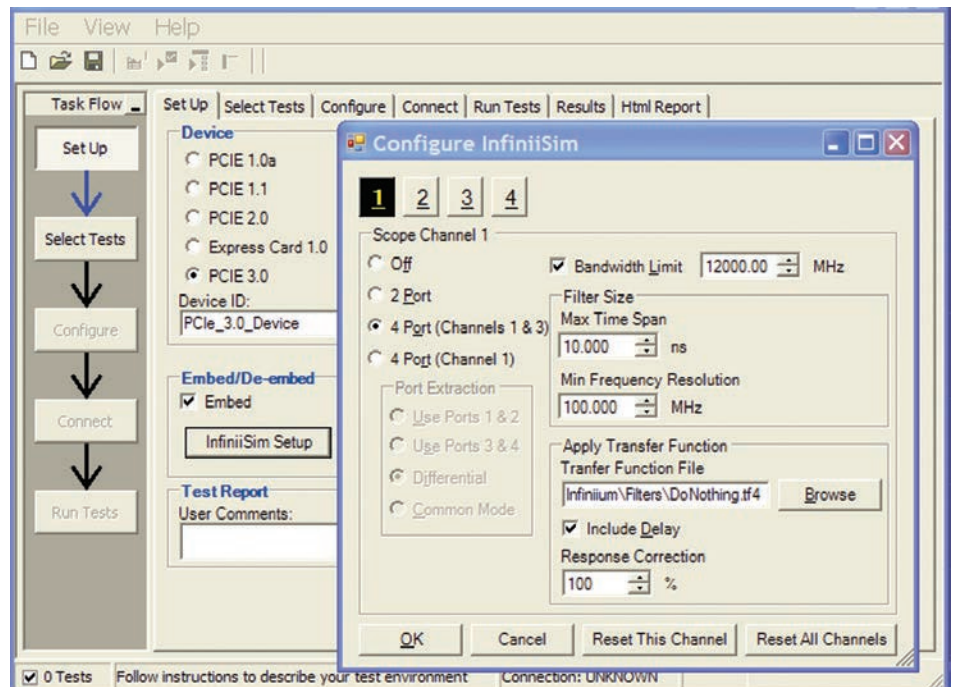
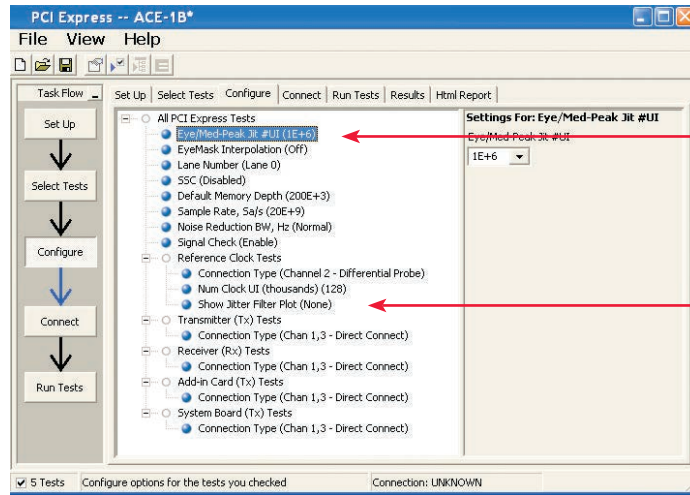

Figure 5. The N5393D integrates de-embedding capability when coupled with the optional InfiniiSim waveform transformation toolset.

## Configurability and Guided Connections

The PCI Express electrical test software provides flexibility in your test setup. It guides you to make connection changes with hookup diagrams when the tests you select require it. All PCI Express electrical compliance tests you perform are based on the official PCI-SIG approved set of test fixtures. The compliance fixtures include the Compliance Base Board (CBB2) for add-in card testing, and the Compliance Load Board (CLB2) for motherboard or system testing. Connection to the compliance test fixtures is selectable between SMA/SMP cables or Keysight InfiniiMax active differential probes.



Specify 1 million UI (or more) for your jitter measurements

Show the spectral response of your reference clock in the critical 1.5 to 22-MHz region

Figure 6. In configuring the tests, you specify the device to test, its configuration, and how the oscilloscope is connected.

If more than one test setup connection is required, you will be notified here

You are prompted to make the appropriate connections for the set of tests

Toggle circuit to switch between Gen1 (2.5 GBit/s) and Gen2 (50 GBit/s)

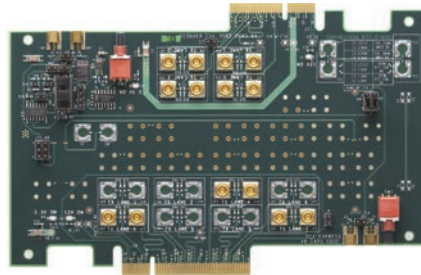
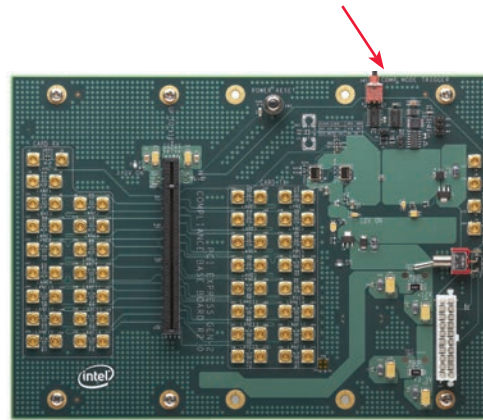
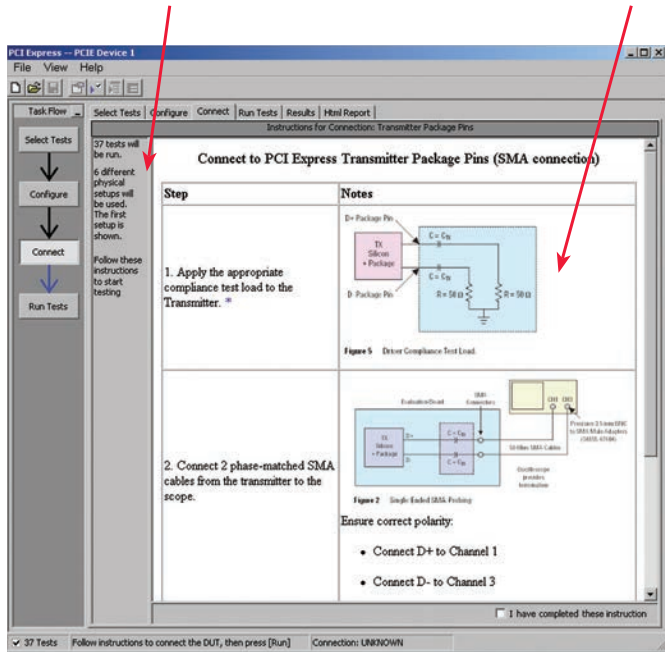

Figure 7. When you make multiple tests where the connections must be changed, you are prompted with connection diagrams and/or photographs.

Figure 8. The PCI-SIG Compliance Base Board (CBB2) for Gen2 add-in card testing, and the Compliance Load Board (CLB2) for Gen2 motherboard or host system testing.



## Reports with Margin Analysis

In addition to providing you with measurement results, the PCI Express electrical test software provides a report format that shows you not only where your product passes or fails, but also reports how close you are to the limits specified for a particular test assertion. You can select the margin test report parameter, which means you can specify the level at which warnings are issued to alert you to electrical tests where your product is operating close to the official test limit defined by the PCI Express 2.0, 1.0a or 1.1 specifications.

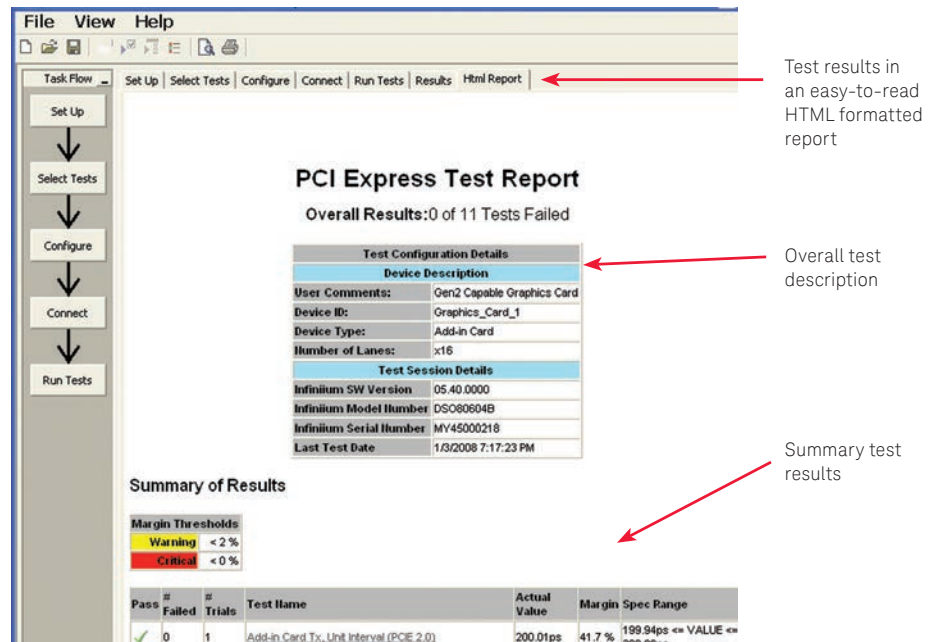

Figure 9. The PCI Express electrical test software results report documents your test, indicates the pass/fail status, the test specification range, the measured values, and shows how much margin you have.

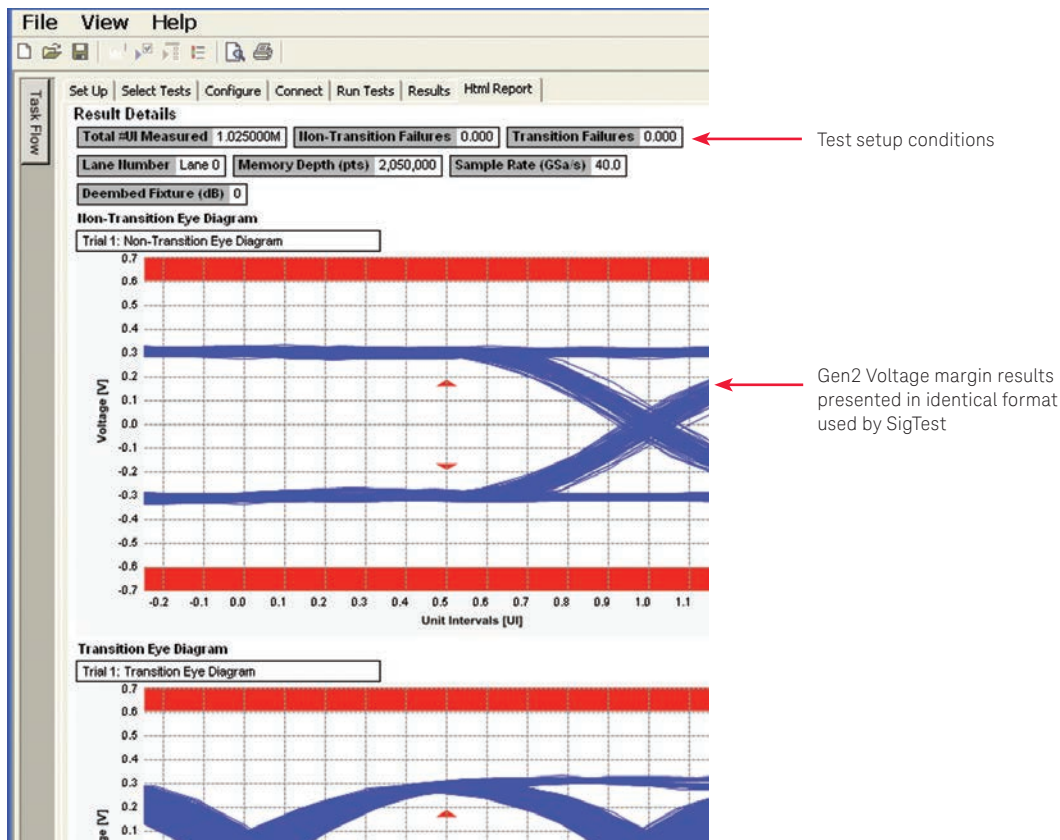

Figure 10. The HTML report provides additional details including test setup conditions, graphical results, and test limits (where appropriate).

## Reports with Margin Analysis (Continued)

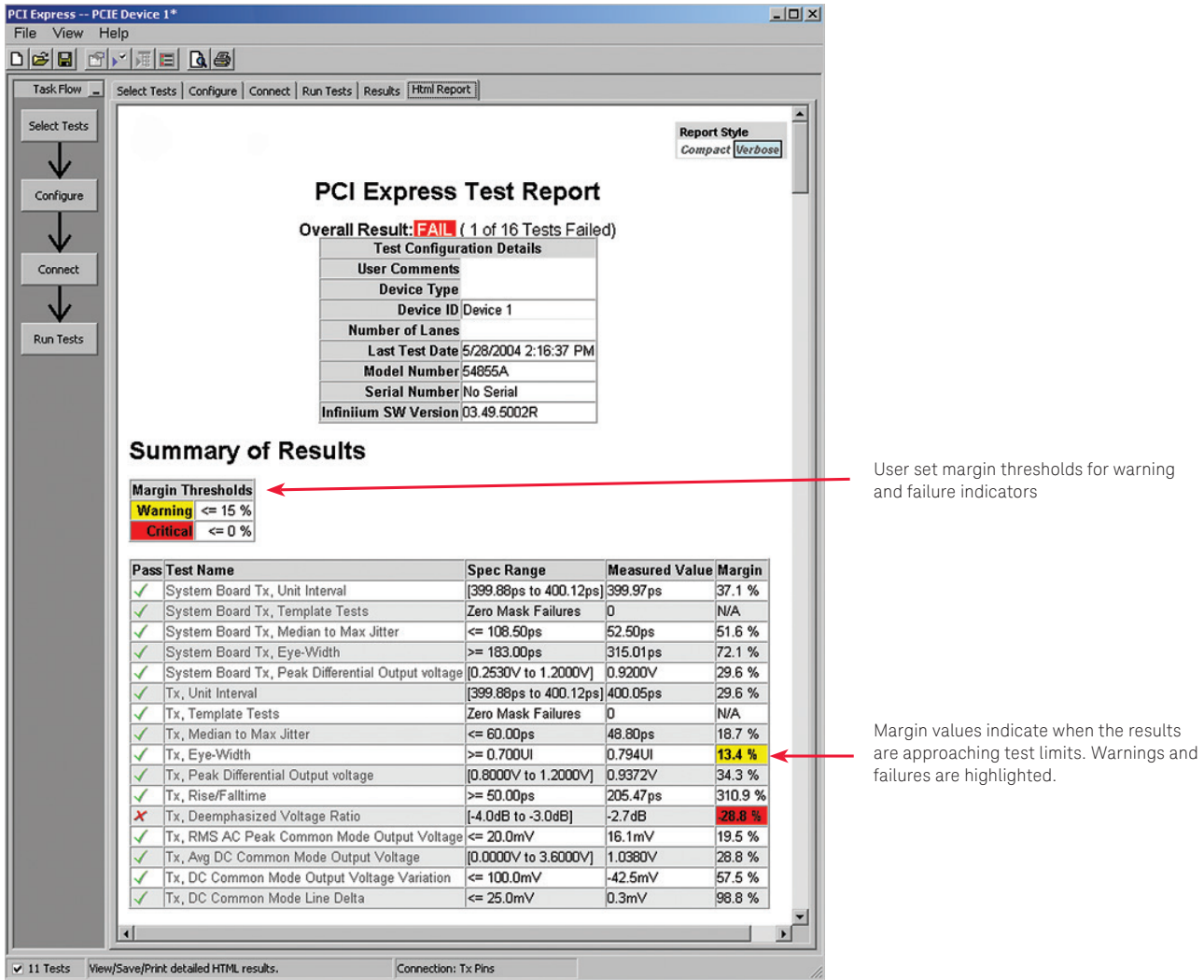

Figure 11. How close you are to passing or failing a test is indicated as a % in the margin field. A result highlighted in yellow or red indicates that the margin threshold level for a warning or failure was detected.

## Extensibility

You may add additional custom tests or steps to your application using the User Defined Application (UDA) development tool ([www.keysight.com/find/uda](http://www.keysight.com/find/uda)). Use UDA to develop functional “Add-Ins” that you can plug into your application.

Add-ins may be designed as:

- Complete custom tests (with configuration variables and connection prompts)
- Any custom steps such as pre or post processing scripts, external instrument control and your own device control

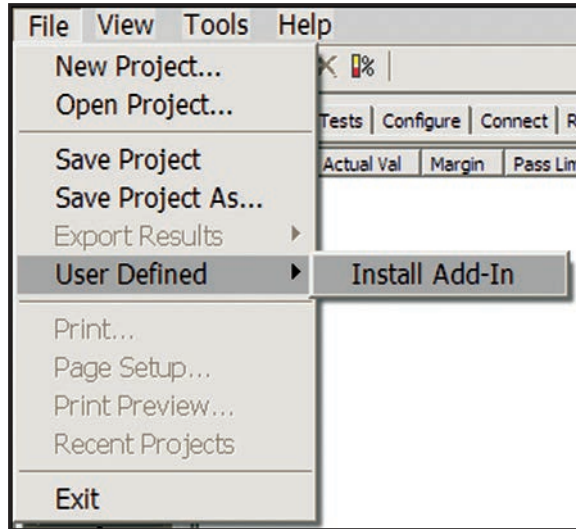

Figure 12. Importing a UDA Add-In into your test application.

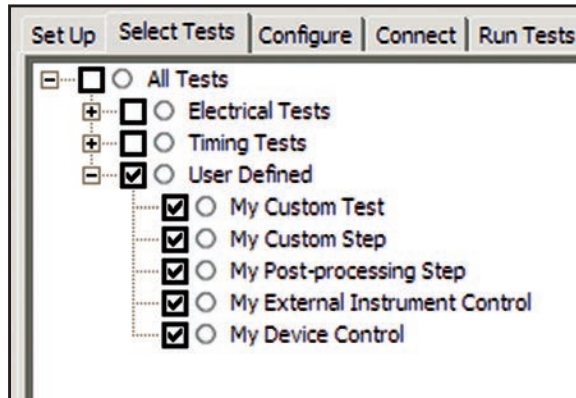

Figure 13. UDA Add-In tests and utilities in your test application.

## Automation

You can completely automate execution of your application's tests and Add-Ins from a separate PC using the included N5452A Remote Interface feature (download free toolkit from [www.keysight.com/find/scope-apps-sw](http://www.keysight.com/find/scope-apps-sw)). You can even create and execute automation scripts right inside the application using a convenient built-in client.

The commands required for each task may be created using a command wizard or from "remote hints" accessible throughout the user interface.

Using automation, you can accelerate complex testing scenarios and even automate manual tasks such as:

- Opening projects, executing tests and saving results
- Executing tests repeatedly while changing configurations
- Sending commands to external instruments
- Executing tests out of ord

Combine the power of built-in automation and extensibility to transform your application into a complete test suite executive:

- Interact with your device controller to place it into desired states or test modes before test execution.
- Configure additional instruments used in your test suite such as a pattern generator and probe switch matrix.
- Export data generated by your tests and post-process it using your favorite environment, such as MATLAB, Python, LabVIEW, C, C++, Visual Basic etc.
- Sequence or repeat the tests and "Add-In" custom steps execution in any order for complete test coverage of the test plan.

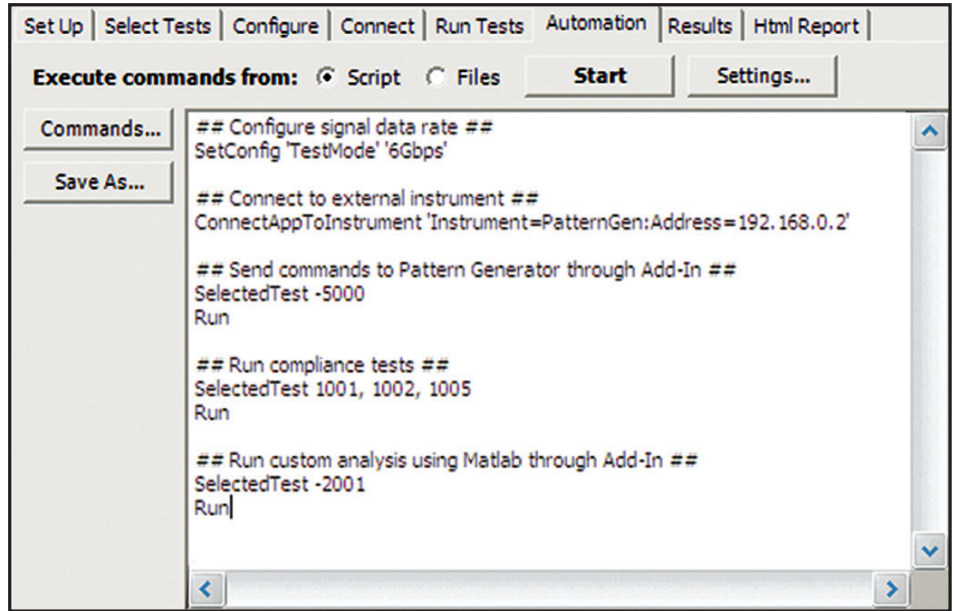

Figure 14. Remote Programming script in the Automation tab.

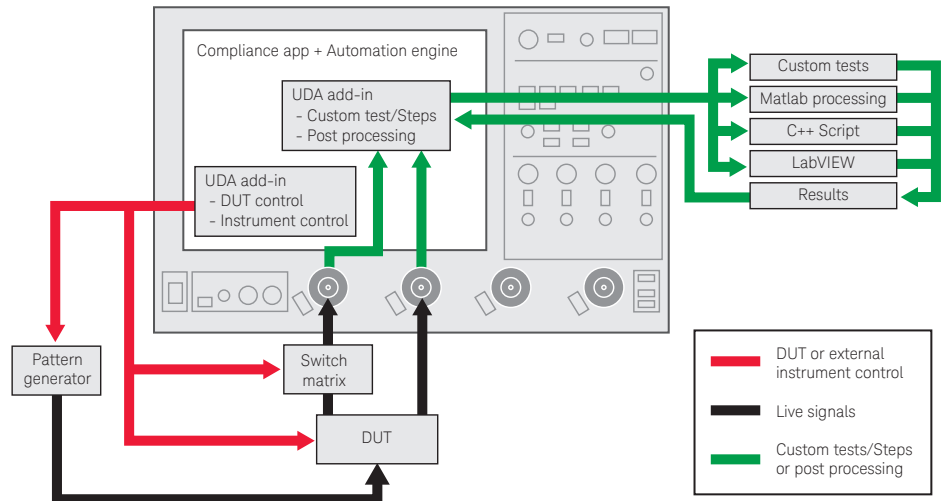

Figure 15. Combine the power of built-in automation and extensibility to transform your application into a complete test suite executive.

## Switch Matrix

The Keysight N5393D Option 7FP switch matrix software tool for the PCI Express compliance application, used together with switch matrix hardware, enables fully automated testing for this multi-lane digital bus interface. The benefits of this automated switching solution include:

- Eliminate reconnections, which saves time and reduces errors through automating test setup for each lane of a multi-lane bus.
- Maintain accuracy with the use of unique N2809A PrecisionProbe or InfiniiSim features to compensate for switch path losses and skew.
- Customize testing by using remote programming interface and the user-defined application tool for device control, instrument control and test customization.



Figure 16. Automated testing for multi-lane digital bus interface through switching solution.

More information of the switching solution and configuration, visit <http://literature.cdn.keysight.com/find/switching> and the Keysight application note with the publication number 5991-2375EN.

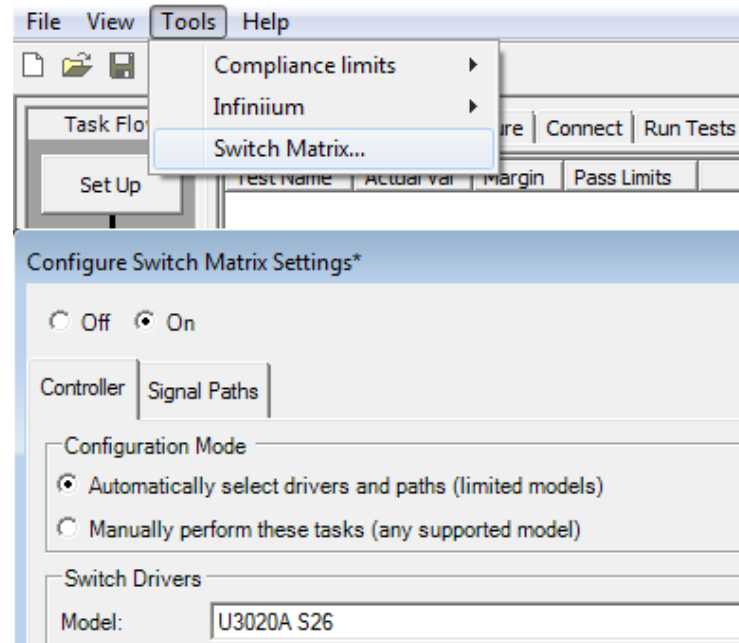

Figure 17. Switch matrix software feature enabled in the compliance application.

## Receiver Stressed Eye Calibration

The PCI Express 3.0 BASE specification outlines the requirements for a PCIe 3.0 compliant receiver equalizer. The capabilities defined employ a reference equalizer that consists of a CTLE (continuous time linear equalizer) and a single tap DFE (decision feedback equalizer).

In order to ensure that your devices receiver equalizer is at least as capable as the reference equalizer defined in the PCIe 3.0 BASE specification, it is necessary to execute a stressed eye receiver test. The signal that must be presented to the receiver must represent a worst case condition yet still be a valid and compliant PCIe 3.0 signal.

To achieve this calibrated worst case signal, it is necessary to carefully construct a significantly small amplitude signal that contains a prescribed amount of certain specified impairments. These impairments include sinusoidal jitter, random jitter, and channel induced intersymbol interference (ISI). In addition, it is necessary to add common mode and differential mode noise simultaneously to the jitter cocktail in order to emulate system crosstalk.

The N5393D-4FP along with your N4903B JBERT bit error ratio tester and required accessories, such as an 81150A Pulse Function Arbitrary Noise Generator, N4916B De-emphasis Signal Converter, and N4915A-014 PCI Express 3.0 calibration channels.

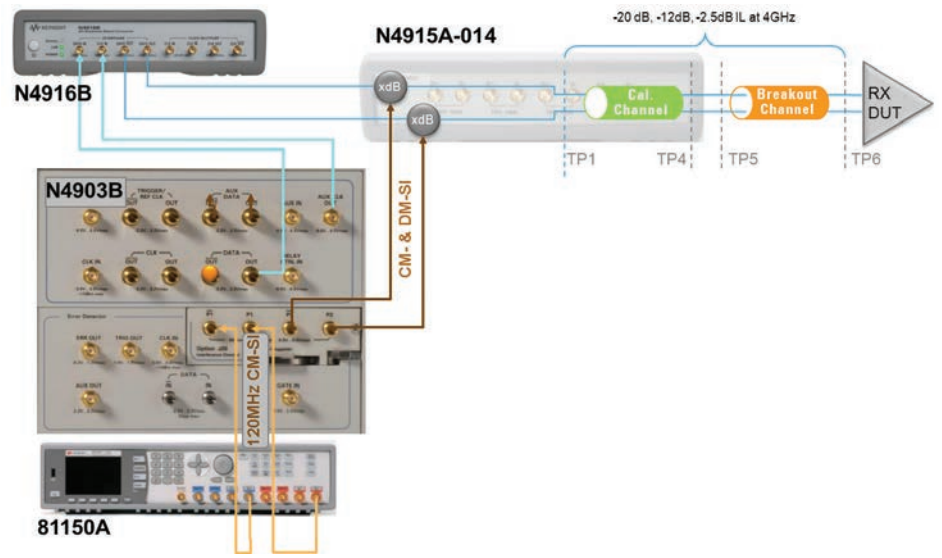

Figure 18. N4903B JBERT Setup for PCIe 3.0 Receiver Stress Testing.

Set target stressed voltage test parameters for the calibration

Set target stressed jitter test parameters for the calibration

Figure 19. Setting up instrument control of the N4903B and 81150A from the PCIe application.

## Receiver Stressed Eye Calibration (Continued)

The N5393D utilizes the PCI SIG's own Seasim simulation software to determine the target signal impairments and communicates those parameters to the instruments configured as part of the receiver test setup. The Keysight DSA90000 series oscilloscope is used to capture traces from the JBERT system setup, and that information is used by Seasim to set the calibration values of the bit error ratio tester setup.

The N5393D utilizes the PCI SIG's own Seasim simulation software to determine the target signal impairments and communicates those parameters to the instruments configured as part of the receiver test setup. The Keysight DSA90000 series oscilloscope is used to capture traces from the JBERT system setup, and that information is used by Seasim to set the calibration values of the bit error ratio tester setup.

The N5393D option 004 is provided to help automate the most rigorous step in receive testing, the calibration step. Once the equipment is calibrated, the actual receiver stress test can be performed manually or by using additional automation tools provided by Keysight and its partners. The N5393C-4FP covers automates only the calibration step. You can also reference the Keysight application note on PCIe 3.0 BASE spec receiver testing at: <http://literature.cdn.keysight.com/litweb/5990-6599EN.pdf> for additional information.

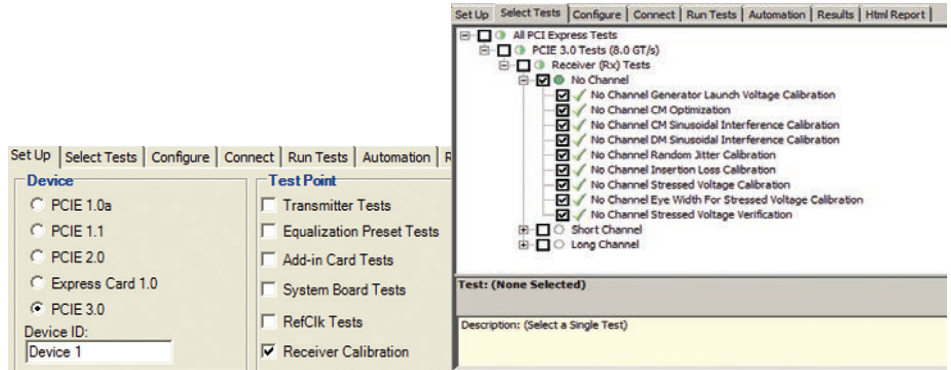

Figure 20. Configuring the type of receiver test calibration to perform.

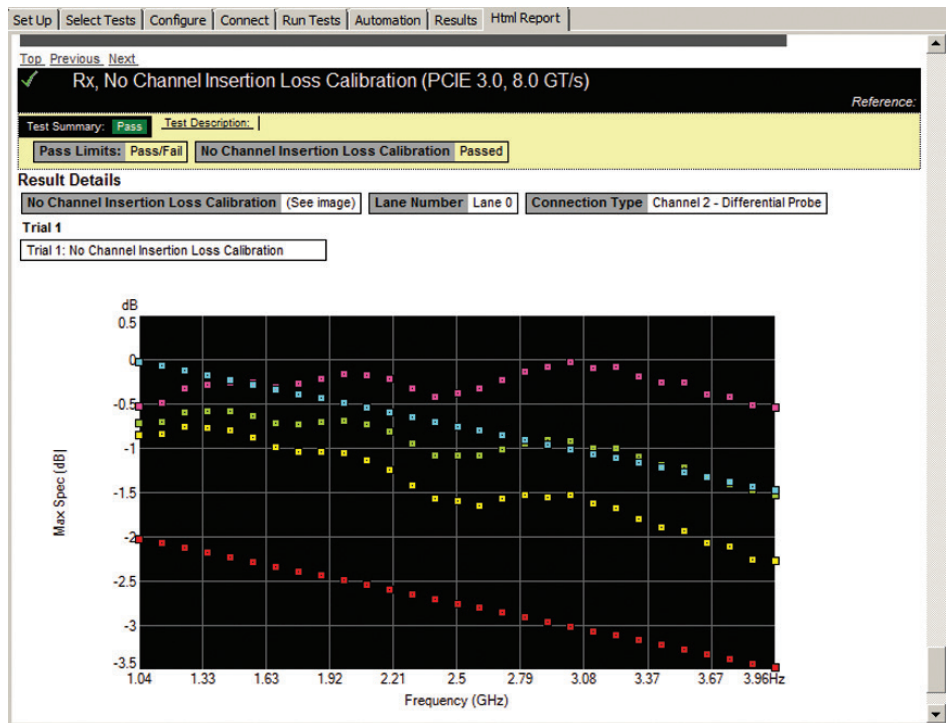

Figure 21. In the HTML test report the N5393D generates the appropriate graphical summary for each calibration parameter it configures. This gives you a traceable reference for how the tool setup and the calibration can save time when de-bugging the RX test setup.

## Reference Clock Measurements

The PCI Express 1.0a specification failed to specify the input bandwidth the reference clock receiver or phase jitter of the reference clock itself. This is important because jitter that lies within the loop bandwidth the receiver PLL for the reference clock will transfer onto the high speed data lines. This hole in the PCI Express specification was corrected in the 1.1 update.

The N5393D includes powerful reference clock evaluation tools including phase jitter. The PCIe 1.1 specification calls for a very specific phase jitter filter that focuses the measurement on the jitter that lies between 1.5 and 22-MHz. The filter also amplifies the jitter 3 dB (peaking) within this region. The Keysight N5393D includes proprietary filtering software (patent pending) that exactly implements the filters specified in the PCI Express specification. The N5393D also includes reference clock tests based on the PCIe 2.0 and 3.0 specification.

Utilizing Keysight's InfiniiMax 1169A high performance differential probes, or direct cabled connections, you can measure your reference clock using the PCI-SIG's Compliance Load Board or custom test fixture.

- Reference clock tests
- Phase jitter
- Rising edge rate
- Falling edge rate
- Differential input high voltage
- Differential input low voltage
- Average clock period
- Duty cycle

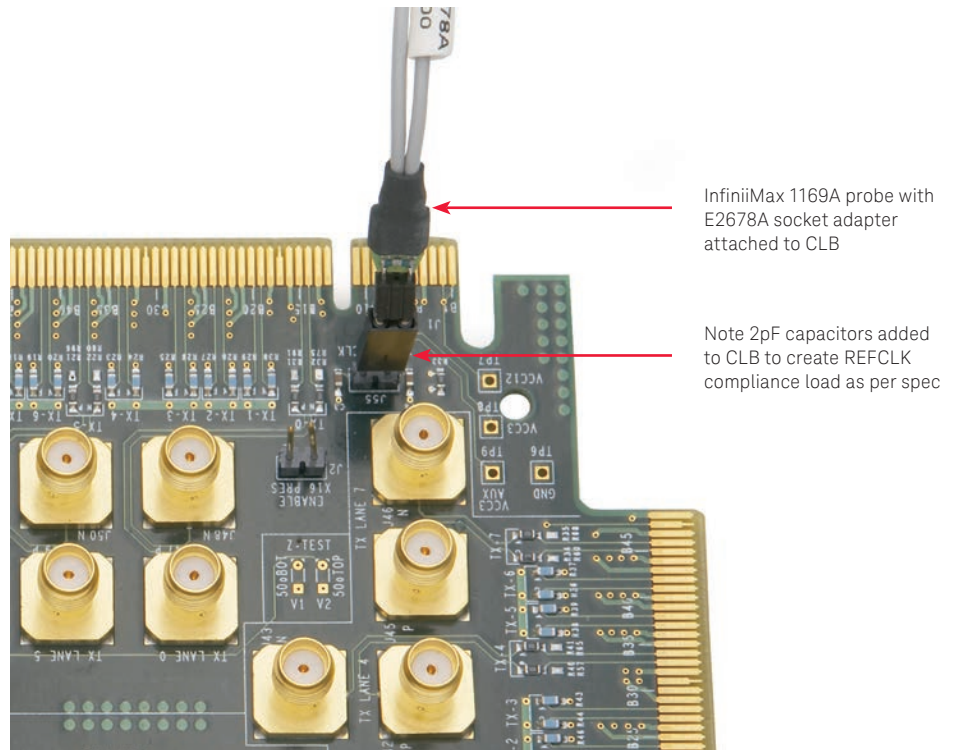

Figure 22. The N5393D software includes important tests for the reference clock of your PCI Express system. This signal can be probed using the Keysight InfiniiMax 1169A probes in conjunction with the PCI-SIG's compliance load board.

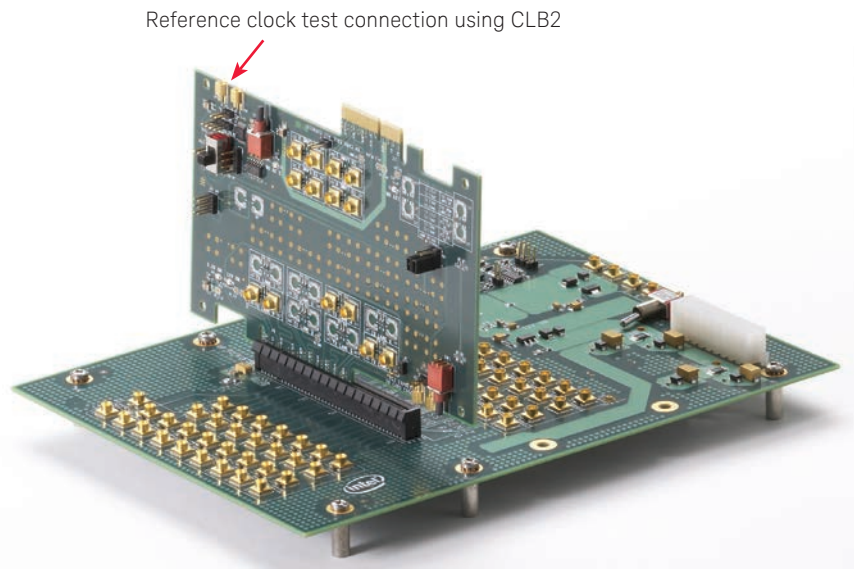

Figure 23. This shows the CLB2 inserted into the CBB2 test fixture, representing the setup required to test add-in cards.



## Powerful Debugging Aids

If your device fails a test, you need to determine how it failed. To use the PCI Express electrical test software, you must install Keysight's high-speed serial data analysis software, which provides you with several powerful debugging tools. The 8b/10b decoding feature lets you identify data-dependent errors that result in eye mask violations caused by inter-symbol interference (ISI). You can perform 8b/10b decoding to capture and display serial data synchronized with the analog view of a serial data stream (For PCIe 1.x and 2.x).



Make sure your compliance pattern has the proper disparity (K28.5-, D21.5, K28.5+, D10.2)

Use the 10-bit code display to validate your compliance pattern conforms to the PCI Express standard

Figure 24. The 8b/10b decoded symbol information is shown below the appropriate portion of a PCI Express signal using the E2688A software.

Using the E2688A Serial Data Analysis tool you can test for illegal characters in your compliance pattern. You can also use the mask test feature to identify the specific digital patterns that caused a specific failure in the eye diagram when testing under the 1.1 specification (using a first order PLL).

For 2.0 testing you can use a first or second order PLL for clock recovery and apply a TIE brick wall filter (included with the E2688A Series Data Analysis package) to achieve a proper clock filtering.



Problems with early silicon still persist with new PCI Express devices. Make sure yours isn't one of them. SKP characters are not allowed in the compliance pattern.

Figure 25. Check for illegal characters in the compliance pattern (such as SKP's) using the E2688A Serial Data Analysis tool.

## Powerful Debugging Aids (Continued)

**Real Time Eye**

Individual bit errors may be observed by unfolding a real time eye. To position to the first failure, stop the acquisition when failures have occurred. You may use Stop On Failure in the mask test

Number of failed UI: 1

Position To First Failure

Close

Help

Use the Navigation Tab to search for mask failures.

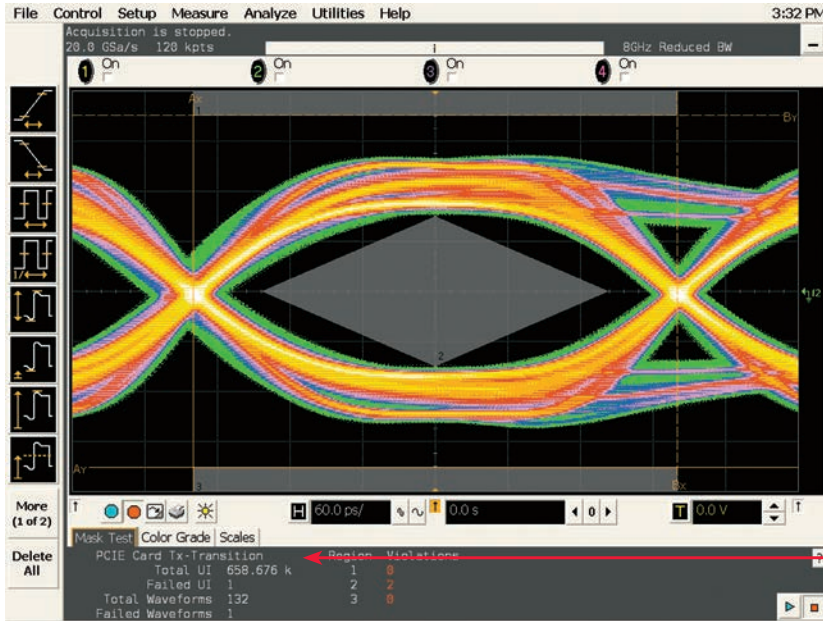

This eye fails after 658K UIs are analyzed

Figure 26.

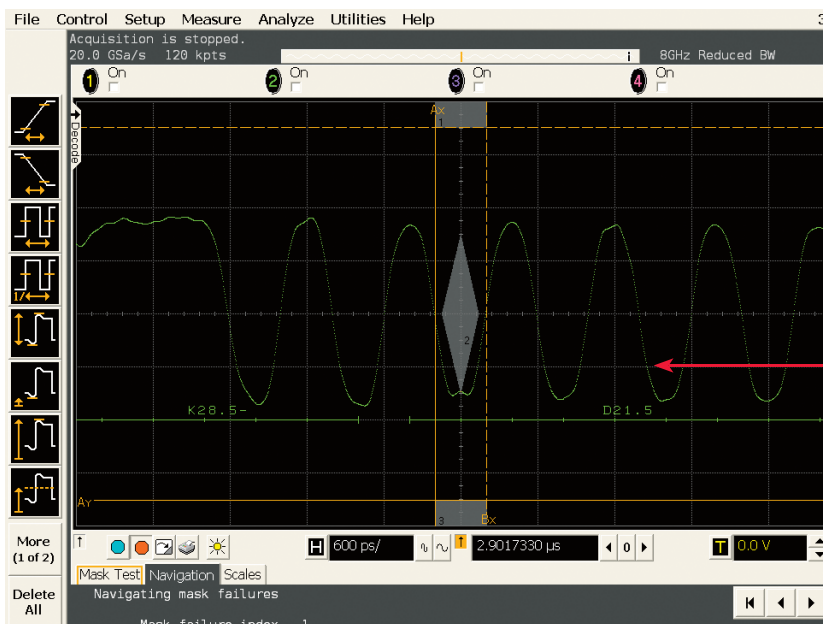

Here you see the specific waveform (and 10-bit code) that caused the eye failure

Figure 27. The E2688A allows you to show the specific waveform that caused an eye diagram failure.

## Measurement Requirements

The PCI Express electrical performance validation and compliance software requires the E2688A high-speed serial data analysis software, one of the PCI-SIG approved compliance test fixtures (CBB or CLB), and at least two SMA cables or InfiniiMax active differential probes. The N5393D optionally requires the InfiniiSim waveform transformation toolset to enable to de-embedding or de-convolving of test fixture and cable losses based on user supplied S-parameter descriptions of these structures. Some of the measurements cannot be made with the PCI-SIG compliance test fixtures and may require you to build or acquire a custom test board, assembly, or other test fixture.

To purchase the PCI Express compliance test fixtures, consult the PCI-SIG Web site and select the PCI-SIG specification order form link at: [www.pcisig.com/specifications/ordering\\_information](http://www.pcisig.com/specifications/ordering_information)

Compliance test fixture	Description
CBB	PCI Express Compliance Base Board for testing PCI Express add-in cards
CLB	PCI Express Compliance Load Board for testing PCI Express platforms
CBB2	Gen 2 PCI Express Compliance Base Board for testing PCI Express add-in cards
CLB2	Gen2 PCI Express Compliance Load Board for testing PCI Express platforms
CBB3	Gen 3 PCI Express Compliance Base Board for testing PCI Express add-in cards
CLB3	Gen3 PCI Express Compliance Load Board for testing PCI Express platforms

## Bandwidth requirements for PCI Express

PCI Express operates at 2.5 GT/s, 5 GT/s and 8 GT/s. Below are two tables that provide guidelines on the minimum bandwidth and sample rate required for PCI Express Transmitter measurements. In addition to transmitter measurements, phase jitter measurements of the PCIe 100 MHz reference clock also call for a minimum sample rate used to measure the clock as is also shown below. Use this information to help you select the proper oscilloscope for your specific requirements.

PCI Express bandwidth requirements by data rate for transmitter measurements		
Data rate	Minimum bandwidth required	Minimum sample rate
2.5 GT/s	6 GHz	20 GSa/s
5 GT/s	12 GHz	40 GS/s
8 GT/s	12 GHz	40 GS/s

PCI Express sample rate requirements for reference clock measurements	
PCIe standard	Minimum sample rate
1.1	20 GSa/s
2.x	20 GSa/s
3.x	20 GSa/s

## Recommended Test Accessories

To complete your test setup, Keysight provides a wide range of cables, adapters, terminations, etc.

*Note: While the PCI-SIG does supply Gen2 test fixtures for motherboard and add-in card testing, you will need to obtain SMP cables, adapters and terminators from a vendor of your choice as the SIG does not supply them.*

**Table 2. Recommended test accessories**

Model number	Description
<b>Add-in card testing</b>	
	PCI-SIG Compliance Base Board (order from <a href="http://www.pcisig.com/specifications/ordering_information">www.pcisig.com/specifications/ordering_information</a> )
15442A	Two SMA cables
	One PC power supply
	One power supply load for regulation
1810-0118	Six 50 $\Omega$ terminators
<b>System motherboard testing</b>	
	PCI-SIG Compliance Base Board (order from <a href="http://www.pcisig.com/specifications/ordering_information">www.pcisig.com/specifications/ordering_information</a> )
15442A	Two SMA cables
1134A or 1169A	InfiniiMax probe with socketed (E2678A) probe adapter
1250-1741	Two right angle SMA adapters (f - m)
1810-0118	Six 50 $\Omega$ terminators
<b>Semiconductor device testing</b>	
	Customer supplied custom test fixtures with SMAs
15442A	Two SMA cables
1169A	One InfiniiMax probe with differential solder connection (E2677A)
<b>Optional (for all types of testing)</b>	
11667B	Power splitter, DC to 26.5 GHz, 3.5 mm (f) connectors
11636B	Power divider, DC to 26.5 GHz, 3.5 mm (f) connectors
1250-1159	Three SMA (m - m) adapters
8493B	Coaxial attenuator (3, 6, 10, 20 or 30 dB), DC to 18 GHz, SMA connector
	Matched cable pair, two 90 cm (36 inch) SMA (m - m) cables propagation delay within 25 ps
1810-0118	SMA (m) 50 $\Omega$ termination

## Tests Performed

The PCI Express electrical performance validation and compliance software performs the following tests as per the PCI Express 1.0a and 1.1 electrical specifications for add-in cards and motherboard systems as documented in Section 4 of the base specification (“PHY”) and Section 4 of the card electromechanical specification (“EM”). For reference, the tests performed by the SigTest application are also noted.

For Gen2 testing coverage, the PCI-SIG decided not to create checklist, as was done for Gen1. For test coverage refer to section 4.7.2. Table 4-8 of the PCI Express 2.0 Card Electromechanical Specification.

For PCI Express 3.0, test coverage includes items listed on table 4-18 under section 4.3.3 of the PCI Express 3.0 Base Specification.

Assertion no.	Description	Keysight PCI Express	SigTest
<b>Transmitter tests</b>			
PHY.3.1#26	DC common mode voltage	Y	N
PHY.3.2#1	De-emphasis on multiple bits same polarity in succession	Y	N
PHY.3.2#2	Transition bit voltage	Y	N
PHY.3.3#1	Transmitter eye diagram	Y	N
PHY.3.3#2	Unit interval without SSC variations	Y	N
PHY.3.3#3	Minimum D+/D- output rise/fall time	Y	N
PHY.3.3#4	Jitter median to max deviation	Y	N
PHY.3.3#5	Maximum RMS AC common mode voltage	Y	N
PHY.3.3#9	Minimum eye width	Y	N
<b>Receiver tests</b>			
PHY.3.4#1	Minimum receiver eye diagram	Y <sup>1</sup>	N
PHY.3.4#2	AC peak common mode input voltage	Y <sup>1</sup>	N
PHY.3.4#6	Jitter median to max deviation input	Y <sup>1</sup>	N
<b>System board (connector) tests</b>			
EM.4#4	Minimum jitter	Y	Y
EM.4#20	Transmitter path eye diagram	Y	Y
<b>Reference clock (connector) tests</b>			
PHY.3.3#2	Phase jitter	Y	N/A <sup>1</sup>
PHY.3.3#1	Rising edge rate	Y	N/A
PHY.3.3#1	Falling edge rate	Y	N/A
PHY.3.3#4	Differential input high voltage	Y	N/A
PHY.3.3#4	Differential input low voltage	Y	N/A
PHY.3.3#9	Average clock period	Y	N/A
PHY.3.2#2	Duty cycle	Y	N/A
<b>Add-in card (connector) tests</b>			
EM.4#13	Minimum jitter	Y	Y
EM.4#19	Transmitter path eye diagram	Y	Y

- Receiver tests provided by the Keysight PCI Express software are listed under the PCIe 1.x or 2.0 test tabs do not validate the receiver’s tolerance or ability to correctly receive data. They validate the signal at the receiver against specified tolerances.

## Ordering Information

### PCI Express 1.x and 2.x transmitter testing

License type		Infiniium Z-Series	Infiniium S-Series	Infiniium 90000 Series
Fixed	Factory-installed	N5393D-3FP	N5393E-3FP <sup>1</sup>	Option 022
	User-installed	N5393D-3FP	N5393E-3FP <sup>1</sup>	N5393D-3NL
Floating	Transportable	N5393D-3TP	N5393E-3TP <sup>1</sup>	N5393D-3TP
	Server-based		N5435A-009	

### Upgrade to PCIe 3.0 transmitter testing

License type		Infiniium Z-Series	Infiniium S-Series	Infiniium 90000 Series
Fixed	Factory-installed	–	–	–
	User-installed	N5393D-2FP	–	N5393D-2NL
Floating	Transportable	–	–	–
	Server-based		–	

### PCIe 3.x transmitter testing

License type		Infiniium Z-Series	Infiniium S-Series	Infiniium 90000 Series
Fixed	Factory-installed	N5393D-1FP	–	Option 044
	User-installed	N5393D-1FP	–	N5393D-1NL
Floating	Transportable	N5393D-1TP	–	N5393D-1TP
	Server-based		N5435A-040	

### PCIe 3.0 BASE spec receiver test calibration

License type		Infiniium Z-Series	Infiniium S-Series	Infiniium 90000 Series
Fixed	Factory-installed	N5393D-4FP	–	–
	User-installed	N5393D-4FP	–	N5393D-4NL
Floating	Transportable	N5393D-4TP	–	N5393D-4TP
	Server-based		–	

### PCIe switch matrix support

License type		Infiniium Z-Series	Infiniium S-Series	Infiniium 90000 Series
Fixed	Factory-installed	N5393D-7FP	N5393E-7FP <sup>1</sup>	Option 705
	User-installed	N5393D-7FP	N5393E-7FP <sup>1</sup>	N5393D-7NL
Floating	Transportable	N5393D-7TP	N5393E-7TP <sup>1</sup>	N5393D-7TP
	Server-based		N5435A-705	

- The S-Series oscilloscope is limited to a maximum bandwidth of 8 GHz which is sufficient bandwidth only for 2.5 GT/s (PCIe 1.x) transmitter measurements. Transmitter measurements for 5GT/s (PCIe 2.x) and 8 GTs (PCIe 3.x) require a minimum scope bandwidth of 12 GHz; however, PCIe 2.x clock phase jitter measurements can be made with the S-Series oscilloscope and are thus enabled with this license. 5GT/s transmitter measurements are not enabled on the S-Series oscilloscope as a higher minimum bandwidth is required.

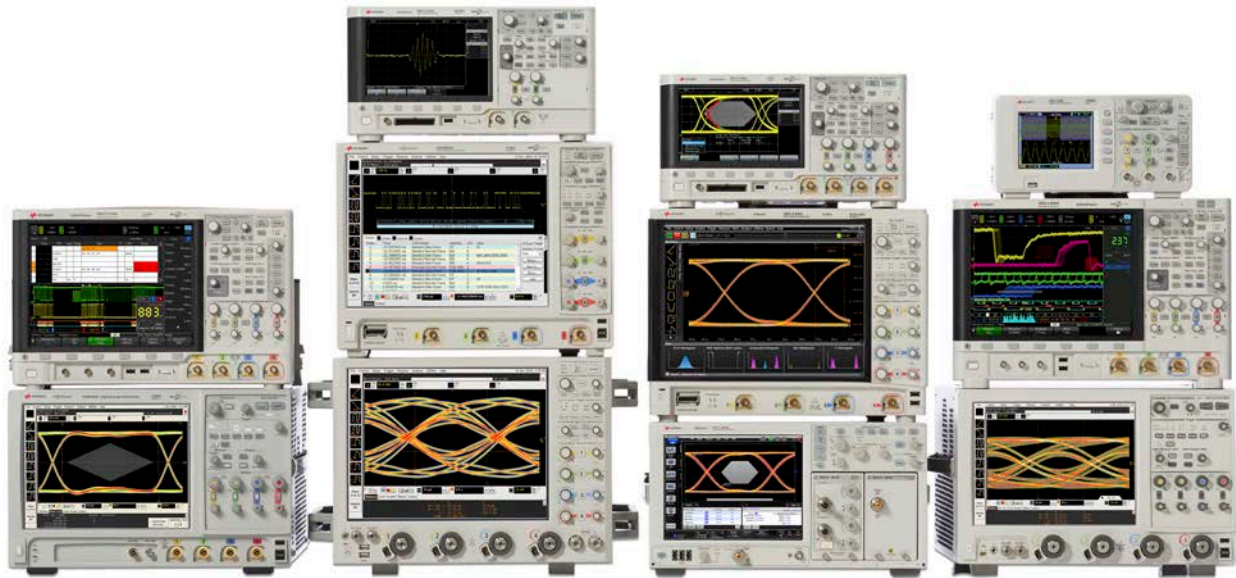

## Keysight Oscilloscopes

Multiple form factors from 20 MHz to > 90 GHz | Industry leading specs | Powerful applications



[www.axistandard.org](http://www.axistandard.org)

AdvancedTCA® Extensions for Instrumentation and Test (AXIe) is an open standard that extends the AdvancedTCA for general purpose and semiconductor test. The business that became Keysight was a founding member of the AXIe consortium. ATCA®, AdvancedTCA®, and the ATCA logo are registered US trademarks of the PCI Industrial Computer Manufacturers Group.



[www.lxistandard.org](http://www.lxistandard.org)

LAN eXtensions for Instruments puts the power of Ethernet and the Web inside your test systems. The business that became Keysight was a founding member of the LXI consortium.



[www.pxisa.org](http://www.pxisa.org)

PCI eXtensions for Instrumentation (PXI) modular instrumentation delivers a rugged, PC-based high-performance measurement and automation system.

## Download your next insight

Keysight software is downloadable expertise. From first simulation through first customer shipment, we deliver the tools your team needs to accelerate from data to information to actionable insight.

- Electronic design automation (EDA) software
- Application software
- Programming environments
- Productivity software



Learn more at

[www.keysight.com/find/software](http://www.keysight.com/find/software)

Start with a 30-day free trial.

[www.keysight.com/find/free\\_trials](http://www.keysight.com/find/free_trials)



## Evolving

Our unique combination of hardware, software, support, and people can help you reach your next breakthrough. **We are unlocking the future of technology.**

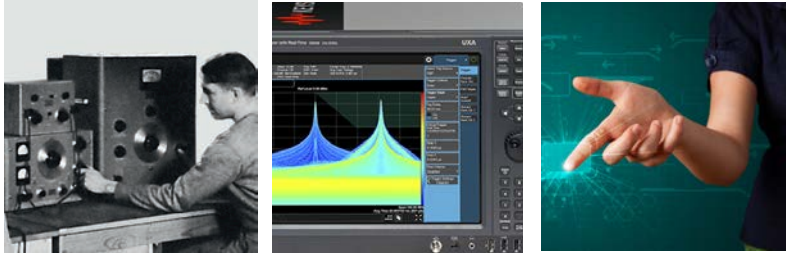

From Hewlett-Packard to Agilent to Keysight

### myKeysight

myKeysight

[www.keysight.com/find/mykeysight](http://www.keysight.com/find/mykeysight)

A personalized view into the information most relevant to you.

Keysight Infoline

### Keysight Infoline

[www.keysight.com/find/Infoline](http://www.keysight.com/find/Infoline)

Keysight's insight to best in class information management. Free access to your Keysight equipment company reports and e-library.

### KEYSIGHT SERVICES

Keysight Services

[www.keysight.com/find/service](http://www.keysight.com/find/service)

Our deep offering in design, test, and measurement services deploys an industry-leading array of people, processes, and tools. The result? We help you implement new technologies and engineer improved processes that lower costs.

Three-Year Warranty

[www.keysight.com/find/ThreeYearWarranty](http://www.keysight.com/find/ThreeYearWarranty)

Keysight's committed to superior product quality and lower total cost of ownership. Keysight is the only test and measurement company with three-year warranty standard on all instruments, worldwide. And, we provide a one-year warranty on many accessories, calibration devices, systems and custom products.

Keysight Assurance Plans

[www.keysight.com/find/AssurancePlans](http://www.keysight.com/find/AssurancePlans)

Up to ten years of protection and no budgetary surprises to ensure your instruments are operating to specification, so you can rely on accurate measurements.

Keysight Channel Partners

[www.keysight.com/find/channelpartners](http://www.keysight.com/find/channelpartners)

Get the best of both worlds: Keysight's measurement expertise and product breadth, combined with channel partner convenience.

PCI-SIG®, PCIe® and the PCI Express® are US registered trademarks and/or service marks of PCI-SIG.

[www.keysight.com/find/N5393D](http://www.keysight.com/find/N5393D)

For more information on Keysight Technologies' products, applications or services, please contact your local Keysight office. The complete list is available at: [www.keysight.com/find/contactus](http://www.keysight.com/find/contactus)

### Americas

Canada	(877) 894 4414
Brazil	55 11 3351 7010
Mexico	001 800 254 2440
United States	(800) 829 4444

### Asia Pacific

Australia	1 800 629 485
China	800 810 0189
Hong Kong	800 938 693
India	1 800 11 2626
Japan	0120 (421) 345
Korea	080 769 0800
Malaysia	1 800 888 848
Singapore	1 800 375 8100
Taiwan	0800 047 866
Other AP Countries	(65) 6375 8100

### Europe & Middle East

Austria	0800 001122
Belgium	0800 58580
Finland	0800 523252
France	0805 980333
Germany	0800 6270999
Ireland	1800 832700
Israel	1 809 343051
Italy	800 599100
Luxembourg	+32 800 58580
Netherlands	0800 0233200
Russia	8800 5009286
Spain	800 000154
Sweden	0200 882255
Switzerland	0800 805353
	Opt. 1 (DE)
	Opt. 2 (FR)
	Opt. 3 (IT)
United Kingdom	0800 0260637

For other unlisted countries:  
[www.keysight.com/find/contactus](http://www.keysight.com/find/contactus)  
(BP-06-08-16)

DEKRA Certified  
ISO 9001 Quality Management System

[www.keysight.com/go/quality](http://www.keysight.com/go/quality)  
Keysight Technologies, Inc.  
DEKRA Certified ISO 9001:2015  
Quality Management System