

Type AFK_V, -55 °C to 105 °C, High Vibration

SMT Aluminum Electrolytic Capacitors - Lowest E.S.R., 105 °C

Low Impedance and Long-Life for Filtering, Bypassing and Power Supply Decoupling

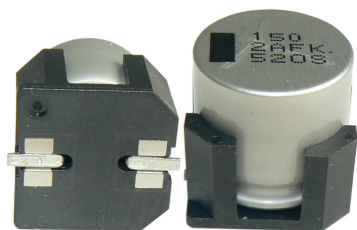

Using a ruggedized construction, type AFK_V withstands a 30 G vibration test and has 40% to 60% lower impedance, 30% to 50% smaller case size and more than twice the life compared to general purpose types. As the main countermeasure to vibration, the metal case is inserted into a molded plastic retaining wall that surrounds the part, keeping it firmly in place. Larger diameter leads provide additional mechanical stability of the internal winding and a larger soldering surface keeps the part firmly affixed to the PCB. Type AFK_V is an excellent choice for power systems subjected to frequent motion and vibration.

Highlights

- Withstands 30 G vibration test
- +105 °C, Up to 5000 Hour Load Life
- Capacitance Range: 10 µF to 6800 µF
- Voltage Range: 6.3 Vdc to 100 Vdc

Specifications

Capacitance Range	10 µF to 6800 µF								
Capacitance Tolerance	±20% @ 120 Hz and +20 °C								
Rated Voltage	6.3, 10, 16, 25, 35, 50, 63, 80 & 100 Vdc								
Operating Temperature Range	-55 °C to +105 °C								
Leakage Current	0.01 CV or 3 µA @ +20 °C, after two minutes (whichever is greater)								
Ripple Current Multiplier	Frequency	50/60 Hz	120 Hz	1 kHz	10 kHz	100 kHz			
		0.70	.0.75	0.90	0.95	1.00			
Dissipation Factor	6.3V	10V	16V	25V	35V	50V	63V	80V	100V
	0.26	0.19	0.16	0.14	0.12	0.1	0.08	0.08	0.07
Add 0.02 per 1000 µF for values greater than 1000 µF									
Low Temperature Impedance Ratio Characteristics at 120 Hz	Rated Voltage (Vdc)		6.3, 10, 16	25, 35, 50, 63, 80, 100					
	Z (-25°C)/Z(+20°C)		2	2					
	Z (-40°C)/Z(+20°C)		3	3					
	Z (-55°C)/Z(+20°C)		4	3					
Life Test	2000 h @ 105 °C, 8.0 — 10.0 mm dia. 5000 h @ 105 °C, 12.5 — 18.0 mm dia. Δ Capacitance ±30% DF: ≤ 200% of limit DCL: ≤ 100% of limit								
Shelf Test	1000 h @ 105 °C Δ Capacitance ±30% DF: ≤ 200% of limit DCL: ≤ 100% of limit								
High Vibration Test	Capacitors with the high vibration base will pass a 30 G acceleration test from 5 Hz to 2000 Hz with a max. amplitude of 5 mm (peak to peak) for 2 hours each in the X,Y and Z directions for a total of 6 hours. During the last 30 minutes of the test, the measured capacitance shall be stable. After the test the capacitor shall meet the following: ΔC at 120 Hz - Capacitance value will be within 5% of the initial value. There will be no significant change in appearance.								
RoHS Compliant									

Type AFK_V, -55 °C to 105 °C, High Vibration

SMT Aluminum Electrolytic Capacitors - Lowest E.S.R., 105 °C

AFK Series Marking

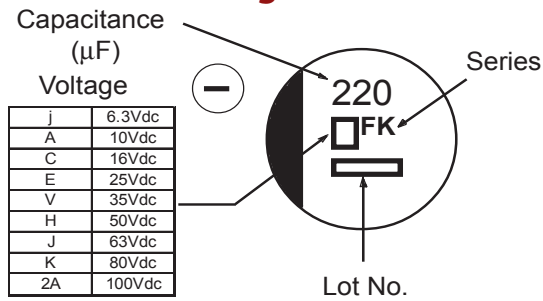

Outline Drawing

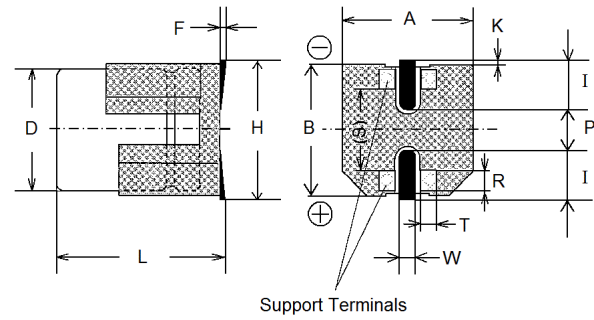

Case Dimensions

Size Code	D ± 0.5	L	A ± 0.2	B ± 0.2	H max.	F	I	w	P	K	R ± 0.2	S ± 0.2	T ± 0.2
E	8	6.5 ± 0.3	8.3	8.3	9.5	-1 to +0.15	3.4	0.7 ± 0.1	2.2	.35 ± 0.2	0.70	5.3	1.7
F	8	10.5 ± 0.3	8.3	8.3	10	-1 to +0.15	3.4	1.2 ± 0.2	3.1	.70 ± 0.2	0.70	5.3	1.3
G	10	10.5 ± 0.3	10.3	10.3	12	-1 to +0.15	3.5	1.2 ± 0.2	4.6	.70 ± 0.2	0.70	6.9	1.3
H	12.5	13.8 ± 0.5	13.5	13.5	15	-1 to +0.15	4.7	1.2 ± 0.3	4.4	.70 ± 0.3	2.2	7.1	2.4
P	16	16.8 ± 0.5	17	17	19	-1 to +0.15	5.5	1.4 ± 0.2	6.7	.70 ± 0.3	3.0	9.0	1.9
R	18	16.8 ± 0.5	19	19	21	-1 to +0.15	6.7	1.4 ± 0.2	6.7	.70 ± 0.3	3.0	11.0	1.9

Part Numbering System

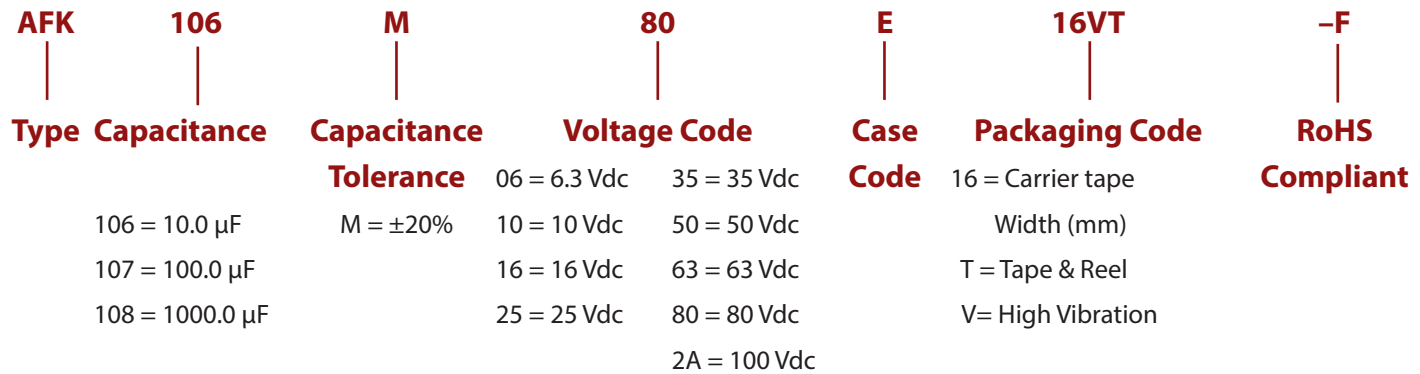

Typical Performance Curves

Capacitance vs. Temperature and Frequency
3300µF/6.3Vdc (12.5 x 13.5 mm)

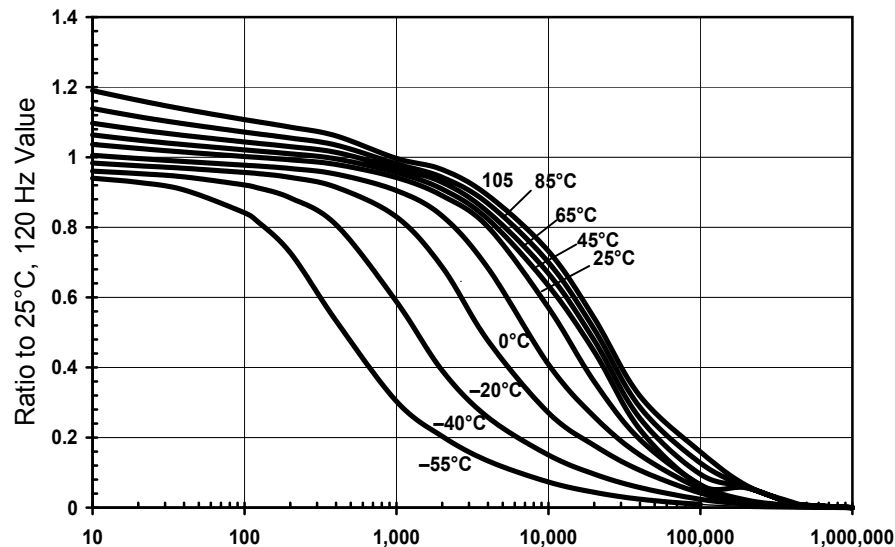

Type AFK_V, -55 °C to 105 °C, High Vibration SMT Aluminum Electrolytic Capacitors - Lowest E.S.R., 105 °C

Typical Performance Curves

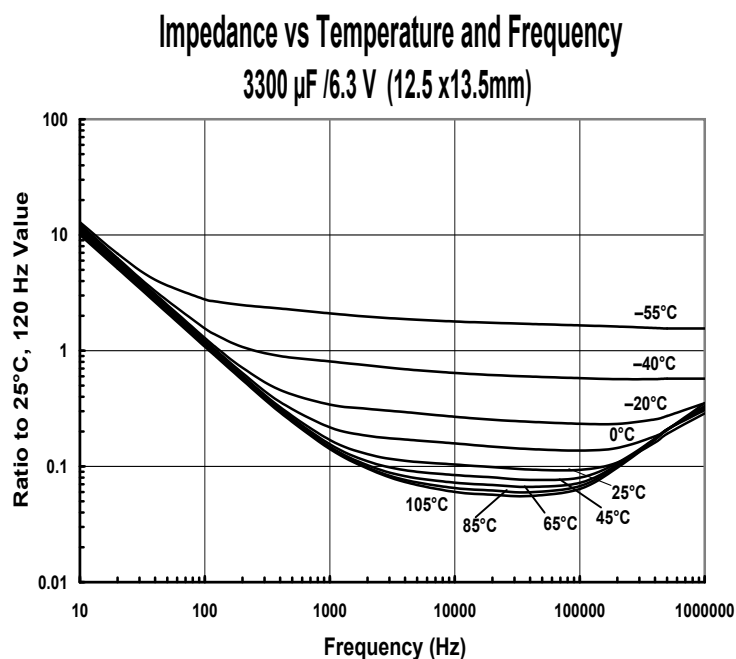
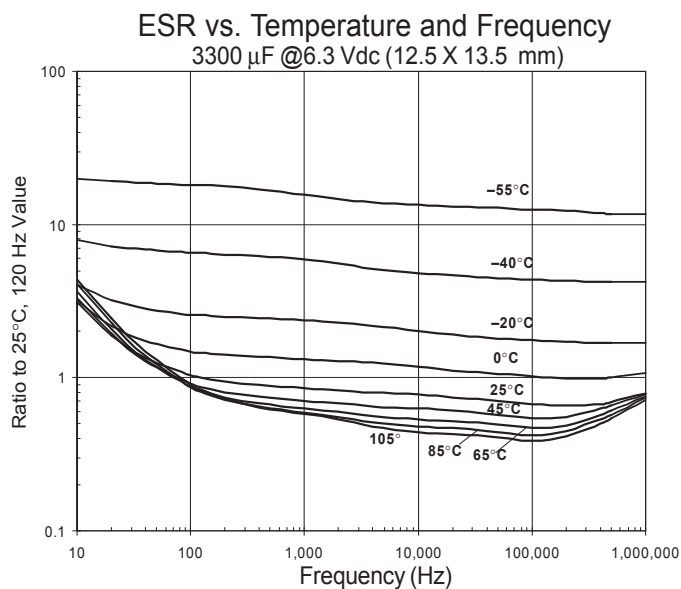

Ratings Table

Capacitance (μ F)	Catalog Part Number	Max. DCL 2 min. (μ A)	Max. Dissipation Factor @120 Hz/20°C	Max. ESR @100 kHz/20°C (Ω)	Impedance @100 kHz/20°C (Ω)	Max. Ripple Current @100 kHz/105°C (mA)	Case Code	Size D x L (mm)	Quantity per Reel
6.3 Vdc (8 Vdc Surge)									
330	AFK337M06E16VT-F	20.8	0.26	0.26	0.26	300	E	8 x 6.5	1000
470	AFK477M06F24VT-F	29.6	0.26	0.16	0.16	600	F	8 x 10.5	500
1000	AFK108M06F24VT-F	63	0.26	0.16	0.16	600	F	8 x 10.5	500
1500	AFK158M06G24VT-F	94.8	0.26	0.08	0.08	850	G	10 x 10.5	500
3300	AFK338M06H32VT-F	207.9	0.30	0.06	0.06	1100	H	12.5 x 13.8	200
6800	AFK688M06P44VT-F	428.4	0.36	0.035	0.035	1800	P	16 x 16.8	125
10 Vdc (13 Vdc Surge)									
220	AFK227M10E16VT-F	22	0.19	0.26	0.26	300	E	8 x 6.5	1000
330	AFK337M10F24VT-F	33	0.19	0.16	0.16	600	F	8 x 10.5	500
470	AFK477M10F24VT-F	47	0.19	0.16	0.16	600	F	8 x 10.5	500
680	AFK687M10F24VT-F	68	0.19	0.16	0.16	600	F	8 x 10.5	500
1000	AFK108M10G24VT-F	100	0.19	0.08	0.08	850	G	10 x 10.5	500
2200	AFK228M10H32VT-F	220	0.21	0.06	0.06	1100	H	12.5 x 13.8	200
4700	AFK478M10P44VT-F	470	0.25	0.035	0.035	1800	P	16 x 16.8	125
6800	AFK688M10R44VT-F	680	0.29	0.033	0.033	2060	R	18 x 16.8	125
16 Vdc (20 Vdc Surge)									
220	AFK227M16E16VT-F	35.2	0.16	0.26	0.26	300	E	8 x 6.5	1000
330	AFK337M16F24VT-F	52.8	0.16	0.16	0.16	600	F	8 x 10.5	500
470	AFK477M16F24VT-F	75.2	0.16	0.16	0.16	600	F	8 x 10.5	500
680	AFK687M16G24VT-F	108.8	0.16	0.08	0.08	850	G	10 x 10.5	500
1500	AFK158M16H32VT-F	240	0.16	0.06	0.06	1100	H	12.5 x 13.8	200
3300	AFK338M16P44VT-F	528	0.2	0.035	0.035	1800	P	16 x 16.8	125
4700	AFK478M16R44VT-F	752	0.22	0.033	0.033	2060	R	18 x 16.8	125

Type AFK_V, -55 °C to 105 °C, High Vibration

SMT Aluminum Electrolytic Capacitors - Lowest E.S.R., 105 °C

Capacitance (μF)	Catalog Part Number	Max. DCL 2 min. (μA)	Max. Dissipation Factor @120 Hz/20°C	Max. ESR @100 kHz/20°C (Ω)	Impedance @100 kHz/20°C (Ω)	Max. Ripple Current @100 kHz/105°C (mA)	Case Code	Size D x L (mm)	Quantity per Reel
25 Vdc (31 Vdc Surge)									
100	AFK107M25E16VT-F	25	0.14	0.26	0.26	300	E	8 x 6.5	1000
150	AFK157M25F24VT-F	37.5	0.14	0.16	0.16	600	F	8 x 10.5	500
220	AFK227M25F24VT-F	55	0.14	0.16	0.16	600	F	8 x 10.5	500
330	AFK337M25F24VT-F	82.5	0.14	0.16	0.16	600	F	8 x 10.5	500
470	AFK477M25G24VT-F	117.5	0.14	0.08	0.08	850	G	10 x 10.5	500
1000	AFK108M25H32VT-F	250	0.14	0.06	0.06	1100	H	12.5 x 13.8	200
1500	AFK158M25P44VT-F	375	0.14	0.035	0.035	1800	P	16 x 16.8	125
2200	AFK228M25P44VT-F	550	0.16	0.035	0.035	1800	P	16 x 16.8	125
3300	AFK338M25R44VT-F	825	0.18	0.033	0.033	2060	R	18 x 16.8	125
35 Vdc (44 Vdc Surge)									
100	AFK107M35F24VT-F	35	0.12	0.16	0.16	600	F	8 x 10.5	500
150	AFK157M35F24VT-F	52.5	0.12	0.16	0.16	600	F	8 x 10.5	500
220	AFK227M35F24VT-F	77	0.12	0.16	0.16	600	F	8 x 10.5	500
330	AFK337M35G24VT-F	115.5	0.12	0.08	0.08	850	G	10 x 10.5	500
470	AFK477M35H32VT-F	164.5	0.12	0.06	0.06	1100	H	12.5 x 13.8	200
680	AFK687M35H32VT-F	238	0.12	0.06	0.06	1100	H	12.5 x 13.8	200
1000	AFK108M35P44VT-F	350	0.12	0.035	0.035	1800	P	16 x 16.8	125
1500	AFK158M35P44VT-F	525	0.12	0.035	0.035	1800	P	16 x 16.8	125
50 Vdc (63 Vdc Surge)									
33	AFK336M50E16VT-F	16.5	0.1	0.68	0.68	195	E	8 x 6.5	1000
47	AFK476M50E16VT-F	23.5	0.1	0.68	0.68	195	E	8 x 6.5	1000
100	AFK107M50F24VT-F	50	0.1	0.34	0.34	350	F	8 x 10.5	500
150	AFK157M50G24VT-F	75	0.1	0.18	0.18	670	G	10 x 10.5	500
220	AFK227M50G24VT-F	110	0.1	0.18	0.18	670	G	10 x 10.5	500
330	AFK337M50H32VT-F	165	0.1	0.12	0.12	900	H	12.5 x 13.8	200
390	AFK397M50H32VT-F	195	0.1	0.12	0.12	900	H	12.5 x 13.8	200
470	AFK477M50P44VT-F	235	0.1	0.073	0.073	1610	P	16 x 16.8	125
560	AFK567M50P44VT-F	280	0.1	0.073	0.073	1610	P	16 x 16.8	125
680	AFK687M50P44VT-F	340	0.1	0.073	0.073	1610	P	16 x 16.8	125
1000	AFK108M50P44VT-F	500	0.1	0.073	0.073	1610	P	16 x 16.8	125
63 Vdc (75 Vdc Surge)									
22	AFK226M63E16VT-F	13.9	0.08	1.2	1.2	120	E	8 x 6.5	1000
33	AFK336M63F24VT-F	20.8	0.08	0.65	0.65	250	F	8 x 10.5	500
47	AFK476M63F24VT-F	29.6	0.08	0.65	0.65	250	F	8 x 10.5	500
68	AFK686M63G24VT-F	42.8	0.08	0.35	0.35	400	G	10 x 10.5	500
100	AFK107M63G24VT-F	63	0.08	0.35	0.35	400	G	10 x 10.5	500
150	AFK157M63H32VT-F	94.5	0.08	0.16	0.16	800	H	12.5 x 13.8	200
220	AFK227M63H32VT-F	138.6	0.08	0.16	0.16	800	H	12.5 x 13.8	200
470	AFK477M63P44VT-F	296.1	0.08	0.082	0.082	1410	P	16 x 16.8	125
680	AFK687M63R44VT-F	428.4	0.08	0.08	0.08	1690	R	18 x 16.8	125

Note: ≥50V, 8 and 10 mm Dia.; 235°C peak solder temperature

Type AFK_V, -55 °C to 105 °C, High Vibration

SMT Aluminum Electrolytic Capacitors - Lowest E.S.R., 105 °C

Capacitance (μF)	Catalog Part Number	Max. DCL 2 min. (μA)	Max. Dissipation Factor @120 Hz/20°C	Max. ESR @100 kHz/20°C (Ω)	Impedance @100 kHz/20°C (Ω)	Max. Ripple Current @100 kHz/105°C (mA)	Case Code	Size D x L (mm)	Quantity per Reel
80 Vdc (100 Vdc Surge)									
10	AFK106M80E16VT-F	8	0.08	2.4	2.4	60	E	8 x 6.5	1000
22	AFK226M80F24VT-F	17.6	0.08	1.3	1.3	130	F	8 x 10.5	500
33	AFK336M80F24VT-F	26.4	0.08	1.3	1.3	130	F	8 x 10.5	500
47	AFK476M80G24VT-F	37.6	0.08	0.7	0.7	200	G	10 x 10.5	500
68	AFK686M80H32VT-F	54.4	0.08	0.32	0.32	500	H	12.5 x 13.8	200
100	AFK107M80H32VT-F	80	0.08	0.32	0.32	500	H	12.5 x 13.8	200
150	AFK157M80H32VT-F	120	0.08	0.32	0.32	500	H	12.5 x 13.8	200
330	AFK337M80P44VT-F	264	0.08	0.17	0.17	793	P	16 x 16.8	125
470	AFK477M80R44VT-F	376	0.08	0.15	0.15	917	R	18 x 16.8	125
100 Vdc (125 Vdc Surge)									
22	AFK226M2AF24VT-F	22	0.07	1.3	1.3	130	F	8 x 10.5	500
33	AFK336M2AG24VT-F	33	0.07	0.7	0.7	200	G	10 x 10.5	500
47	AFK476M2AH32VT-F	47	0.07	0.32	0.32	500	H	12.5 x 13.8	200
68	AFK686M2AH32VT-F	68	0.07	0.32	0.32	500	H	12.5 x 13.8	200
100	AFK107M2AP44VT-F	100	0.07	0.17	0.17	793	P	16 x 16.8	125
150	AFK157M2AP44VT-F	150	0.07	0.17	0.17	793	P	16 x 16.8	125
220	AFK227M2AR44VT-F	220	0.07	0.15	0.15	917	R	18 x 16.8	125
330	AFK337M2AR44VT-F	330	0.07	0.15	0.15	917	R	18 x 16.8	125

Note: ≥50V, 8 and 10 mm Dia.; 235°C peak solder temperature

Reel Dimensions

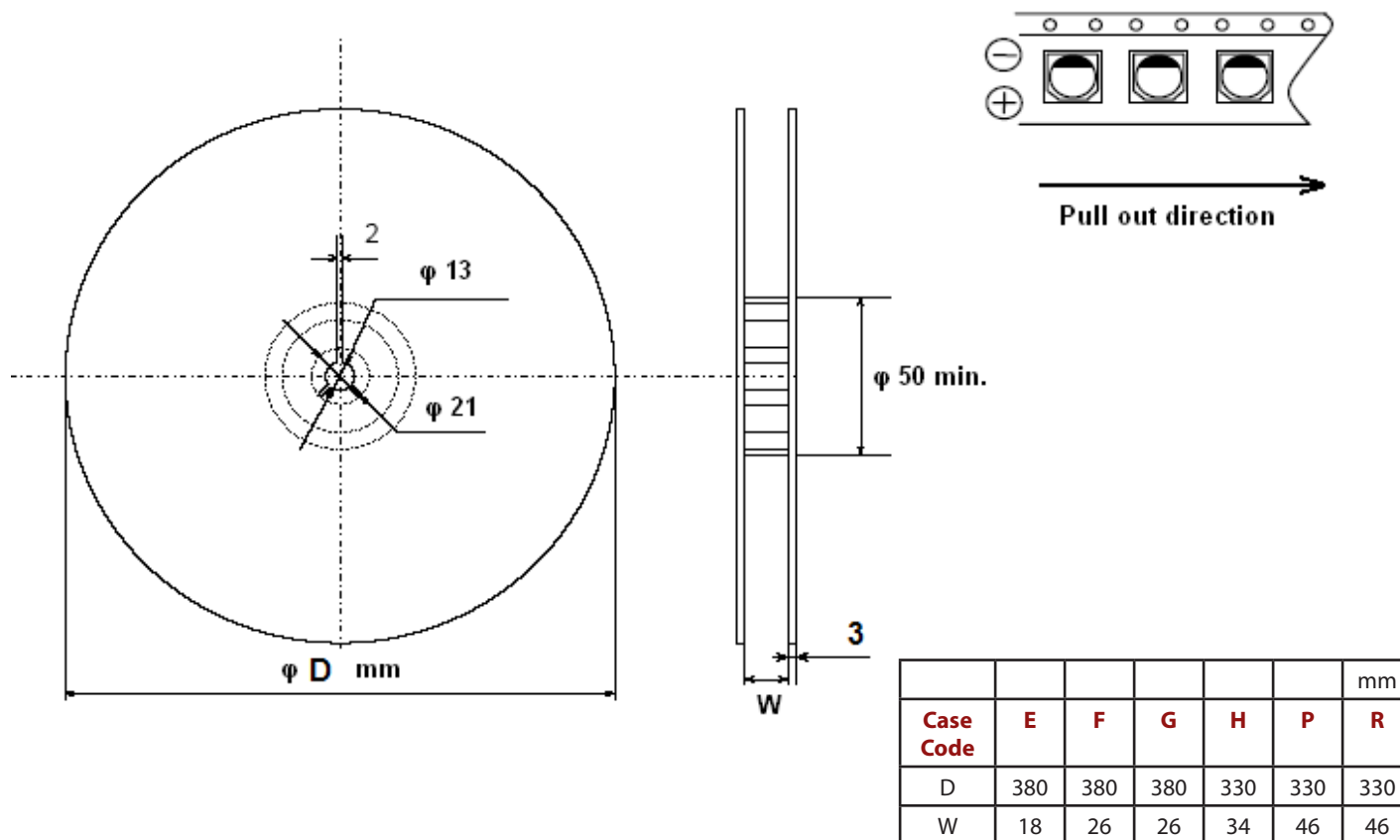

Type AFK_V, -55 °C to 105 °C, High Vibration

SMT Aluminum Electrolytic Capacitors - Lowest E.S.R., 105 °C

Case Code E, F and G Tape Dimensions

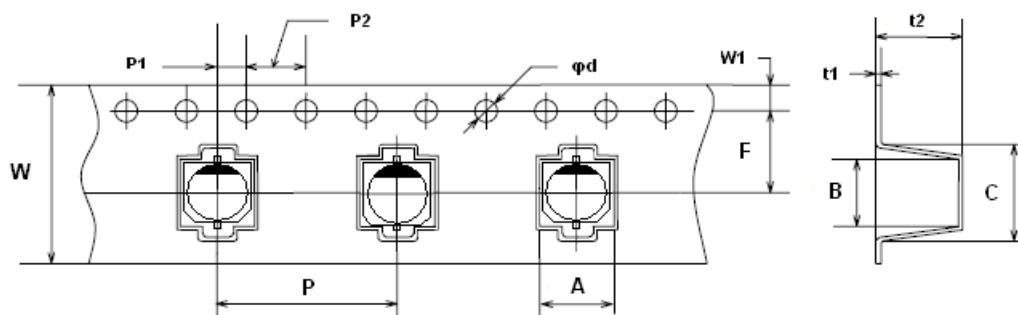

Case Size	Case Code	W ± 0.3	A ± 0.2	B +0.3/-0.2	C ± 0.2	F ± 0.1	P ± 0.1	t1	t2 ± 0.2	φd +0.1/-0	P1 ± 0.1	P2 ± 0.1	W1 ± 0.1
8 x 6.2	E	16	8.7	8.7	11.4	7.5	12	0.4	6.8	1.5	2	4	1.75
8 x 10.2	F	24	8.7	8.7	12.5	11.5	16		11				
10 x 10.2	G		10.7	10.7	14.5								

Recommended Land Dimensions

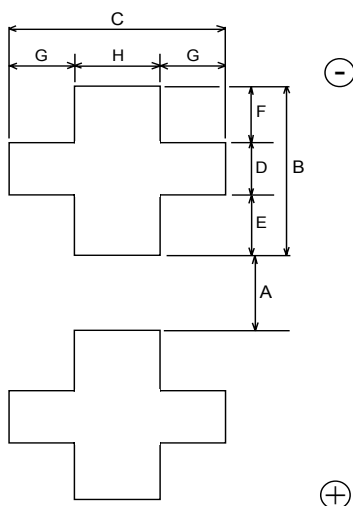

Case Code	Case Dia.	A	B	C	D	E	F	G	H
E	8	1.8	4.1	5.0	1.3	1.5	1.4	1.5	2.0
F	8	2.7	4.0	4.7	1.3	1.0	1.7	1.1	2.5
G	10	3.9	4.4	4.7	1.3	1.2	1.9	1.1	2.5
H	12.5	3.9	6.0	6.9	2.8	1.3	1.9	2.2	2.5
P	16	5.8	6.8	6.2	3.6	1.3	1.9	1.7	2.8
R	18	5.8	7.3	6.2	3.6	1.8	1.9	1.7	2.8

Case Code H, P and R Tape Dimensions

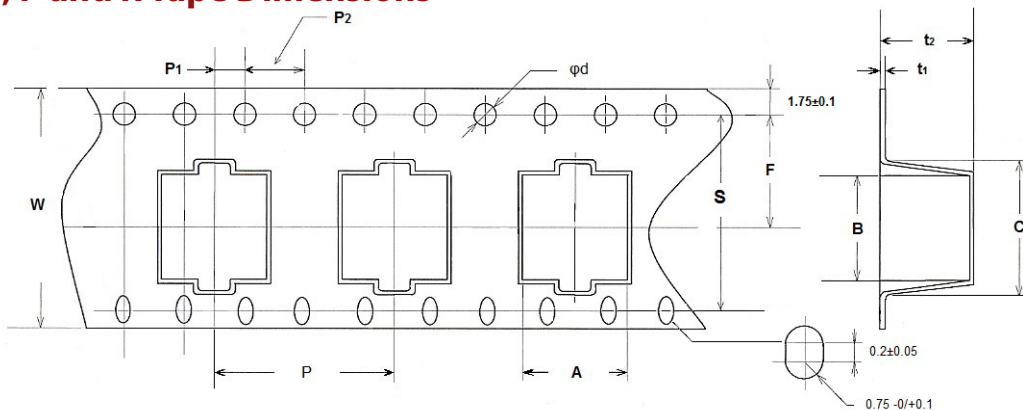

Case Size	Case Code	W ± 0.3	A ± 0.5	B ± 0.5	C ± 0.5	F ± 0.1	S ± 0.1	P ± 0.1	t1	t2 ± 0.2	φd +0.1/-0	P1 ± 0.1	P2 ± 0.1
12.5 x 13.5	H	32	14.0	14.0	18.0	14.2	28.4	24		14.5			
16 x 16.5	P	44	17.5	17.5	23.00	20.2	40.4	28	0.5	17.5	1.5	2	4
18 x 16.5	R		19.5	19.5	26.00			32					

Type AFK_V, -55 °C to 105 °C, High Vibration

SMT Aluminum Electrolytic Capacitors - Lowest E.S.R., 105 °C

Recommended Reflow Soldering

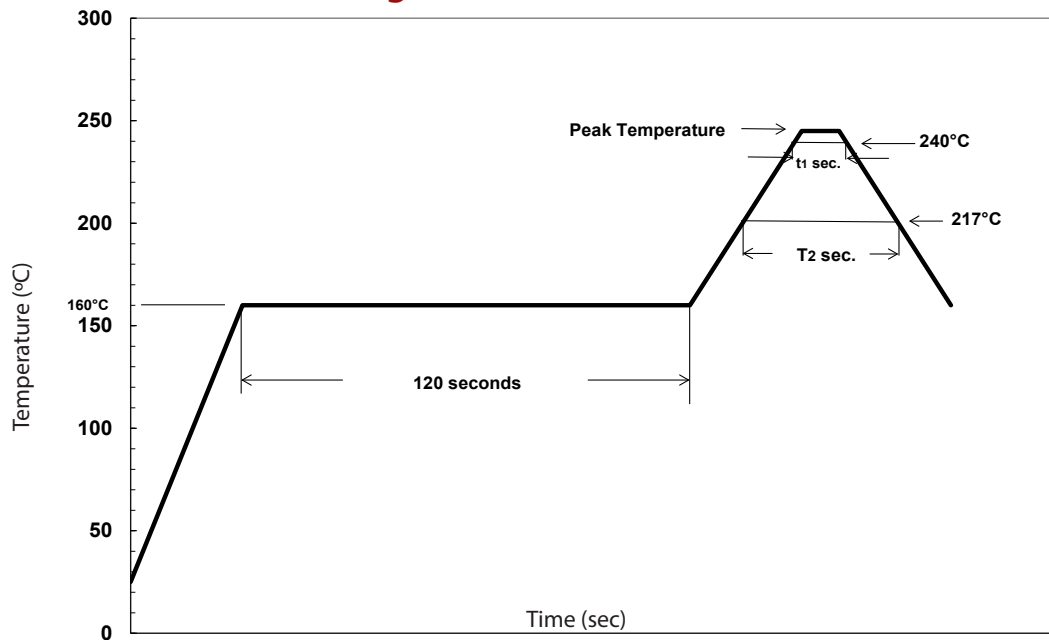

Case Code	Case Dia. (mm)	Voltage Rating	Peak Temperature	Time at or above 240°C (t1)	Time at or above 217°C (T2)	Number of Reflow Processes
H, P, R	12.5, 16, 18	6.3, 10, 16, 25, 35	245°C	30 seconds	90 seconds	2
		50, 63		5 seconds	30 seconds	2
		80, 100		5 seconds	30 seconds	1

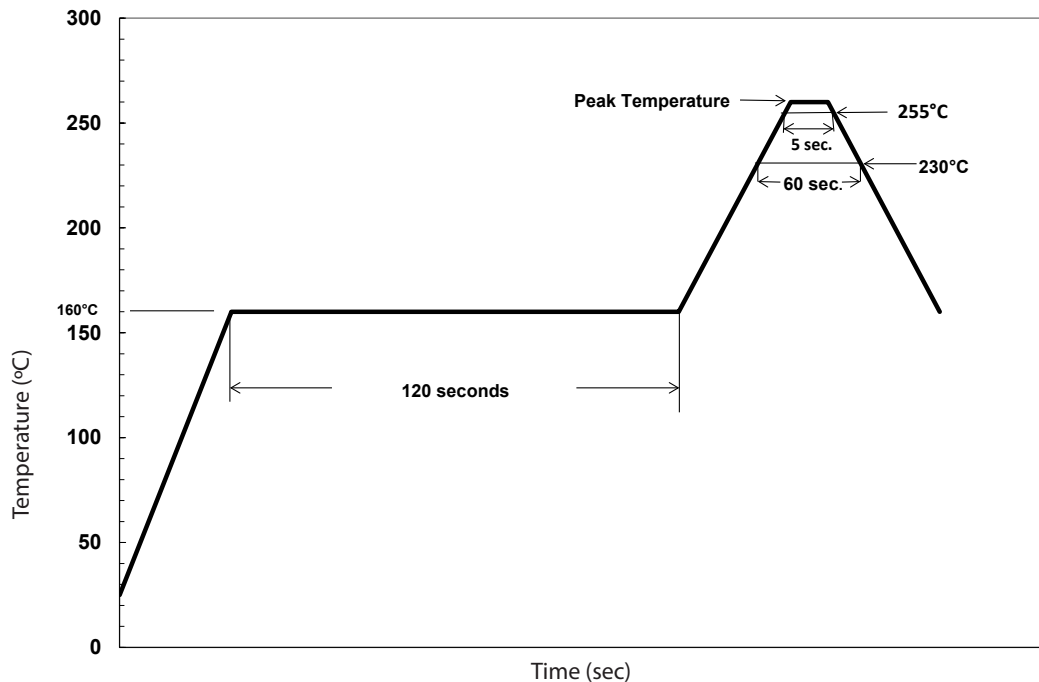

Case Code	Case Dia. (mm)	Voltage (Vdc)	Peak Temperature	Time at or above 255°C	Time at or above 230°C	Time at or above 200°C	Number of Reflow Processes
E	8	6.3, 10, 16, 25, 35	260°C	5 sec.	60 sec.	--	1
F	8						2
G	10						1
E, F, G	8, 10	50, 63, 80, 100	235°C	--	5 sec.	60 sec.	1

Type AFK_V, -55 °C to 105 °C, High Vibration

SMT Aluminum Electrolytic Capacitors - Lowest E.S.R., 105 °C

Notice and Disclaimer: All product drawings, descriptions, specifications, statements, information and data (collectively, the "Information") in this datasheet or other publication are subject to change. The customer is responsible for checking, confirming and verifying the extent to which the Information contained in this datasheet or other publication is applicable to an order at the time the order is placed. All Information given herein is believed to be accurate and reliable, but it is presented without any guarantee, warranty, representation or responsibility of any kind, expressed or implied. Statements of suitability for certain applications are based on the knowledge that the Cornell Dubilier company providing such statements ("Cornell Dubilier") has of operating conditions that such Cornell Dubilier company regards as typical for such applications, but are not intended to constitute any guarantee, warranty or representation regarding any such matter – and Cornell Dubilier specifically and expressly disclaims any guarantee, warranty or representation concerning the suitability for a specific customer application, use, storage, transportation, or operating environment. The Information is intended for use only by customers who have the requisite experience and capability to determine the correct products for their application. Any technical advice inferred from this Information or otherwise provided by Cornell Dubilier with reference to the use of any Cornell Dubilier products is given gratis (unless otherwise specified by Cornell Dubilier), and Cornell Dubilier assumes no obligation or liability for the advice given or results obtained. Although Cornell Dubilier strives to apply the most stringent quality and safety standards regarding the design and manufacturing of its products, in light of the current state of the art, isolated component failures may still occur. Accordingly, customer applications which require a high degree of reliability or safety should employ suitable designs or other safeguards (such as installation of protective circuitry or redundancies or other appropriate protective measures) in order to ensure that the failure of an electrical component does not result in a risk of personal injury or property damage. Although all product-related warnings, cautions and notes must be observed, the customer should not assume that all safety measures are indicated in such warnings, cautions and notes, or that other safety measures may not be required.