

描述 / Descriptions

TO-92 塑封封装 NPN 半导体三极管。Silicon NPN transistor in a TO-92 Plastic Package.

特征 / Features

耐压高。

High voltage.

用途 / Applications

用于高电压控制电路。

High voltage control circuit.

内部等效电路 / Equivalent Circuit

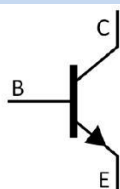

引脚排列 / Pinning



PIN1 : Collector PIN 2 : Base PIN 3 : Emitter

放大及印章代码 / hFE Classifications & Marking

见印章说明。See Marking Instructions.

极限参数 / Absolute Maximum Ratings(Ta=25°C)

参数 Parameter	符号 Symbol	数值 Rating	单位 Unit
Collector to Base Voltage	V_{CBO}	500	V
Collector to Emitter Voltage	V_{CEO}	400	V
Emitter to Base Voltage	V_{EBO}	6.0	V
Collector Current - Continuous	I_C	300	mA
Collector Power Dissipation	P_C	625	mW
Collector Power Dissipation	$P_C(T_C=25^\circ\text{C})$	1.5	W
Junction Temperature	T_j	150	°C
Storage Temperature Range	T_{stg}	-55~150	°C

电性能参数 / Electrical Characteristics(Ta=25°C)

参数 Parameter	符号 Symbol	测试条件 Test Conditions	最小值 Min	典型值 Typ	最大值 Max	单位 Unit
Collector to Base Breakdown Voltage	V_{CBO}	$I_C=100\mu\text{A}$ $I_E=0$	500			V
Collector to Emitter Breakdown Voltage	V_{CEO}	$I_C=1.0\text{mA}$ $I_B=0$	400			V
Emitter to Base Breakdown Voltage	V_{EBO}	$I_E=10\mu\text{A}$ $I_C=0$	6.0			V
Collector Cut-Off Current	I_{CBO}	$V_{CB}=400\text{V}$ $I_E=0$			0.1	μA
Collector Cut-Off Current	I_{CEO}	$V_{CE}=400\text{V}$ $V_{BE}=0$			0.5	μA
Emitter Cut-Off Current	I_{EBO}	$V_{EB}=4.0\text{V}$ $I_C=0$			0.1	μA
DC Current Gain	$h_{FE(1)}$	$V_{CE}=10\text{V}$ $I_C=10\text{mA}$	50		200	
	$h_{FE(2)}$	$V_{CE}=10\text{V}$ $I_C=100\text{mA}$	40			
	$h_{FE(3)}$	$V_{CE}=10\text{V}$ $I_C=50\text{mA}$	45			
	$h_{FE(4)}$	$V_{CE}=10\text{V}$ $I_C=1.0\text{mA}$	40			
Collector to Emitter Saturation Voltage	$V_{CE(sat)(1)}$	$I_C=1.0\text{mA}$ $I_B=0.1\text{mA}$			0.4	V
	$V_{CE(sat)(2)}$	$I_C=10\text{mA}$ $I_B=1.0\text{mA}$			0.5	V
	$V_{CE(sat)(3)}$	$I_C=50\text{mA}$ $I_B=5.0\text{mA}$			0.75	V
Base to Emitter Saturation Voltage	$V_{BE(sat)}$	$I_C=10\text{mA}$ $I_B=1.0\text{mA}$			0.75	V
Output Capacitance	C_{ob}	$V_{CB}=20\text{V}$ $I_E=0$ $f=1.0\text{MHz}$			7.0	pF

电参数曲线图 / Electrical Characteristic Curve

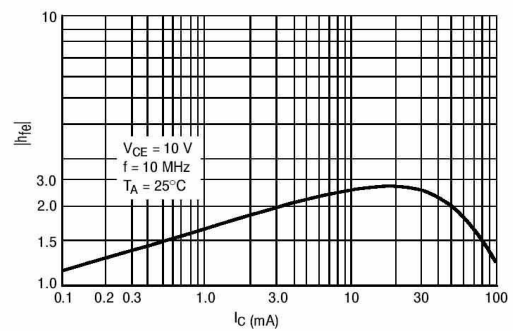
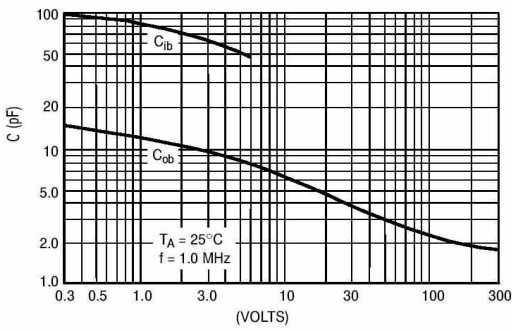
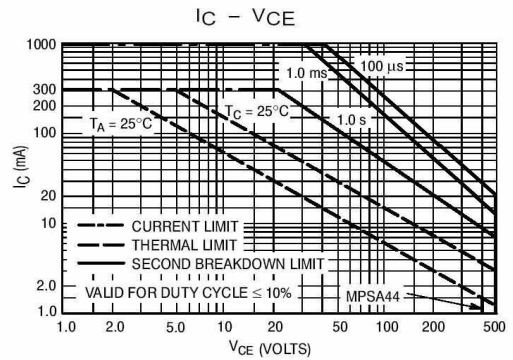
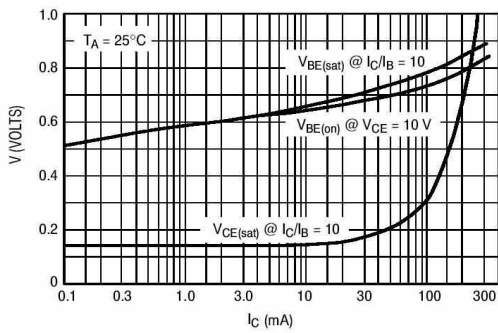
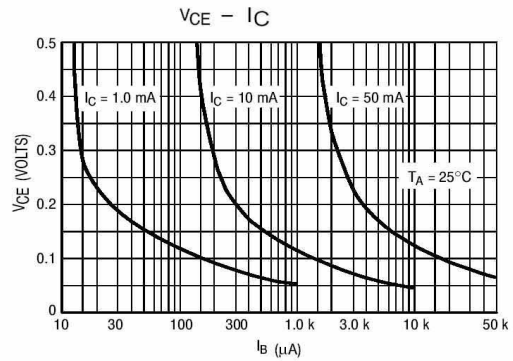
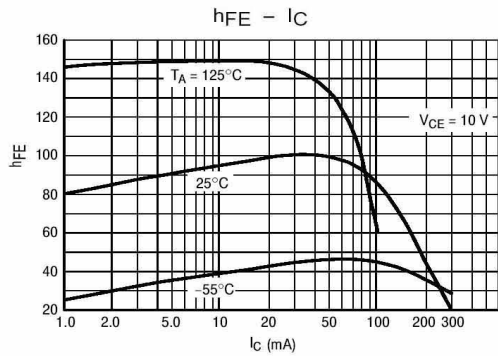

外形尺寸图 / Package Dimensions

TO-92

Unit: mm

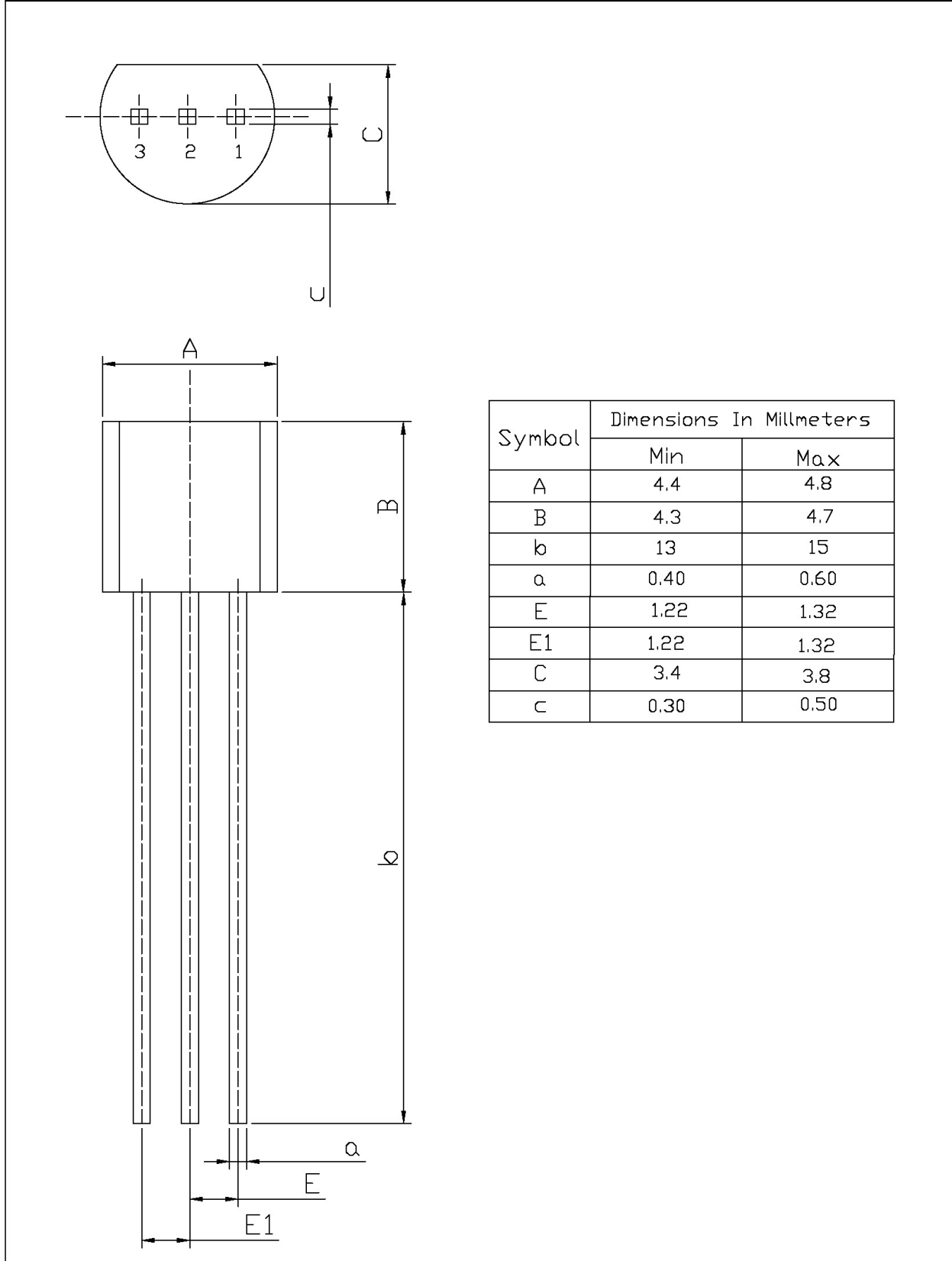

Symbol	Dimensions In Millimeters	
	Min	Max
A	4.4	4.8
B	4.3	4.7
b	13	15
a	0.40	0.60
E	1.22	1.32
E1	1.22	1.32
C	3.4	3.8
c	0.30	0.50

印章说明 / Marking Instructions

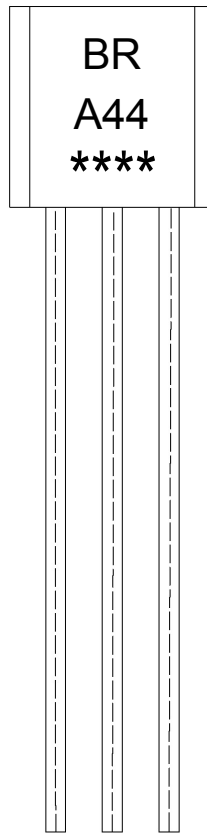

说明：

- BR: 为公司代码
- A44 : 为型号代码
- **** : 为生产批号代码，随生产批号变化。

Note:

- BR: Company Code.
- A44: Product Type.
- ****: Lot No. Code,code change with Lot No.

波峰焊温度曲线图(无铅) / Temperature Profile for Dip Soldering(Pb-Free)



说明：

- 1、预热温度 25 ~ 150°C，时间 60 ~ 90sec;
- 2、峰值温度 255±5°C，时间持续为 5±0.5sec;
- 3、焊接制程冷却速度为 2 ~ 10°C/sec.

Note:

- 1.Preheating:25~150°C, Time:60~90sec.
- 2.Peak Temp.:255±5°C, Duration:5±0.5sec.
3. Cooling Speed: 2~10°C/sec.

耐焊接热试验条件 / Resistance to Soldering Heat Test Conditions

温度：270±5°C 时间：10±1 sec. Temp:270±5°C Time:10±1 sec

包装规格 / Packaging SPEC.

散件包装 / BULK

Package Type 封装形式	Units 包装数量					Dimension 包装尺寸 (unit: mm3)		
	Units/Bag 只/袋	Bags/Inner Box 袋/盒	Units/Inner Box 只/盒	Inner Boxes/Outer Box 盒/箱	Units/Outer Box 只/箱	Bag 袋	Inner Box 盒	Outer Box 箱
TO-92	1,000	10	10,000	5	50,000	135×190	237×172×102	560×245×195
	1,000	10	10,000	10	100,000	135×190	237×172×102	560×245×375

编带包装 / AMMO

Package Type 封装形式	Units 包装数量					Dimension 包装尺寸 (unit: mm3)	
	Units/tape 只/纸带	Tape/Inner Box 纸带/盒	Rows/Inner Box 纸带层/盒	Inner Boxes/Outer Box 盒/箱	Units/Outer Box 只/箱	Inner Box 盒	Outer Box 箱
TO-92	3,000	1	120	10	30,000	328×230×42	小箱 480×346×235, 大箱 547×407×268

使用说明 / Notices