

**VOLTAGE RANGE: 100 - 1000V**  
**CURRENT: 1.0A**

### Features

- Glass passivated device
- Ideal for surface mounted applications
- Low reverse leakage
- Metallurgically bonded construction
- High temperature soldering guaranteed:
- 250°C/10 seconds, 0.375" (9.5mm) lead length, 5 lbs. (2.3kg) tension

### Mechanical Data

- Case: SOD-123FL  
plastic body over passivated junction
- Terminals: Plated axial leads,
- solderable per MIL-STD-750, Method 2026
- Polarity: Color band denotes cathode end
- Mounting Position: Any
- Weight: 0.0007 ounce, 0.02 grams

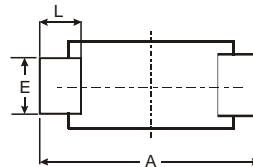
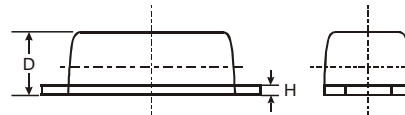
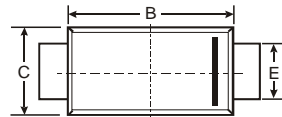
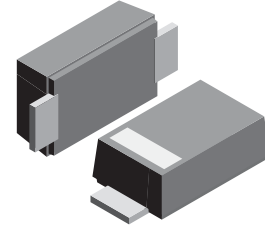

SOD-123FL			
Dim	Min	Max	Typ
A	3.58	3.72	3.65
B	2.72	2.78	2.75
C	1.77	1.83	1.80
D	1.02	1.08	1.05
E	0.097	1.03	1.00
H	0.13	0.17	0.15
L	0.53	0.57	0.55
All Dimensions in mm			

### Maximum Ratings and Electrical Characteristics $T_A = 25^\circ\text{C}$ unless otherwise specified

Single phase, half wave, 60Hz, resistive or inductive load. For capacitive load, derate current by 20%.

Characteristic	Symbol	SOD1F1	SOD1F2	SOD1F4	SOD1F6	SOD1F8	SOD1F10	Unit
Maximum repetitive peak reverse voltage	$V_{RRM}$	100	200	400	600	800	1000	V
Maximum RMS voltage	$V_{RMS}$	70	140	280	420	560	700	V
Maximum DC blocking voltage	$V_{DC}$	100	200	400	600	800	1000	V
Maximum average forward rectified current at $T_A=65^\circ\text{C}$ (NOTE 1)	$I_{(AV)}$	1.0						A
Peak forward surge current 8.3ms single half sine-wave superimposed on rated load (JEDEC Method) $T_L=25^\circ\text{C}$	$I_{FSM}$	30.0						A
Maximum instantaneous forward voltage at 1.0A	$V_F$	1.3						V
Maximum DC reverse current $T_A=25^\circ\text{C}$ at rated DC blocking voltage $T_A=100^\circ\text{C}$	$I_R$	5.0 100.0						$\mu\text{A}$
Maximum reverse recovery time (NOTE 2)	$t_{rr}$	150		250		500		ns
Typical junction capacitance (NOTE 3)	$C_J$	15						pF
Typical thermal resistance (NOTE 4)	$R_{\theta JA}$	180						K/W
Operating junction and storage temperature range	$T_J, T_{STG}$	-50 to +150						$^\circ\text{C}$

- Note:** 1. Averaged over any 20ms period.  
 2. Measured with  $I_F=0.5\text{A}$ ,  $I_R=1\text{A}$ ,  $I_{rr}=0.25\text{A}$ .  
 3. Measured at 1MHz and applied reverse voltage of 4.0V D.C.  
 4. Thermal resistance junction to ambient, 6.0 mm<sup>2</sup> copper pads to each terminal.

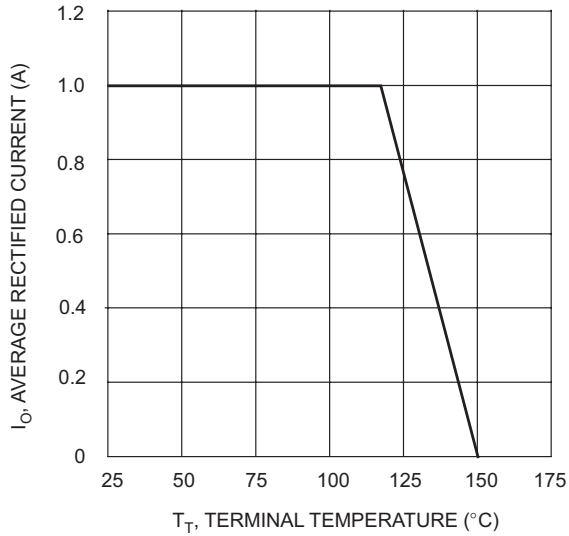

$T_T$ , TERMINAL TEMPERATURE (°C)  
Fig. 1 Forward Current Derating Curve

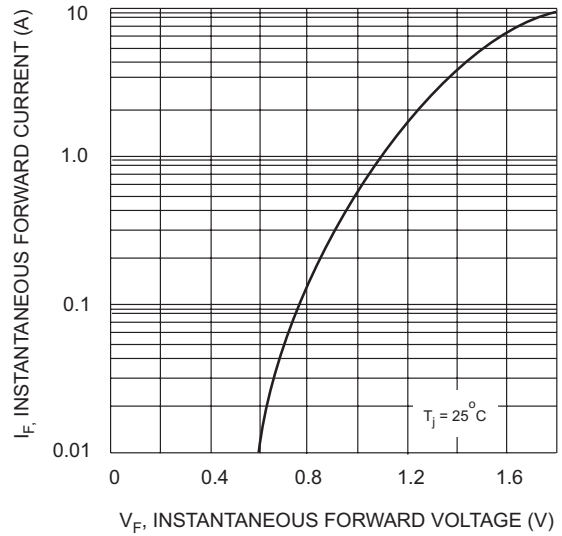

$V_F$ , INSTANTANEOUS FORWARD VOLTAGE (V)  
Fig. 2 Typical Forward Characteristics

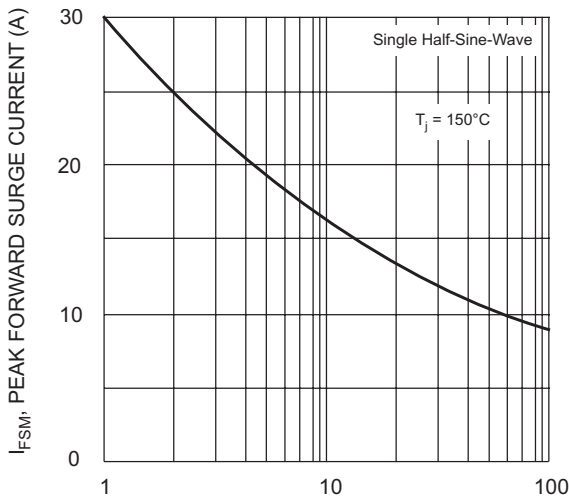

NUMBER OF CYCLES AT 60Hz  
Fig. 3 Forward Surge Current Derating Curve

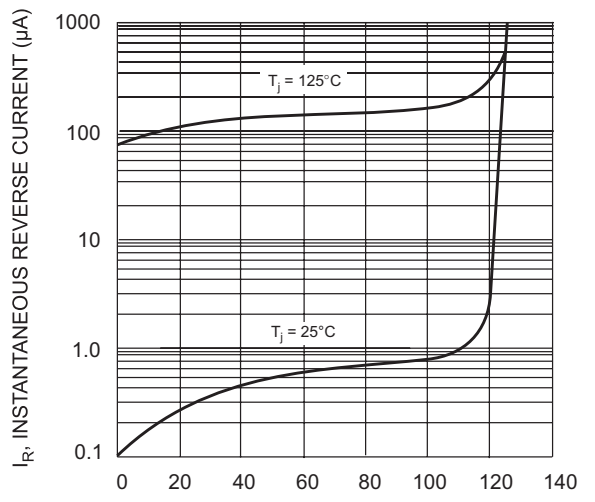

PERCENT OF RATED PEAK REVERSE VOLTAGE (%)  
Fig. 4 Typical Reverse Characteristics

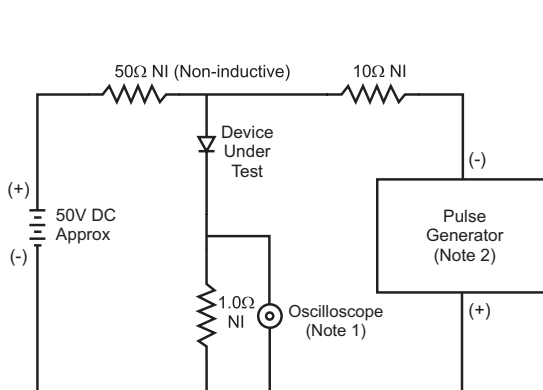

Notes:  
1. Rise Time = 7.0ns max. Input Impedance = 1.0M $\Omega$ , 22pF.  
2. Rise Time = 10ns max. Input Impedance = 50 $\Omega$ .

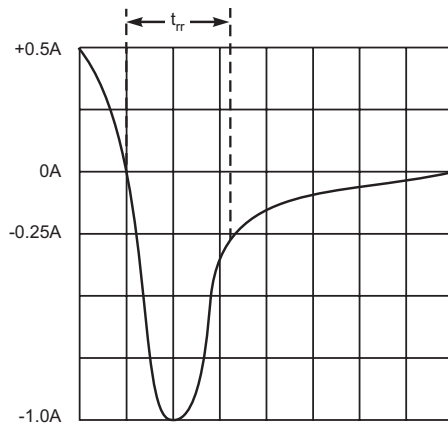

Set time base for 50/100 ns/cm

Fig. 5 Reverse Recovery Time Characteristic and Test Circuit